

## FEATURES AND SPECIFICATIONS

### Features and Benefits

- "Offset Terminal Retention" for optimum retention to PC board during wave soldering
- Fully polarized to mating receptacle
- Peg feature provides polarization to PCB
- Surface Mount Compatible

### Reference Information

Product Specification: PS-43650  
 Packaging: Tray  
 UL File No.: E29179  
 CSA File No.: LR19980  
 TUV License No.: R95107  
 Mates With: [43645](#)  
 Designed In: Millimeters

### Electrical

Voltage: 250V  
 Current: 5.0A max.  
 Contact Resistance: 10mΩ max.  
 Dielectric Withstanding Voltage: 1500V AC  
 Insulation Resistance: 1000 MΩ min.

### Mechanical

Insertion Force to PCB: 7.5kgf max. (16.5 lb)

### Physical

Housing: High temperature LCP, UL 94V-0  
 Contact: Brass  
 Plating: Tin or Gold

# molex® 3.00mm (.118") Pitch Micro-Fit 3.0™ Wire-to-Board Header

## 43650 Single Row Vertical

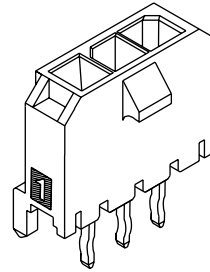

## CATALOG DRAWING (FOR REFERENCE ONLY)

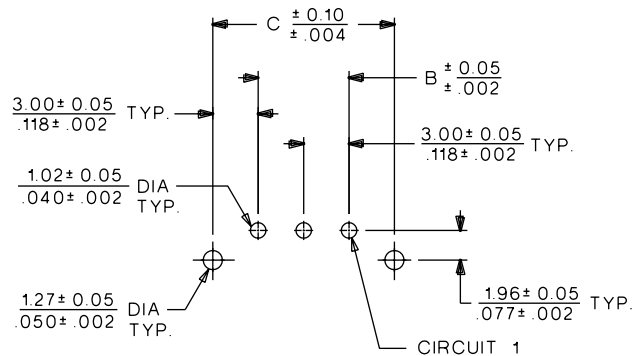
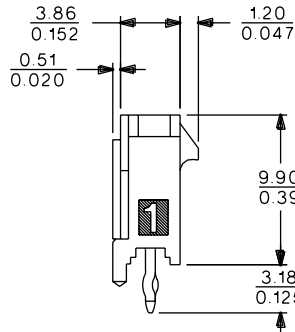
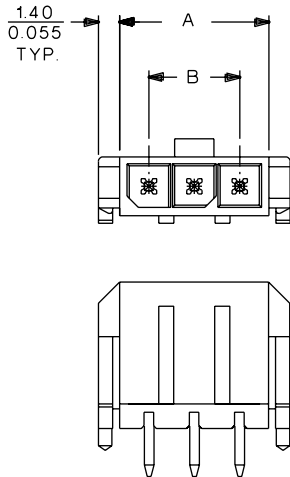

PCB LAYOUT: COMPONENT SIDE

RECOMMENDED PCB THICKNESS =  $\frac{1.57}{.062}$

## ORDERING INFORMATION AND DIMENSIONS

Circuits	Order No.						Dimension		
	Standard "OTR" Version			Straight Tail Version			A	B	C
	Tin	15μ" Gold	30μ" Gold	Tin	15μ" Gold	30μ" Gold			
2	43650-0215	43650-0216	43650-0217	43650-0227	43650-0228	43650-0229	6.85 (.270)	3.00 (.118)	9.00 (.354)
3	43650-0315	43650-0316	43650-0317	43650-0327	43650-0328	43650-0329	9.85 (.388)	6.00 (.236)	12.00 (.472)
4	43650-0415	43650-0416	43650-0417	43650-0427	43650-0428	43650-0429	12.85 (.506)	9.00 (.354)	15.00 (.591)
5	43650-0515	43650-0516	43650-0517	43650-0527	43650-0528	43650-0529	15.85 (.624)	12.00 (.472)	18.00 (.708)
6	43650-0615	43650-0616	43650-0617	43650-0627	43650-0628	43650-0629	18.85 (.742)	15.00 (.591)	21.00 (.827)
7	43650-0715	43650-0716	43650-0717	43650-0727	43650-0728	43650-0729	21.85 (.860)	18.00 (.709)	24.00 (.945)
8	43650-0815	43650-0816	43650-0817	43650-0827	43650-0828	43650-0829	24.85 (.978)	21.00 (.827)	27.00 (1.063)
9	43650-0915	43650-0916	43650-0917	43650-0927	43650-0928	43650-0929	27.85 (1.096)	24.00 (.945)	30.00 (1.181)
10	43650-1015	43650-1016	43650-1017	43650-1027	43650-1028	43650-1029	30.85 (1.215)	27.00 (1.063)	33.00 (1.299)
11	43650-1115	43650-1116	43650-1117	43650-1127	43650-1128	43650-1129	33.85 (1.333)	30.00 (1.181)	36.00 (1.417)
12	43650-1215	43650-1216	43650-1217	43650-1227	43650-1228	43650-1229	36.85 (1.451)	33.00 (1.299)	39.00 (1.535)

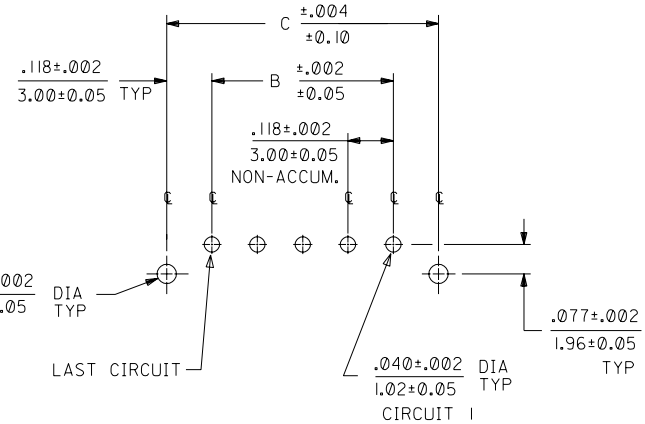
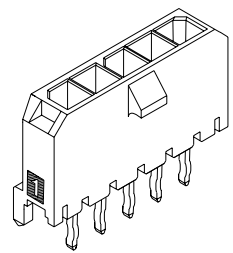
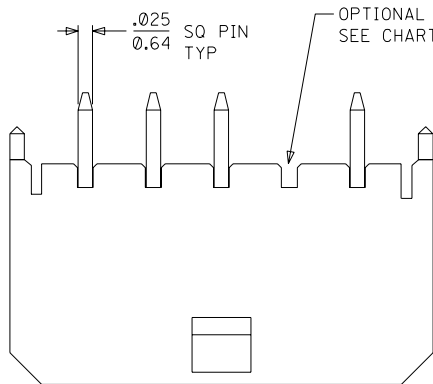

PCB LAYOUT: COMPONENT SIDE  
RECOMMENDED PCB THICKNESS: .062/1.57

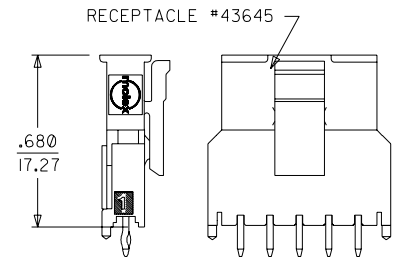
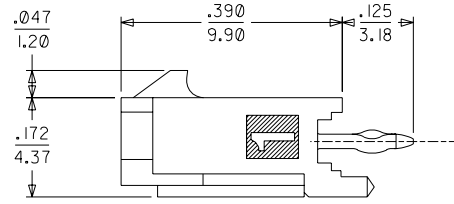
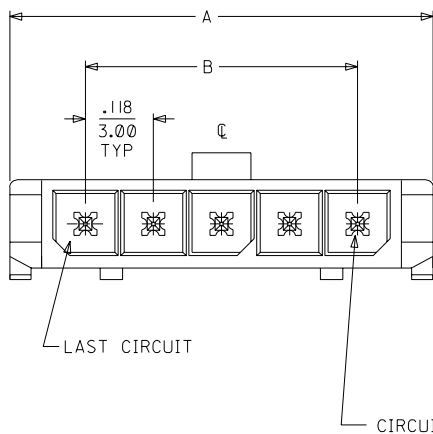

MATED MICRO FIT CONNECTORS

43650			
CKTS	A	B	C
2	.380	.118	.354
	9.65	3.00	9.00
3	.498	.236	.472
	12.65	6.00	12.00
4	.616	.354	.591
	15.65	9.00	15.00
5	.734	.472	.709
	18.64	12.00	18.00
6	.852	.591	.827
	21.64	15.00	21.00
7	.970	.709	.945
	24.64	18.00	24.00
8	1.088	.827	1.063
	27.64	21.00	27.00
9	1.206	.945	1.181
	30.63	24.00	30.00
10	1.325	1.063	1.299
	33.66	27.00	33.00
11	1.443	1.181	1.417
	36.65	30.00	36.00
12	1.561	1.299	1.535
	39.65	33.00	39.00

CKTS	FINISH A		FINISH B		FINISH C	
	MATERIAL NO:	VOID CKT	MATERIAL NO:	VOID CKT	MATERIAL NO:	VOID CKT
02	43650-0215		43650-0216		43650-0217	
03	43650-0315		43650-0316		43650-0317	
04	43650-0415		43650-0416		43650-0417	
05	43650-0515		43650-0516		43650-0517	
06	43650-0615		43650-0616		43650-0617	
07	43650-0715		43650-0716		43650-0717	
08	43650-0815		43650-0816		43650-0817	
09	43650-0915		43650-0916		43650-0917	
10	43650-1015		43650-1016		43650-1017	
11	43650-1115		43650-1116		43650-1117	
12	43650-1215		43650-1216		43650-1217	
03	43650-0330	02				
05	43650-9915	03				

- NOTES:
- HOUSING MATERIAL: LIQUID CRYSTAL POLYMER, GLASS FILLED, UL94V-0, COLOR: BLACK  
TERMINAL MATERIAL: BRASS ALLOY
  - FINISH:  
A = .000100/(0.0025) MIN TIN/LEAD (90/10) OVER .000050/(0.0013) NICKEL PLATE.  
B = .000015/(0.00038) MIN GOLD IN SELECTIVE AREA; .000050/(0.0013) MIN TIN/LEAD (90/10) ON SOLDER TAILS BOTH OVER .000050/(0.0013) NICKEL PLATE.  
C = .000030/(0.00076) MIN GOLD IN SELECTIVE AREA; .000050/(0.0013) MIN TIN/LEAD (90/10) ON SOLDER TAILS BOTH OVER .000050/(0.0013) NICKEL PLATE.
  - PRODUCT SPECIFICATION: PS-43650
  - MATES WITH MICRO FIT (3.0) RECEPTACLE SERIES 43645
  - TRAY PACKAGED : SEE MOLEX DRAWING PK-70873-0811

ADD VOID OPT EC NO. UCR2002-0861 DRAWN: SAMIEC 04/19/02 CHK: MUELLER 04/19/02 APPROVED: EDGLEY 04/19/02	QUALITY SYMBOLS MAJOR $\nabla = 0$ CRITICAL $\nabla = 0$	GENERAL TOLERANCES: (UNLESS SPECIFIED)	SCALE :	DESIGN UNITS <input checked="" type="checkbox"/> mm <input type="checkbox"/> INCH	THIRD ANGLE PROJECTION <input type="checkbox"/> mm <input checked="" type="checkbox"/> INCH <input type="checkbox"/> mm ONLY	SHT	REV
		4 PLACES $\pm 0.$ $\pm .$	DRAWN BY & DATE SAMIEC 00/07/07	TITLE: MICRO-FIT (3.0) SINGLE ROW / VERTICAL THRU HOLE / PEGS / TRAY		REVISE ON CAD ONLY	
		3 PLACES $\pm 0.$ $\pm .010$	CHECKED BY & DATE MUELLER 00/07/07	APPROVED BY & DATE EDGLEY 00/07/07	MATERIAL NO. SEE CHART	DRAWING NO. SD-43650-006	SHEET NO. 1 OF 1
		2 PLACES $\pm 0.25$ $\pm .014$	CAD FILENAME		THIS DRAWING CONTAINS INFORMATION THAT IS PROPRIETARY TO MOLEX INCORPORATED AND SHOULD NOT BE USED WITHOUT WRITTEN PERMISSION.		
		1 PLACE $\pm 0.36$ $\pm .$					SIZE C
		ANGULAR: $\pm 1/2^\circ$					

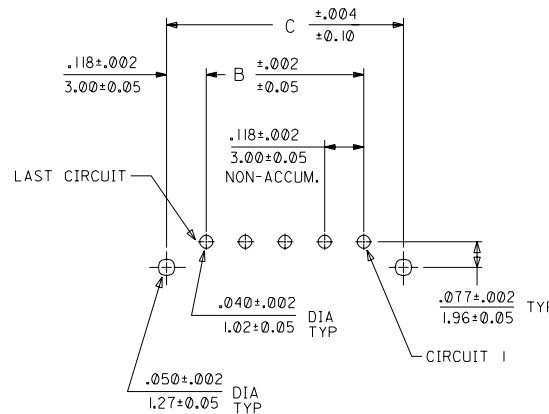
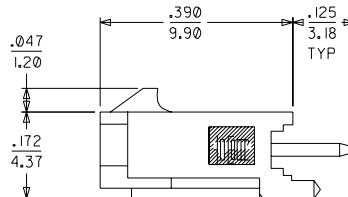
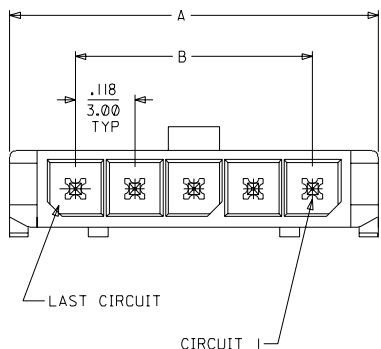
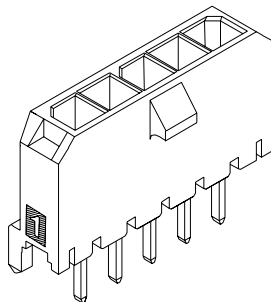
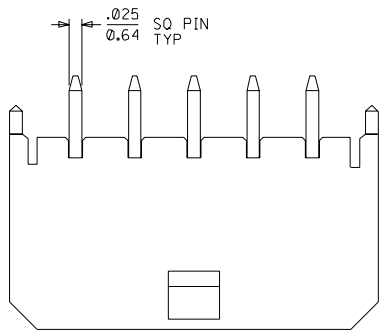

PCB LAYOUT: COMPONENT SIDE  
RECOMMENDED PCB THICKNESS: .062/1.57

CKTS	43650		
	A	B	C
2	.380	.118	.354
	9.65	3.00	9.00
3	.498	.236	.472
	12.65	6.00	12.00
4	.616	.354	.591
	15.65	9.00	15.00
5	.734	.472	.709
	18.64	12.00	18.00
6	.852	.591	.827
	21.64	15.00	21.00
7	.970	.709	.945
	24.64	18.00	24.00
8	1.088	.827	1.063
	27.64	21.00	27.00
9	1.206	.945	1.181
	30.63	24.00	30.00
10	1.325	1.063	1.299
	33.66	27.00	33.00
11	1.443	1.181	1.417
	36.65	30.00	36.00
12	1.561	1.299	1.535
	39.65	33.00	39.00

NOTES:

- HOUSING MATERIAL: LIQUID CRYSTAL POLYMER, GLASS FILLED, UL94V-0, COLOR: BLACK  
TERMINAL MATERIAL: BRASS ALLOY
- FINISH:
  - 194 = .000100/(0.0025) MIN TIN/LEAD (90/10) OVER .000050/(0.0013) NICKEL PLATE.
  - 640 = .000015/(0.00038) MIN GOLD IN SELECTIVE AREA; .000050/(0.0013) MIN TIN/LEAD (90/10) ON SOLDER TAILS BOTH OVER .000050/(0.0013) NICKEL PLATE.
  - 641 = .000030/(0.00076) MIN GOLD IN SELECTIVE AREA; .000050/(0.0013) MIN TIN/LEAD (90/10) ON SOLDER TAILS BOTH OVER .000050/(0.0013) NICKEL PLATE.
- PRODUCT SPECIFICATION: PS-43650
- MATES WITH MICRO FIT (3.0) RECEPTACLE SERIES 43645
- TRAY PACKAGED ; SEE MOLEX DRAWING PK-70873-0811

	FINISH 194	FINISH 640	FINISH 641
CKTS	MATERIAL NO:	MATERIAL NO:	MATERIAL NO:
02	43650-0227	43650-0228	43650-0229
03	43650-0327	43650-0328	43650-0329
04	43650-0427	43650-0428	43650-0429
05	43650-0527	43650-0528	43650-0529
06	43650-0627	43650-0628	43650-0629
07	43650-0727	43650-0728	43650-0729
08	43650-0827	43650-0828	43650-0829
09	43650-0927	43650-0928	43650-0929
10	43650-1027	43650-1028	43650-1029
11	43650-1127	43650-1128	43650-1129
12	43650-1227	43650-1228	43650-1229

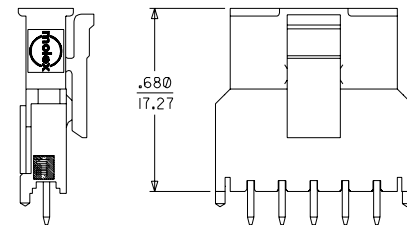

MATED MICRO FIT CONNECTORS

REVISED FINISH EC NO. UCR2001-0898 DRW: BURLERSON 01/05/02 CHK: MUELLER 01/05/02 APPR: EDGLEY 01/05/02	QUALITY SYMBOLS MAJOR CRITICAL	GENERAL TOLERANCES: (UNLESS SPECIFIED) 4 PLACES ±0.10 3 PLACES ±0.15 2 PLACES ±0.25 1 PLACE ±0.36		SCALE : <input checked="" type="checkbox"/> mm <input type="checkbox"/> INCH	DESIGN UNITS : <input type="checkbox"/> mm <input type="checkbox"/> INCH	THIRD ANGLE PROJECTION	DIMENSIONS: <input type="checkbox"/> mm <input checked="" type="checkbox"/> INCH <input type="checkbox"/> ONLY	SHT REVISE ON CAD ONLY	REV
		DRAWN BY & DATE SAMIEC 00/07/07	TITLE: MICRO FIT (3.0) SINGLE ROW / VERTICAL THRU HOLE / PEGS / TRAY						
		CHECKED BY & DATE MUELLER 00/07/07	APPROVED BY & DATE EDGLEY 00/07/07						
		CAD FILENAME	MATERIAL NO. SEE CHART	DRAWING NO. SD-43650-010	SHEET NO. 1 OF 1	SIZE C			

DRAFT WHERE APPLICABLE MUST REMAIN WITHIN DIMENSIONS

THIS DRAWING CONTAINS INFORMATION THAT IS PROPRIETARY TO MOLEX INCORPORATED AND SHOULD NOT BE USED WITHOUT WRITTEN PERMISSION.