



SOT-23 Plastic-Encapsulate Diodes

- **Pb-Free package is available**
RoHS product for packing code suffix "G"
Halogen free product for packing code suffix "H"
- **Moisture Sensitivity Level 1**

DEVICE MARKING AND ORDERING INFORMATION

Device	Marking	Package	Shipping
BAS16LT1	A6	SOT-23	3000/Tape&Reel

MAXIMUM RATINGS

Rating	Symbol	Value	Unit
Continuous Reverse Voltage	V_R	75	Vdc
Peak Forward Current	I_F	200	mAdc
Peak Forward Surge Current	$I_{FM(surge)}$	500	mAdc

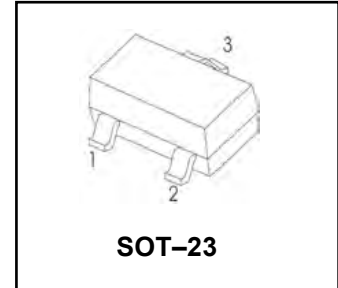

THERMAL CHARACTERISTICS

Characteristic	Symbol	Max	Unit
Total Device Dissipation FR-5 Board, (1) $T_A = 25^\circ\text{C}$	P_D	225	mW
Derate above 25°C		1.8	mW/ $^\circ\text{C}$
Thermal Resistance, Junction to Ambient	$R_{\theta JA}$	556	$^\circ\text{C}/\text{W}$
Total Device Dissipation Alumina Substrate, (2) $T_A = 25^\circ\text{C}$	P_D	300	mW
Derate above 25°C		2.4	mW/ $^\circ\text{C}$
Thermal Resistance, Junction to Ambient	$R_{\theta JA}$	417	$^\circ\text{C}/\text{W}$
Junction and Storage Temperature	T_J, T_{stg}	-55 to +150	$^\circ\text{C}$

ELECTRICAL CHARACTERISTICS ($T_A = 25^\circ\text{C}$ unless otherwise noted)

Characteristic	Symbol	Min	Max	Unit
----------------	--------	-----	-----	------

OFF CHARACTERISTICS

Reverse Voltage Leakage Current ($V_R = 75\text{Vdc}$)	I_R	—	1.0	μAdc
($V_R = 75\text{Vdc}, T_J = 150^\circ\text{C}$)		—	50	
($V_R = 25\text{Vdc}, T_J = 150^\circ\text{C}$)		—	30	
Reverse Breakdown Voltage ($I_{BR} = 100\ \mu\text{Adc}$)	$V_{(BR)}$	75	—	Vdc
Forward Voltage ($I_F = 1.0\ \text{mAdc}$)	V_F	—	715	mV
($I_F = 10\ \text{mAdc}$)		—	855	
($I_F = 50\ \text{mAdc}$)		—	1000	
($I_F = 150\ \text{mAdc}$)		—	1250	
Diode Capacitance ($V_R = 0, f = 1.0\ \text{MHz}$)	C_D	—	2.0	pF
Forward Recovery Voltage ($I_F = 10\ \text{mAdc}, t_r = 20\text{ns}$)	V_{FR}	—	1.75	Vdc
Reverse Recovery Time ($I_F = I_R = 10\ \text{mAdc}, R_L = 50\ \Omega$)	t_{rr}	—	6.0	ns
Stored Charge ($I_F = 10\ \text{mAdc}$ to $V_R = 5.0\text{Vdc}, R_L = 500\ \Omega$)	Q_S	—	45	pC

1. FR-5 = 1.0 x 0.75 x 0.062 in.

2. Alumina = 0.4 x 0.3 x 0.024 in. 99.5% alumina.

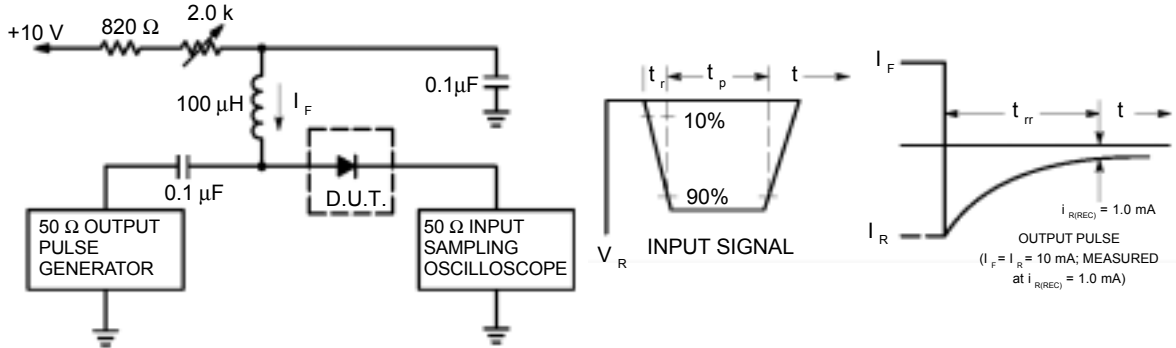

- Notes: 1. A 2.0 kΩ variable resistor adjusted for a Forward Current (I_F) of 10 mA.
- 2. Input pulse is adjusted so $I_{R(peak)}$ is equal to 10 mA.
- 3. $t_p \gg t_{rr}$

Figure 1. Recovery Time Equivalent Test Circuit

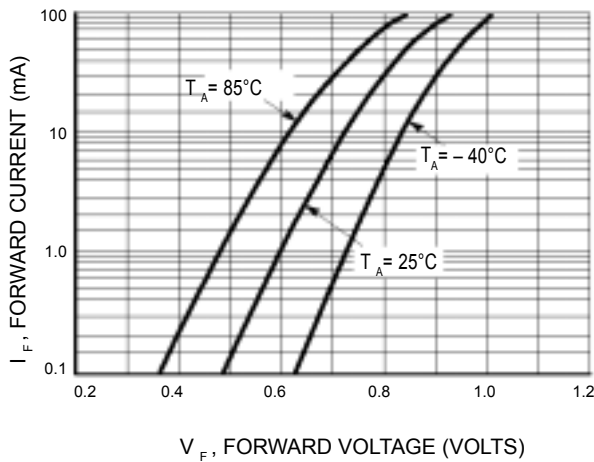

Figure 2. Forward Voltage

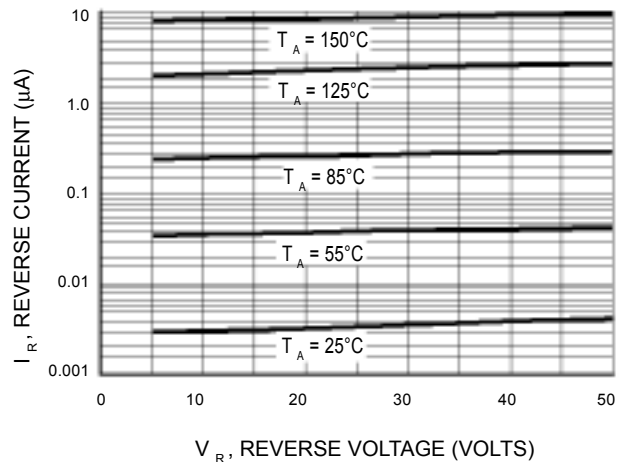

Figure 3. Leakage Current

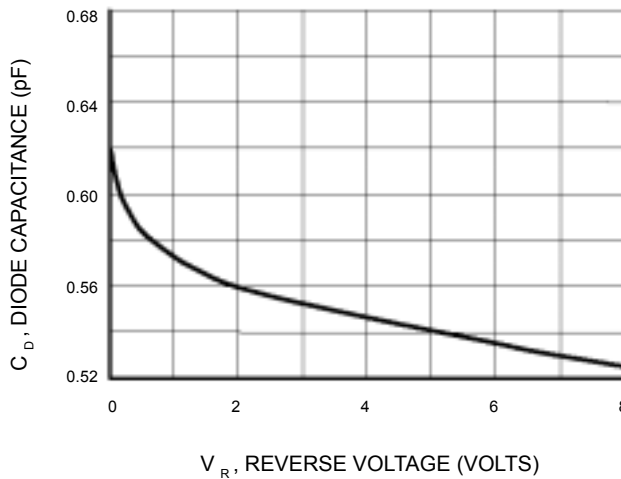

Figure 4. Capacitance



WILLAS



SOT-23 Plastic-Encapsulate Diodes

BAS16LT1

SOT-23

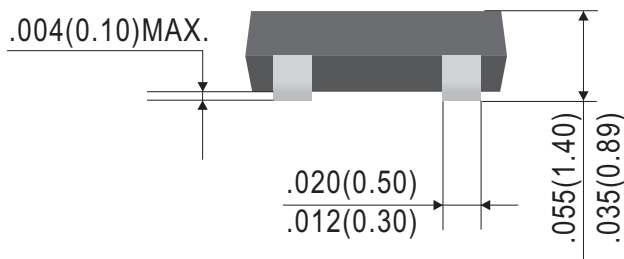
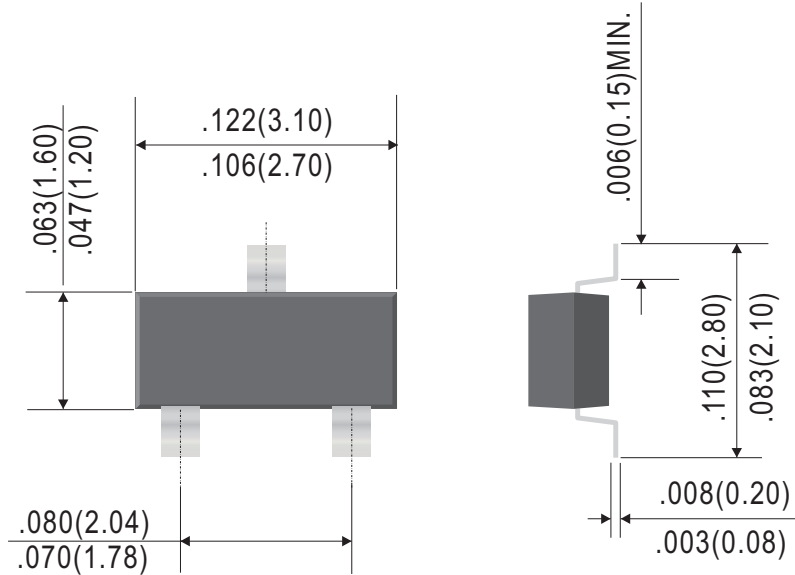

Dimensions in inches and (millimeters)

