

FEATURES

- ◆ RoHS compliant
- ◆ Efficiency up to 80%
- ◆ Power density up to 0.42W/cm³
- ◆ Wide temperature performance at full 1 Watt load, -40°C to 85 °C
- ◆ Single and dual output
- ◆ UV 94V-0 package material
- ◆ No heatsink required
- ◆ 3.3V,5V,12V input
- ◆ Industry standard pinout
- ◆ Footprint 1.91cm²
- ◆ 6KVDC isolation
- ◆ 3.3V,5V,9V,12V and 15V output
- ◆ Internal SMD construction
- ◆ Fully encapsulated with toroidal Magnetics
- ◆ No external components required
- ◆ MTTF up to 13 million hours
- ◆ No electrolytic or tantalum capacitors
- ◆ Custom solutions available

MODEL SELECTION

H^①05^②05^③X^④S^⑤-1W^⑥

- ① Product Series
- ② Input Voltage
- ③ Output Voltage
- ④ Fixed Input
- ⑤ SIP Package
- ⑥ Rated Power

APPLICATIONS

The H_XS-1W&G_XS-1W series are dual and single output DC/DC converters in a 7 pin SIP package style offering pin and functionality compatibility with the E series SIP DC/DC converters.

The H_XS-1W&G_XS-1W series is UI60950 recognized and suitable for applications where safety and miniaturisation are of paramount importance. Isolation barrier approved for supplementary/reinforced insulation.



SELECTION GUIDE

Order code	Input Voltage (V)	Output Voltage (V)	Output Current (MA)	Ripple&Noise ² (MA)	Efficiency (%)	Isolation Capacitance (PF)	MTTF ¹ (KHRS)
G0505XS-1W	5	±5	±100	40	60	3.0	4950
G0509XS-1W	5	±9	±55	30	65	3.0	3832
G0512XS-1W	5	±12	±42	20	65	3.0	2770
G0515XS-1W	5	±15	±33	20	65	3.0	1903
G1205XS-1W	12	±5	±100	40	60	3.0	3688
G1209XS-1W	12	±9	±55	30	65	3.0	3029
G1212XS-1W	12	±12	±42	20	65	3.0	2324
G1215XS-1W	12	±15	±33	20	65	3.0	1682
H0303XS-1W	3.3	3.3	303	70	66	3.0	13780
H0503XS-1W	5	3.3	303	60	64	3.0	13460
H0505XS-1W	5	5	200	50	68	3.0	13360
H0509XS-1W	5	9	111	50	72	3.0	12700
H0512XS-1W	5	12	83	50	71	3.0	11490
H0515XS-1W	5	15	66	50	71	3.0	9980
H1205XS-1W	12	5	200	50	69	3.0	8447
H1209XS-1W	12	9	111	50	73	3.0	8176
H1212XS-1W	12	12	83	50	73	3.0	7660
H1215XS-1W	12	15	66	50	74	3.0	6950

INPUT CHARACTERISTICS

Parameter	Conditions	Min.	Typ.	Max	Units
Voltage range	Continuous operation,3V input types	2.97	3.3	3.63	V
	Continuous operation,5V input types	4.5	5	5.5	
	Continuous operation,12V input types	10.8	12	13.2	

ABSOLUTE MAXIMUM RATINGS

Short-circuit protection ³	1 second
Lead temperature 1.5mm from case for 10 seconds	300° C
Input voltage VIN,H/G03 types	5V
Input voltage VIN,H/G05 types	7V
Input voltage VIN,H/G12 types	15V

1.Calculated using MIL-HDBK-217FN2 calculation model with nominal input voltage at full load.

2.See ripple & noise test method.

3.Supply voltage must be disconnected at the end of the short circuit duration.

All specifications typical at TA=25°C,nominal input voltage and rated output current unless otherwise specified.

OUTPUT CHARACTERISTICS

Parameter	Conditions	Min.	Typ.	Max.	Units	
Rated Power ¹	TA=-40° C to 60° C			1	W	
Voltage Set Point	See tolerance envelope					
Line regulation	High Vin to low Vin		1.0	1.2	%%	
Load regulation	10% load to rated load,xx03		10.0	15.0	%	
	10% load to rated load,0505		7.0	10.0		
	Single outputs	10% load to rated load,0509,0512,0515		6.0		10.0
		10% load to rated load,12xx		5.0		7.0
Load regulation	10% load to rated load,5V output types		10.0	15.0	%	
	10% load to rated load,9V output types		6.0	10.0		
	Dual outputs	10% load to rated load,12V output types		6.0		10.0
		10% load to rated load,15V output types		6.0		10.0
Zero Load Power	All types		250		MW	

ISOLATION CHARACTERISTICS

Parameter	Conditions	Min.	Typ.	Max.	Units
Isolation test voltage	Flash tested for 1 second	5200			VDC
Resistance	Viso=500VDC		1		GΩ

GENERAL CHARACTERISTICS

Parameter	Conditions	Min.	Typ.	Max.	Units
Switching frequency	Single output		45		kHz
	Dual output		70		

TEMPERATURE CHARACTERISTICS

Parameter	Conditions	Min.	Typ.	Max.	Units
Specification	All output types	-40		60	° C
Storage		-55		130	
Case Temperature above	All output types			33	

TEMPERATURE DERATING GRAPH

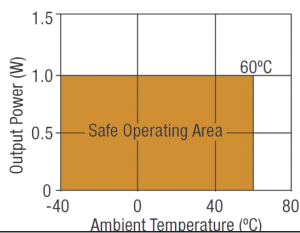

1. See derating graph.

All specifications typical at TA=25° C, nominal input voltage and rated output current unless otherwise specified. Another 24V & 48V products, please inquire Our technical department!

TOLERANCE ENVELOPE

H-XS/G-XS-1W

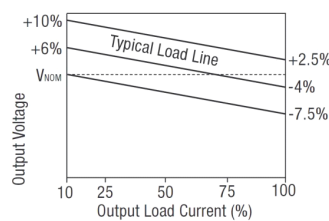

3.3V in, 3V out type only

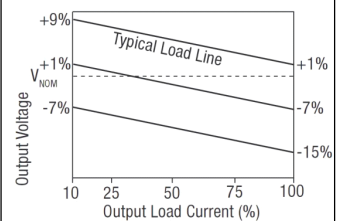

TECHNICAL NOTES

ISOLATION VOLTAGE

"Hi Pot Test", "Flash Tested", "Withstand Voltage", "Proof Voltage", "Dielectric Withstand Voltage" & "Isolation Test Voltage" are all terms that relate to the same thing, a test voltage. Applied for a specified time, across a component designed to provide electrical isolation, to verify the integrity of that isolation. Professional Power Module H_S-1W&G_S-1W series of DC/DC converters are all 100% production tested at their stated isolation voltage. This is 6KVDC for 1 second.

A question commonly asked is, "What is the continuous voltage that can be applied across the part in normal operation?"

The H_S-1W&G_S-1W series has been recognized by Underwriters Laboratory to 300Vrms for Supplementary Insulation and 150Vrms for Reinforced Insulation.

REPEATED HIGH-VOLTAGE ISOLATION TESTING

It is well known that repeated high-voltage isolation testing of a barrier component can actually degrade isolation capability, to a lesser or greater degree depending on materials. Construction and environment. We therefore strongly advise against repeated high voltage isolation testing, but if it is absolutely required, that the voltage be reduced by 20% from specified test voltage.

OUTPUT RIPPLE REDUCTION

By using the values of inductance and capacitance stated, the output ripple at the rated load is lowered to 5mV p-p max.

Component selection

Capacitor: Ceramic chip capacitors are recommended. It is required that the ESR (Equivalent Series Resistance) should be as low as possible. X7R types are recommended. The voltage rating should be at least twice (except for 15V output), the rated output voltage of the DC/DC converter.

Inductor: The rated current of the inductor should not be less than of the output of the DC/DC converter. At the rated current, the DC resistance of the inductor should be such that the voltage drop across the inductor is <2% of the rated voltage of the DC/DC converter. The SRF (Self Resonant Frequency) should be >20MHz.

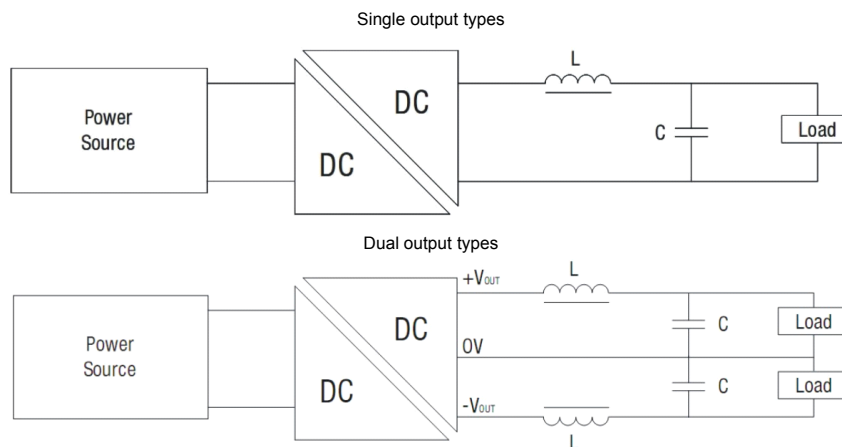

OUTPUT RIPPLE REDUCTION

Ripple & Noise Characterisation Method

Ripple and noise measurements are performed with the following test configuration.

C1	1uF X7R multilayer ceramic capacitor, voltage rating to be a minimum of 3 times the output voltage of the DC/DC converter
C2	10uF tantalum capacitor, voltage rating to be a minimum of 1.5 times the output voltage of the DC/DC converter
C3	100nF multilayer ceramic capacitor, general purpose
R1	450 Ω resistor, carbon film, ±1% tolerance
R2	50 Ω BNC termination
T1	3T of the coax cable through a ferrite toroid
RLOAD	Resistive load to the maximum power rating of the DC/DC converter. Connections should be made via twisted wires
R3	50 Ω resistor, carbon film, ±1%

Measured values are multiplied by 10 to obtain the specified values.

Differential Mode Noise Test Schematic

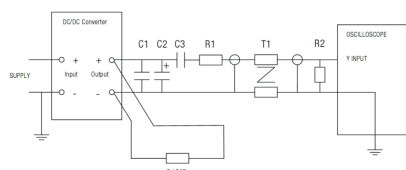

PACKAGE SPECIFICATIONS

MECHANICAL DIMENSIONS

SIP package

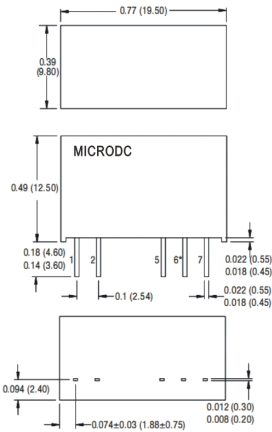

*Pin not fitted on single output variants.
 All dimensions in inches ±0.01(mm±0.25mm). All pins on a 0.1(2.54) pitch and within ±0.01(0.25) of true position. Weight: 4.3g

PIN CONNECTIONS

SINGLE OUTPUT

DUAL OUTPUT

PIN CONNECTIONS-7 PIN SIP	
pin	Function
1	+VIN
2	-VIN
5	-VOUT
7	+VOUT

PIN CONNECTIONS-7 PIN SIP	
pin	Function
1	+VIN
2	-VIN
5	-VOUT
6	0V
7	+VOUT

RECOMMENDED FOOTPRINT DETAILS

7 Pin SIP Package

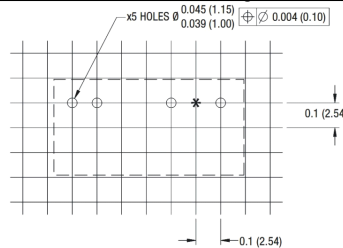

*Hole not required for single output variants.
 Unless otherwise stated all dimensions in inches ±0.01(mm ±0.25mm).

TUBE OUTLINE DIMENSIONS

7 Pin SIP Tube

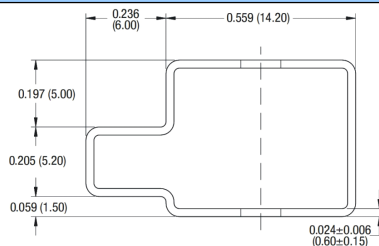

Unless otherwise stated all dimensions in inches ±0.02(mm ±0.5mm).
 Tube length(7 Pin SIP):20.669(525mm±2mm).

Tube Quantity:25

MICRODC

Professional Power Module

Microdc Professional Power Module, Inc.
 Tel:0086-20-86000646 E-mail:tech@microdc.cn
 Website:http://www.microdc.cn

Microdc Professional Power module, Inc. makes no representation that the use of its products in the circuits described herein, or the use of other technical information contained herein, will not infringe upon existing or future patent rights. Specifications are subject to change without notice.
 © 2010 Microdc Professional Power Module, Inc. Guangzhou



RoHS COMPLIANT INFORMATION

This series is compatible with RoHS soldering systems with a peak wave solder temperature of 300°C for 10 seconds. The pin termination finish on the SIP package type is Tin Plate, Hot Dipped over Matte Tin with Nickel Preplate. The DIP types are Matte Tin over Nickel Preplate. Both types in this series are backward compatible with Sn/Pb soldering systems.

REACH COMPLIANT INFORMATION

This series has proven that this product does not contain harmful chemicals, it also has harmful chemical substances through the registration, inspection and approval.