

Molex's Mizu-P25™ miniature wire-to-wire connectors provide the smallest size and highest level of dustproof and waterproof protection of any similar system in the market today. The system is IP67 rated, which ensures connector integrity when submerged in up to one meter of water.

Ideal for applications such as motorcycles or air conditioners that continue to pack more complicated electronics into smaller spaces, the Mizu-P25™ system provides assurance that dust or water will not interfere with signal integrity.

The Mizu-P25™ family includes two sub-families: the 52213/52266 type, which is rated up to 125 volts; and the 52116/52117 type, rated up to 250 volts. Both systems offer features such as integral sealing and secure positive locks. In addition, both versions provide some of the smallest mated diameters of any similar system.

**Mizu-P25™
2.50mm (.098") Pitch
Miniature Waterproof
Connector Systems**

50147/50148

52266/52213 125 Volts Type

50038/50039

52116/52117 250 Volts Type

FEATURES AND BENEFITS

50147/50148/52266/52213 Series

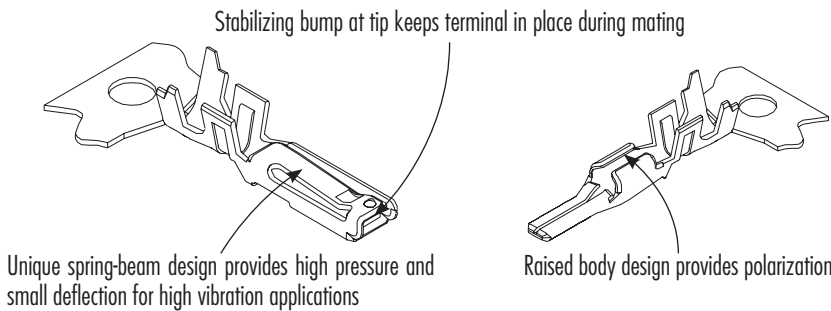

Low Voltage Type

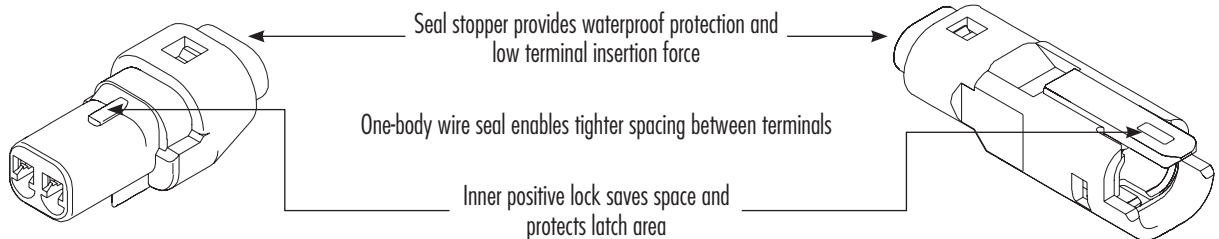

50038/50039/52116/52117 Series

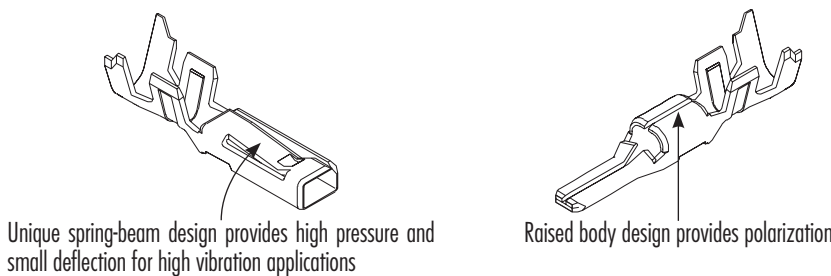

High Voltage Type

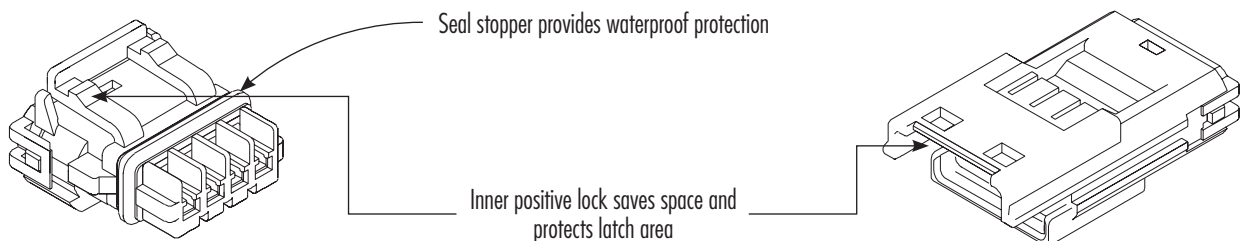

SPECIFICATIONS



Electrical

- Contact Resistance: 10 milliohms max.
- Dielectric Withstanding Voltage: 500V AC/1 min.
- Insulation Resistance: 250 Megohms min.

Physical

- Operating Temperature: -40 to +105 °C

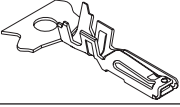
Mizu-P25™ (125 Volts type) Crimp Terminals

Image	Type	Part Number	Packaging	Voltage	Current	Wire Range	Insulation Range	Strip Length	Material	Plating	Application Tooling
	Female	50148-8000	Reel	125 Volts max.	3.0A	AVSS/CAVS 0.30 sq. (22 AWG)	1.40 ~ 1.70mm	2.00 ~ 2.50mm	Phosphor Bronze	Tin	See molex.com
		50148-8100	Bag								
	Male	50147-8000	Reel		4.0A	AVSS/CAVS 0.50 sq. (20 AWG)					
		50147-8100	Bag								

Crimp Housings

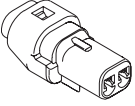
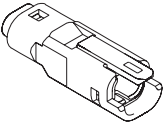
Image	Type	Part Number	Circuit Size	Voltage	Current	Housing Material	Housing Color	Packaging
	Receptacle	52213-0211	2	125 Volts max.	4.0 max.	Glass-filled PBT	Black	Tray
		52213-0311	3				Black	
		52213-0417	4				Brown	
	Plug	52266-0211	2				Black	
		52266-0311	3				Black	
		52266-0417	4				Brown	

Note: Cap-fitting tool needed for final assembly of housing. Contact Molex for details.

Mizu-P25™ (250 Volts type) Crimp Terminals

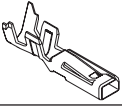
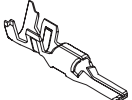
Image	Type	Part Number	Packaging	Voltage	Current	Wire Range	Insulation Range	Strip Length	Material	Plating	Application Tooling
	Female	50039-8000	Reel	250 Volts max.	3.0A	AVSS 0.30 sq. (20-22 AWG)	1.80 ~ 1.90mm	2.00 ~ 2.50mm	Phosphor Bronze	Tin	See molex.com
		50039-8100	Bag								
	Male	50038-8000	Reel								
		50038-8100	Bag								

Crimp Housings

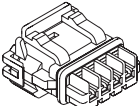
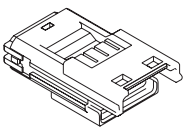
Image	Type	Part Number	Circuit Size	Voltage	Current	Housing Material	Housing Color	Packaging
	Receptacle	52117-024x	2	250 Volts max.	3.0 max.	Glass-filled PBT	Black	Tray
		52117-034x	3					
		52117-041x	4					
	Plug	52116-024x	2					
		52116-034x	3					
		52116-044x	4					

*Note: Replace x with: 0 = White color, 1 = Black color, 2 = Red color (red is available in 2 and 3 circuits only). [†]These series have versions (-0243 and -0413) which accept thinner and lighter AVSS 0.3 square wire. [‡]Cap-fitting tool needed for final assembly of housing. Contact Molex for details.

How the Mizu-P25™ System Works
(52116/52117 Type Shown Below)

Plug:

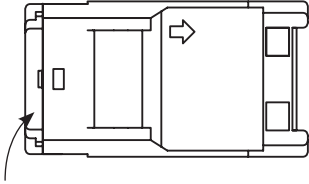

Unlocked Cap

1

Make sure connector cap is in unlocked position

Receptacle:

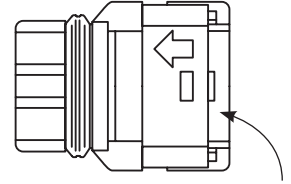

Unlocked Cap

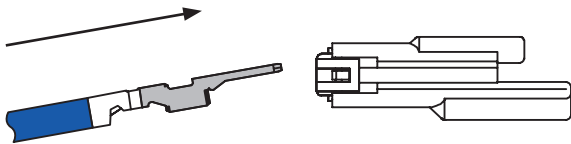

2

Insert crimped terminal into wire-end rubber seal hole and push the terminal in until you hear it click

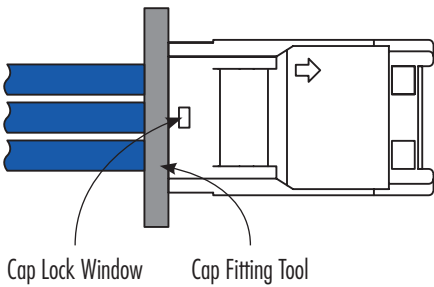
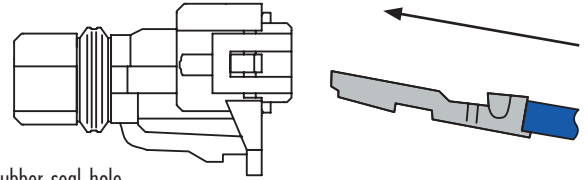

3

Tug on the wire to confirm proper insertion of the terminal. Use "Cap Fitting Tool" to seat the cap into the plug and receptacle
Check and confirm that you can see more than half of cap lock through cap lock window

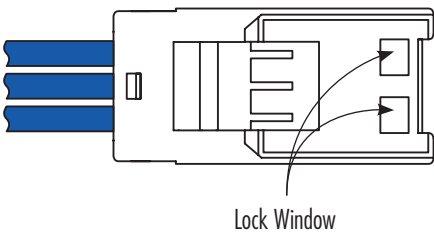
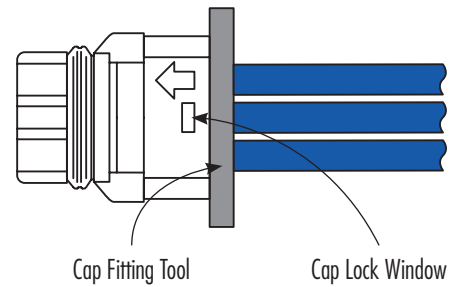

4

Match direction of lock and insert until the lock snaps in place

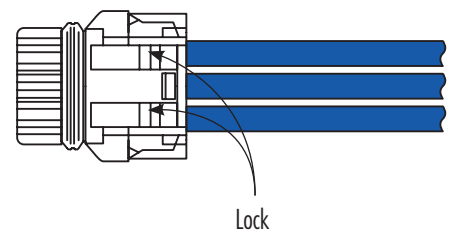

Note: Cap-fitting tool needed for final assembly of housing. Contact Molex for details.

MARKETS AND APPLICATIONS

- Mirror harness
- Lamp harness
- Air conditioning system
- Powered rear view mirrors
- LED street lights
- Vending machines
- Heated toilet seat



Mizu-P25™ 2.50mm (.098") Pitch Miniature Waterproof Connector Systems

50147/50148

52266/52213 125 Volts Type

50038/50039

52116/52117 250 Volts Type

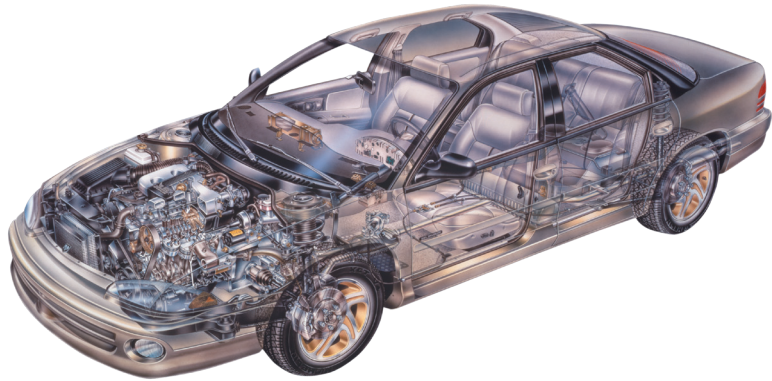

DIMENSIONAL COMPARISON

52117/52116 Series – 2 and 3 circuits

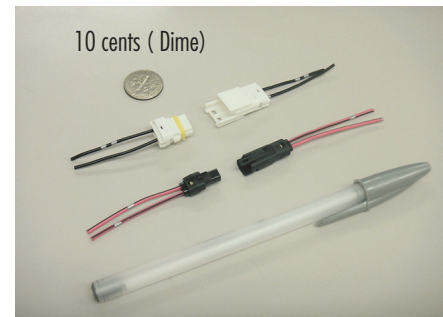
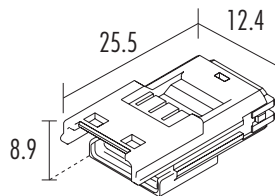
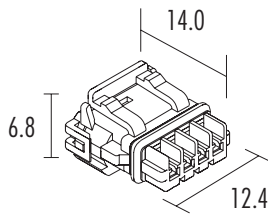

52213/52266 Series – 2 circuits

