

Users Manual

CAL 9500P Programmable Process Controller

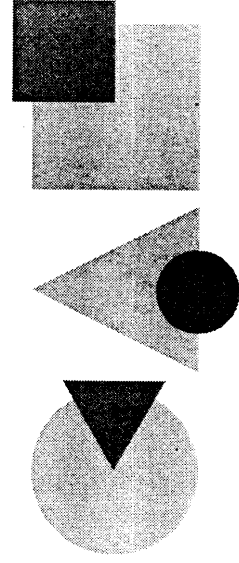

CAL Controls

INDEX

INSTRUMENT PANEL FEATURES	2
FUNCTIONS MENU	3
GETTING STARTED	4
Initial Set-up	4
AUTOTUNE	4
Tune or tune at setpoint program	5
PROPORTIONAL CYCLE-TIME	5
Cycle-time recommendations	5
SECOND AND THIRD SETPOINTS (SP2 and SP3)	5
Error messages	6
LINEAR INPUT	6
Set-up procedure	6
FUNCTION LIST	7
Level 1	7
Level 2	7
Level 3	7
Output Options Table	8
Re-transmission	8
Level 4	8
Level A	10
PROGRAMMER	11
Function overview	11
Getting started (Programmer)	12
Program run mode	12
Display functions	12
Example program	13
Function map	14
Function list	16
Memory allocation table	17
Memory full indicator	17
Programming example	18
Program edit example	18
MECHANICAL INSTALLATION	19
DIN panel cut-out	19
Mounting	19
Cleaning	19
ELECTRICAL INSTALLATION	19
Typical application	20
Input options (diagrams)	21
Output options (diagrams)	21
INPUT SENSOR SELECTION	22
Temperature sensors	22
Linear input	22
SPECIFICATION	22
SAFETY AND WARRANTY	23

INSTRUMENT PANEL FEATURES

 This page can be photocopied and used as a visual aid and bookmark when working in other parts of the manual.

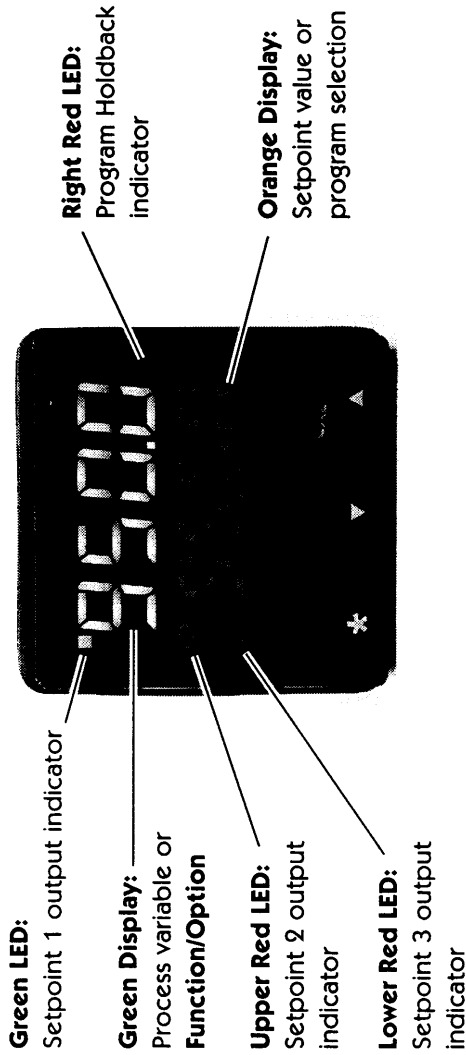

ADJUSTMENTS

- To enter or exit **program mode:** Press ▲ ▼ together for 3 seconds
- To scroll through **functions:** Press ▲ or ▼
- To change **levels or options:** Press * ▲ together or * ▼ together
- To view setpoint units: Press *
- To increase setpoint: Press * ▲ together
- To decrease setpoint: Press * ▼ together
- To reset latched alarm or tune fail: Press ▲ ▼ together briefly
- To run or Hold a program: Press * ▼ together for 3 seconds

Notes:

- If in difficulty by becoming "lost" in program mode, press ▲ and ▼ together for 3 seconds to return to display mode, check the INSTRUMENT ADJUSTMENTS above and try again.
- When in program mode, after 60 seconds of key inactivity the display will revert to either *inPt : none* or, if the initial configuration has been completed, the measured value. Any settings already completed will be retained. During Program Configuration it is recommended that this feature is inhibited. Select *Prog Stay* in Level 4.

FUNCTIONS MENU

This page can be photocopied and used as a visual aid and bookmark when working in other parts of the manual.

LEVEL 4

USER PROTECTED SETTINGS

Denote sensitivity: 0.1 to 1.0, deci (0.5) Denote AC alarm: display on Disable AC alarm: 1 to 32 () Disable program auto-ack: name, let 3, lev 4, all Security lock: name, let 3, lev 4, all Charge program entry point: Off, on

LEVEL 4 **DES** **d** **.55** **NOAL** **PROG** **LOC** **SEEL**

LEVEL 3

CONFIGURE OUTPUT

SP1 output device: name, iv, ssp, nlg SP2 output device: name, iv, ssp, nlg SP3 output device: name, iv, ssp, nlg SP4 output device: name, iv, ssp, nlg

SAFETY SETTINGS

Reverse outputs: 1, 2, 3, 4, 5, 6, 7, 8, 9, 10, 11, 12, 13, 14, 15, 16, 17, 18, 19, 20, 21, 22, 23, 24, 25, 26, 27, 28, 29, 30, 31, 32 Reverse output %: 100 to 0% Limit SP1 output %: 100 to 0% Limit SP2 output %: 100 to 0% Limit SP3 output %: 100 to 0% Limit SP4 output %: 100 to 0%

CALIBRATION

Span adjustment: 0.0 to 95.8% sensor Zero adjustment: 0.0 to 95.8% sensor Millivolt: Off, on Set monitor: Off, on

PERFORMANCE DATA

Read monitor: Xk, Yk, M, to des Read line data: C1, C2, C3, C4, C5, US, G52, C4, C5, C6, C7, C8, C9, C10, C11, C12, C13, C14, C15, C16, C17, C18, C19, C20, C21, C22, C23, C24, C25, C26, C27, C28, C29, C30, C31, C32, C33, C34, C35, C36, C37, C38, C39, C40, C41, C42, C43, C44, C45, C46, C47, C48, C49, C50, C51, C52, C53, C54, C55, C56, C57, C58, C59, C60, C61, C62, C63, C64, C65, C66, C67, C68, C69, C70, C71, C72, C73, C74, C75, C76, C77, C78, C79, C80, C81, C82, C83, C84, C85, C86, C87, C88, C89, C90, C91, C92, C93, C94, C95, C96, C97, C98, C99, C100, C101, C102, C103, C104, C105, C106, C107, C108, C109, C110, C111, C112, C113, C114, C115, C116, C117, C118, C119, C120, C121, C122, C123, C124, C125, C126, C127, C128, C129, C130, C131, C132, C133, C134, C135, C136, C137, C138, C139, C140, C141, C142, C143, C144, C145, C146, C147, C148, C149, C150, C151, C152, C153, C154, C155, C156, C157, C158, C159, C160, C161, C162, C163, C164, C165, C166, C167, C168, C169, C170, C171, C172, C173, C174, C175, C176, C177, C178, C179, C180, C181, C182, C183, C184, C185, C186, C187, C188, C189, C190, C191, C192, C193, C194, C195, C196, C197, C198, C199, C200, C201, C202, C203, C204, C205, C206, C207, C208, C209, C210, C211, C212, C213, C214, C215, C216, C217, C218, C219, C220, C221, C222, C223, C224, C225, C226, C227, C228, C229, C230, C231, C232, C233, C234, C235, C236, C237, C238, C239, C240, C241, C242, C243, C244, C245, C246, C247, C248, C249, C250, C251, C252, C253, C254, C255, C256, C257, C258, C259, C260, C261, C262, C263, C264, C265, C266, C267, C268, C269, C270, C271, C272, C273, C274, C275, C276, C277, C278, C279, C280, C281, C282, C283, C284, C285, C286, C287, C288, C289, C290, C291, C292, C293, C294, C295, C296, C297, C298, C299, C300, C301, C302, C303, C304, C305, C306, C307, C308, C309, C310, C311, C312, C313, C314, C315, C316, C317, C318, C319, C320, C321, C322, C323, C324, C325, C326, C327, C328, C329, C330, C331, C332, C333, C334, C335, C336, C337, C338, C339, C340, C341, C342, C343, C344, C345, C346, C347, C348, C349, C350, C351, C352, C353, C354, C355, C356, C357, C358, C359, C360, C361, C362, C363, C364, C365, C366, C367, C368, C369, C370, C371, C372, C373, C374, C375, C376, C377, C378, C379, C380, C381, C382, C383, C384, C385, C386, C387, C388, C389, C390, C391, C392, C393, C394, C395, C396, C397, C398, C399, C400, C401, C402, C403, C404, C405, C406, C407, C408, C409, C410, C411, C412, C413, C414, C415, C416, C417, C418, C419, C420, C421, C422, C423, C424, C425, C426, C427, C428, C429, C430, C431, C432, C433, C434, C435, C436, C437, C438, C439, C440, C441, C442, C443, C444, C445, C446, C447, C448, C449, C450, C451, C452, C453, C454, C455, C456, C457, C458, C459, C460, C461, C462, C463, C464, C465, C466, C467, C468, C469, C470, C471, C472, C473, C474, C475, C476, C477, C478, C479, C480, C481, C482, C483, C484, C485, C486, C487, C488, C489, C490, C491, C492, C493, C494, C495, C496, C497, C498, C499, C500, C501, C502, C503, C504, C505, C506, C507, C508, C509, C510, C511, C512, C513, C514, C515, C516, C517, C518, C519, C520, C521, C522, C523, C524, C525, C526, C527, C528, C529, C530, C531, C532, C533, C534, C535, C536, C537, C538, C539, C540, C541, C542, C543, C544, C545, C546, C547, C548, C549, C550, C551, C552, C553, C554, C555, C556, C557, C558, C559, C560, C561, C562, C563, C564, C565, C566, C567, C568, C569, C570, C571, C572, C573, C574, C575, C576, C577, C578, C579, C580, C581, C582, C583, C584, C585, C586, C587, C588, C589, C590, C591, C592, C593, C594, C595, C596, C597, C598, C599, C600, C601, C602, C603, C604, C605, C606, C607, C608, C609, C610, C611, C612, C613, C614, C615, C616, C617, C618, C619, C620, C621, C622, C623, C624, C625, C626, C627, C628, C629, C630, C631, C632, C633, C634, C635, C636, C637, C638, C639, C640, C641, C642, C643, C644, C645, C646, C647, C648, C649, C650, C651, C652, C653, C654, C655, C656, C657, C658, C659, C660, C661, C662, C663, C664, C665, C666, C667, C668, C669, C670, C671, C672, C673, C674, C675, C676, C677, C678, C679, C680, C681, C682, C683, C684, C685, C686, C687, C688, C689, C690, C691, C692, C693, C694, C695, C696, C697, C698, C699, C700, C701, C702, C703, C704, C705, C706, C707, C708, C709, C710, C711, C712, C713, C714, C715, C716, C717, C718, C719, C720, C721, C722, C723, C724, C725, C726, C727, C728, C729, C730, C731, C732, C733, C734, C735, C736, C737, C738, C739, C740, C741, C742, C743, C744, C745, C746, C747, C748, C749, C750, C751, C752, C753, C754, C755, C756, C757, C758, C759, C760, C761, C762, C763, C764, C765, C766, C767, C768, C769, C770, C771, C772, C773, C774, C775, C776, C777, C778, C779, C780, C781, C782, C783, C784, C785, C786, C787, C788, C789, C790, C791, C792, C793, C794, C795, C796, C797, C798, C799, C800, C801, C802, C803, C804, C805, C806, C807, C808, C809, C810, C811, C812, C813, C814, C815, C816, C817, C818, C819, C820, C821, C822, C823, C824, C825, C826, C827, C828, C829, C830, C831, C832, C833, C834, C835, C836, C837, C838, C839, C840, C841, C842, C843, C844, C845, C846, C847, C848, C849, C850, C851, C852, C853, C854, C855, C856, C857, C858, C859, C860, C861, C862, C863, C864, C865, C866, C867, C868, C869, C870, C871, C872, C873, C874, C875, C876, C877, C878, C879, C880, C881, C882, C883, C884, C885, C886, C887, C888, C889, C890, C891, C892, C893, C894, C895, C896, C897, C898, C899, C900, C901, C902, C903, C904, C905, C906, C907, C908, C909, C910, C911, C912, C913, C914, C915, C916, C917, C918, C919, C920, C921, C922, C923, C924, C925, C926, C927, C928, C929, C930, C931, C932, C933, C934, C935, C936, C937, C938, C939, C940, C941, C942, C943, C944, C945, C946, C947, C948, C949, C950, C951, C952, C953, C954, C955, C956, C957, C958, C959, C960, C961, C962, C963, C964, C965, C966, C967, C968, C969, C970, C971, C972, C973, C974, C975, C976, C977, C978, C979, C980, C981, C982, C983, C984, C985, C986, C987, C988, C989, C990, C991, C992, C993, C994, C995, C996, C997, C998, C999, C1000, C1001, C1002, C1003, C1004, C1005, C1006, C1007, C1008, C1009, C1010, C1011, C1012, C1013, C1014, C1015, C1016, C1017, C1018, C1019, C1020, C1021, C1022, C1023, C1024, C1025, C1026, C1027, C1028, C1029, C1030, C1031, C1032, C1033, C1034, C1035, C1036, C1037, C1038, C1039, C1040, C1041, C1042, C1043, C1044, C1045, C1046, C1047, C1048, C1049, C1050, C1051, C1052, C1053, C1054, C1055, C1056, C1057, C1058, C1059, C1060, C1061, C1062, C1063, C1064, C1065, C1066, C1067, C1068, C1069, C1070, C1071, C1072, C1073, C1074, C1075, C1076, C1077, C1078, C1079, C1080, C1081, C1082, C1083, C1084, C1085, C1086, C1087, C1088, C1089, C1090, C1091, C1092, C1093, C1094, C1095, C1096, C1097, C1098, C1099, C1100, C1101, C1102, C1103, C1104, C1105, C1106, C1107, C1108, C1109, C1110, C1111, C1112, C1113, C1114, C1115, C1116, C1117, C1118, C1119, C1120, C1121, C1122, C1123, C1124, C1125, C1126, C1127, C1128, C1129, C1130, C1131, C1132, C1133, C1134, C1135, C1136, C1137, C1138, C1139, C1140, C1141, C1142, C1143, C1144, C1145, C1146, C1147, C1148, C1149, C1150, C1151, C1152, C1153, C1154, C1155, C1156, C1157, C1158, C1159, C1160, C1161, C1162, C1163, C1164, C1165, C1166, C1167, C1168, C1169, C1170, C1171, C1172, C1173, C1174, C1175, C1176, C1177, C1178, C1179, C1180, C1181, C1182, C1183, C1184, C1185, C1186, C1187, C1188, C1189, C1190, C1191, C1192, C1193, C1194, C1195, C1196, C1197, C1198, C1199, C1200, C1201, C1202, C1203, C1204, C1205, C1206, C1207, C1208, C1209, C1210, C1211, C1212, C1213, C1214, C1215, C1216, C1217, C1218, C1219, C1220, C1221, C1222, C1223, C1224, C1225, C1226, C1227, C1228, C1229, C1230, C1231, C1232, C1233, C1234, C1235, C1236, C1237, C1238, C1239, C1240, C1241, C1242, C1243, C1244, C1245, C1246, C1247, C1248, C1249, C1250, C1251, C1252, C1253, C1254, C1255, C1256, C1257, C1258, C1259, C1260, C1261, C1262, C1263, C1264, C1265, C1266, C1267, C1268, C1269, C1270, C1271, C1272, C1273, C1274, C1275, C1276, C1277, C1278, C1279, C1280, C1281, C1282, C1283, C1284, C1285, C1286, C1287, C1288, C1289, C1290, C1291, C1292, C1293, C1294, C1295, C1296, C1297, C1298, C1299, C1300, C1301, C1302, C1303, C1304, C1305, C1306, C1307, C1308, C1309, C1310, C1311, C1312, C1313, C1314, C1315, C1316, C1317, C1318, C1319, C1320, C1321, C1322, C1323, C1324, C1325, C1326, C1327, C1328, C1329, C1330, C1331, C1332, C1333, C1334, C1335, C1336, C1337, C1338, C1339, C1340, C1341, C1342, C1343, C1344, C1345, C1346, C1347, C1348, C1349, C1350, C1351, C1352, C1353, C1354, C1355, C1356, C1357, C1358, C1359, C1360, C1361, C1362, C1363, C1364, C1365, C1366, C1367, C1368, C1369, C1370, C1371, C1372, C1373, C1374, C1375, C1376, C1377, C1378, C1379, C1380, C1381, C1382, C1383, C1384, C1385, C1386, C1387, C1388, C1389, C1390, C1391, C1392, C1393, C1394, C1395, C1396, C1397, C1398, C1399, C1400, C1401, C1402, C1403, C1404, C1405, C1406, C1407, C1408, C1409, C1410, C1411, C1412, C1413, C1414, C1415, C1416, C1417, C1418, C1419, C1420, C1421, C1422, C1423, C1424, C1425, C1426, C1427, C1428, C1429, C1430, C1431, C1432, C1433, C1434, C1435, C1436, C1437, C1438, C1439, C1440, C1441, C1442, C1443, C1444, C1445, C1446, C1447, C1448, C1449, C1450, C1451, C1452, C1453, C1454, C1455, C1456, C1457, C1458, C1459, C1460, C1461, C1462, C1463, C1464, C1465, C1466, C1467, C1468, C1469, C1470, C1471, C1472, C1473, C1474, C1475, C1476, C1477, C1478, C1479, C1480, C1481, C1482, C1483, C1484, C1485, C1486, C1487, C1488, C1489, C1490, C1491, C1492, C1493, C1494, C1495, C1496, C1497, C1498, C1499, C1500, C1501, C1502, C1503, C1504, C1505, C1506, C1507, C1508, C1509, C1510, C1511, C1512, C1513, C1514, C1515, C1516, C1517, C1518, C1519, C1520, C1521, C1522, C1523, C1524, C1525, C1526, C1527, C1528, C1529, C1530, C1531, C1532, C1533, C1534, C1535, C1536, C1537, C1538, C1539, C1540, C1541, C1542, C1543, C1544, C1545, C1546, C1547, C1548, C1549, C1550, C1551, C1552, C1553, C1554, C1555, C1556, C1557, C1558, C1559, C1560, C1561, C1562, C1563, C1564, C1565, C1566, C1567, C1568, C1569, C1570, C1571, C1572, C1573, C1574, C1575, C1576, C1577, C1578, C1579, C1580, C1581, C1582, C1583, C1584, C1585, C1586, C1587, C1588, C1589, C1590, C1591, C1592, C1593, C1594, C1595, C1596, C1597, C1598, C1599, C1600, C1601, C1602, C1603, C1604, C1605, C1606, C1607, C1608, C1609, C1610, C1611, C1612, C1613, C1614, C1615, C1616, C1617, C1618, C1619, C1620, C1621, C1622, C1623, C1624, C1625, C1626, C1627, C1628, C1629, C1630, C1631, C1632, C1633, C1634, C1635, C1636, C1637, C1638, C1639, C1640, C1641, C1642, C1643, C1644, C1645, C1646, C1647, C1648, C1649, C1650, C1651, C1652, C1653, C1654, C1655, C1656, C1657, C1658, C1659, C1660, C1661, C1662, C1663, C1664, C1665, C1666, C1667, C1668, C1669, C1670, C1671, C1672, C1673, C1674, C1675, C1676, C1677, C1678, C1679, C1680, C1681, C1682, C1683, C1684, C1685, C1686, C1687, C1688, C1689, C1690, C1691, C1692, C1693, C1694, C1695, C1696, C1697, C1698, C1699, C1700, C1701, C1702, C1703, C1704, C1705, C1706, C1707, C1708, C1709, C1710, C1711, C1712, C1713, C1714, C1715, C1716, C1717, C1718, C1719, C1720, C1721, C1722, C1723, C1724, C1725, C1726, C1727, C1728, C1729, C1730, C1731, C1732, C1733, C1734, C1735, C1736, C1737, C1738, C1739, C1740, C1741, C1742, C1743, C1744, C1745, C1746, C1747, C1748, C1749, C1750, C1751, C1752, C1753, C1754, C1755, C1756, C1757, C1758, C1759, C1760, C1761, C1762, C1763, C1764, C1765, C1766, C1767, C1768, C1769, C1770, C1771, C1772, C1773, C1774, C1775, C1776, C1777, C1778, C1779, C1780, C1781, C1782, C1783, C1784, C1785, C1786, C1787, C1788, C1789, C1790, C1791, C1792, C1793, C1794, C1795, C1796, C1797, C1798, C1799, C1800, C1801, C1802, C1803, C1804, C1805, C1806, C1807, C1808, C1809, C1810, C1811, C1812, C1813, C1814, C1815, C1816, C1817, C1818, C1819, C1820, C1821, C1822, C1823, C1824, C1825, C1826, C1827, C1828, C1829, C1830, C1831, C1832, C1833, C1834, C1835, C1836, C1837, C1838, C1839, C1840, C1841, C1842, C1843, C1844, C1845, C1846, C1847, C1848, C1849, C1850, C1851, C1852, C1853, C1854, C1855, C1856, C1857, C1858, C1859, C1860, C1861, C1862, C1863, C1864, C1865, C1866, C1867, C1868, C1869, C1870, C1871, C1872, C1873, C1874, C1875, C1876, C1877, C1878, C1879, C1880, C1881, C1882, C1883, C1884, C1885, C1886, C1887, C1888, C1889, C1890, C1891, C1892, C1893, C1894, C1895, C1896, C1897, C1898, C1899, C1900, C1901, C1902, C1903, C1904, C1905, C1906, C1907, C1908, C1909, C1910, C1911, C1912, C1913, C1914, C1915, C1916, C1917, C1918, C1919, C1920, C1921, C1922, C1923, C1924, C1925, C1926, C1927, C1928, C1929, C1930, C1931, C1932, C1933, C1934, C1935, C1936, C1937, C1938, C1939, C1940, C1941, C1942, C1943, C1944, C1945, C1946, C1947, C1948, C1949, C1950, C1951, C1952, C1953, C1954, C1955, C1956, C1957, C1958, C1959, C1960, C1961, C1962, C1963, C1964, C1965, C1966, C1967, C1968, C1969, C1970, C1971, C1972, C1973, C1974, C1975, C1976, C1977, C1978, C1979, C1980, C1981, C1982, C1983, C1984, C1985, C1986, C1987, C1988, C1989, C1990, C1991, C1992, C1993, C1994, C1995, C1996, C1997, C1998, C1999, C2000, C2001, C2002, C2003, C2004, C2005, C2006, C2007, C2008, C2009, C2010, C2011, C2012, C2013, C2014, C2015, C2016, C2017, C2018, C2019, C2020, C2021, C2022, C2023, C2024, C2025, C2026, C2027, C2028, C2029, C2030, C2031, C2032, C2033, C2034, C2035, C2036, C2037, C2038, C2039, C2040, C2041, C2042, C2043, C2044, C2045, C2046, C2047, C2048, C2049, C2050, C2051, C2052, C2053, C2054, C2055, C2056, C2057, C2058, C2059, C2060, C2061, C2062, C2063, C2064, C2065, C2066, C2067, C2068, C2069, C2070, C2071, C2072, C2073, C2074, C2075, C2076, C2077, C2078, C2079, C2080, C2081, C2082, C2083, C2084, C2085, C2086, C2087, C2088, C2089, C2090, C2091, C2092, C2093, C2094, C2095, C2096, C2097, C2098, C2099, C2100, C2101, C2102, C2103, C2104, C2105, C2106, C2107, C21

GETTING STARTED

After power-up the controller requires programming with the following information:

Type of Sensor (See list of sensors p.92)

Operating unit °C °F bar PSI Ph rh SET

Allocation of Output Device to SP1/SP2 (Relay / S5d) or analogue. SP3 is always relay.

Setpoint

When the above information has been programmed into the controller it will be operational with factory PID settings.

INITIAL SET-UP

On power-up the controller will display the self test sequence followed by the initial display *InPt : none*

1 Select input sensor.

Press and hold * and use the ▲ or ▼ buttons to scroll through the sensor selection list until the correct sensor is displayed. Release the buttons. The display will now read selected sensor type e.g. *InPt : tCS* (type S thermocouple).

Press ▲ once The display will now read *unit : none*

LINEAR INPUT

When **Linear Input** is selected, the display resolution of the **setpoint** and many other functions will be changed from the setting previously made at *di.SP* in Level 2, to that set at *dECP* in Level A.

It is therefore recommended that on completion of the **Initial Set-up the Linear Input** settings in Level A be completed before moving on to configure Levels 1, 2 and 3. (see Set-up Procedure page 6).

2 Select operating unit.

Press and hold * and use the ▲ or ▼ buttons to scroll through the unit selection list until the correct unit is displayed. Release the buttons. The display will read selected unit e.g. *unit : °C*

Press ▲ once The display will now read *SP1.d : none*

3 Select SP1 (Main setpoint output device)

Analogue output

The allocation of the analogue output to SP1 automatically overrides the default **proportional cycle time** setting of 20 seconds. Where the analogue output is allocated to SP2, the default **CyC.2** setting on/off must be manually changed in Level 1 to a **time proportioning** setting to enable the analogue output to operate in **proportional control mode**.

Press and hold * and use the ▲ or ▼ buttons to select from the choices *Rly, S5d* or *AnLG* depending on the model supplied. SP2 and SP3 outputs will be automatically allocated. (See output options table on page 8).

4 To enter initial configuration into controller memory

Press and hold both ▲ and ▼ buttons for 3 seconds. The display will now read *PARK* and measured variable (e.g. ambient temperature 23°). *PARK* is displayed because a setpoint has not yet been entered.

To display setpoint units

Press and hold * The displays will now read *unit* (eg. °C) and 0

To enter setpoint

Press and hold * and use ▲ button to increase or ▼ button to decrease the reading and scroll to required setpoint value. (The digit roll-over rate increases with time).

THE CONTROLLER IS NOW OPERATIONAL WITH THE FOLLOWING FACTORY SETTINGS

Proportional band/Gain	10°C/18°F/100 units
Integral time/Reset	5 mins
Derivative time/Rate	25 secs
Proportional cycle-time	20 secs
(Typical setting for relay output)	
DAC Derivative approach control	1.5
(Average setting for minimum overshoot)	

Note: For more precise control or for non temperature applications where a **Linear input** transducer is being used, the controller may need to be tuned to the process. Please refer to the following section on AUTOTUNE.

AUTOTUNE

This is a single shot procedure to match the controller to the process. Select either **Tune** or **Tune at Setpoint** from the criteria given below.

The **Tune** program should be used for applications other than those listed under **Tune at Setpoint** below. The procedure will apply disturbances when the temperature or process reaches 75% of the setpoint value, causing overshoot which is monitored in order to adjust the **DAC** overshoot inhibit feature. Care should be taken to ensure that any overshoot is safe for the process.

The **Tune at Setpoint** program is recommended when:

- The process is already at setpoint and control is poor
- The setpoint is less than 100°C in a temperature application
- Re-tuning after a large setpoint change
- Tuning multi-zone and/or heat-cool applications.

Notes: **DAC** is not re-adjusted by **Tune** at setpoint. **Proportional Cycle Time** can be pre-selected before running the Autotune program. (see page 5).

AUTOTUNE (continued)

Hereafter in the Manual the symbol (▲▼) signifies both buttons are held pressed for 3 seconds to ENTER or EXIT Program mode.

TUNE OR TUNE AT SETPOINT PROGRAM

Enter program (▲▼) and from the display *tune* : *oFF* press and hold * and press ▲ to display *tune* : *on* or *tune* : *At.SP* Exit program mode (▲▼).

The TUNE program will now start. The display will show *tune* as the process variable climbs to setpoint.

Note: Avoid tuning while running a program as SP1 may be different from the target setpoint..

When the TUNE or TUNE AT SETPOINT program is complete the PID values are entered automatically. The process will rise to setpoint and control should be stable. If not, this may be because optimum cycle time is not automatically implemented. To set the cycle time see **PROPORTIONAL CYCLE-TIME**.

PROPORTIONAL CYCLE-TIME

The choice of cycle-time is influenced by the external switching device or load. eg. contactor, SSR, valve. A setting that is too long for the process will cause oscillation and a setting that is too short will cause unnecessary wear to an electro-mechanical switching device.

Factory set

To use the 20 sec factory set cycle-time no action is needed whether autotune is used or not.

To Manually Select AUTOTUNE Calculated CYCLE-TIME

When AUTOTUNE is completed, enter program (▲▼) and select *CYC.t* in Level 1. The display will read *CYC.t* : 20 (the factory setting).

To view the new calculated optimum value, press and hold both * and ▼ buttons until indexing stops. The calculated value will be displayed eg. A16. If acceptable, exit program (▲▼) to implement this setting.

To Pre-select Automatic Acceptance of AUTOTUNE Calculated CYCLE-TIME

Before AUTOTUNE is initiated select *CYC.t* in Level1, press and hold both * and ▼ buttons until indexing stops at A -- . Exit program (▲▼) to accept calculated value automatically.

To Manually Pre-select Preferred CYCLE-TIME

Before AUTOTUNE is initiated select *CYC.t* in Level 1, press and hold both * and ▲ or ▼ buttons until indexing stops at preferred value then exit program (▲▼) to accept.

CYCLE-TIME RECOMMENDATIONS

Output Device	Factory Setting	Recommended Minimum
Internal relays	20 seconds	10 seconds
Solid state drives	20 seconds	0.1 seconds

SECOND AND THIRD SETPOINTS (SP2 and SP3)

PRIMARY ALARM MODES

Configure SP2 output to operate as an alarm from **SP2.A** in Level 2 and set the alarm setting in **SE1.2** Level 1.

Configure SP3 alarm mode **SP3.A** and setting **SE1.3** in Level A. The alarms will be individually triggered when the process value changes according to the options listed below.

dV.hi Rises above the main setpoint by the value inserted at **SE1.2/3**.

dV.Lo Falls below the main setpoint by the value inserted at **SE1.2/3**.

BAnd Rises above or falls below the main setpoint by the value inserted at **SE1.2/3**.

FS.hi Rises above the full scale setting of **SE1.2** or **SE1.3**.

FS.Lo Falls below the full scale setting of **SE1.2** or **SE1.3**.

EoP Event Output (See **Programmer** section pages 11 to 18)

SUBSIDIARY SP2 / SP3 MODES

The following additional Subsidiary alarm functions can be added to any Primary alarm configurations using the settings found at **SP2.b** in Level 2 and **SP3.b** in Level A.

LtCh Once activated, the alarms will latch and can be manually reset when the alarm condition has been removed.

Hold This feature inhibits alarm operations on power-up and is automatically disabled once the process reaches the alarm setting.

Lt.ho Combines the effects of both **LtCh** and **hoLd** and can be applied to any Primary alarm configuration.

SECOND SETPOINT (SP2) Proportional control output

Configure in Level 1 using **CyC.2** to select proportional cycle time and **brd.2** to adjust proportioning band. For Heat/Cool operation see Operating Manual.

In on-off mode, **brd.2** adjusts SP2 hysteresis.

Alarm type	On-Off operating mode SP2 and SP3	Proportional operating mode SP2 only	Legend
Deviation	Output state 	LED state 	Output ON (Relay or SSd energised)
DU.hi			Output OFF (Relay or SSd de-energised)
DU.Lo			
BAnd			
Full scale	Output state 	LED state 	LED ON
FS.hi			
FS.Lo			
COOL Strategy	Output state 	LED state 	Temperature above setpoint

SP2 / SP3 OUTPUT AND LED STATUS IN ALARM CONDITION

SP2 / SP3 ALARM ANNUNCIATOR

If a Primary Alarm mode has been configured, when an alarm condition occurs the alarm annunciator **-AL-** will be displayed alternating with the process variable. The alarm together with the display, will be automatically reset as soon as the alarm condition has been cleared.

The annunciator may be disabled by selecting **no.AL: on**, in Level 4.

ERROR MESSAGES

SENSOR FAULT

Display flashes: **inPt: FAIL**

Indicates: sensor open or short circuit or linear input over-range.

Action: Check sensor/wiring/connectors

NON-VOLATILE MEMORY ERROR

Display flashes: **data: FAIL**

Action: De-power briefly. Replace unit if problem persists

MANUAL POWER ERROR

Display flashes: **hAnd: FAIL**

Action: SP1 set to on-off in **CYC.t**

Action: Select proportional mode

IMMEDIATE FAIL ON AUTOTUNE START

Display flashes: **tunE: FAIL**

Setpoint display 0

1. No setpoint entered.

Action: Enter setpoint

2. SP1 set to ON/OFF in **CyC.t**

Action: Select proportional mode

Note: To reset and clear error press **▲ ▼** together briefly to cancel message.

FAIL LATER DURING AUTOTUNE CYCLE

The thermal characteristics of the load exceed the Autotune algorithm limits. The failure point indicated by any display 0.0 in **tech** e.g. **Cib = 0.0**

Action: 1. Change the conditions. eg. raise setpoint

2. Try **tunE: At.SP**

3. If the error message persists, call local CAL representative for advice.

LINEAR INPUT

Set-up Procedure

The **4-20mA** input model converts current into voltage using an internal resistor which spreads the signal across the input range **10 to 50 mV**, using multiplier of 2.5. When using a transducer with an output less than 4-20mA, the **input maximum and minimum mV** values can be calculated using the same multiplier.

Models with **0 to 5V** input use an internal resistor to spread the signal across the input range **0 to 50 mV** using a divider of 100. Where a transducer provides a smaller output, the **input maximum and minimum** values can be similarly calculated.

Decide what scale **minimum and maximum** will be required, and whether the scale needs **inverting**. (See Level A; **Linear Input Scaling** for list of settings and limits, page 10).

The example below shows how a **4-20mA linear Input** should be configured.

e.g. **4-20mA = 60 to 260 units where 4mA = 60 units**

Follow **INITIAL SET-UP procedure** (also see page 4).

1. **Select input sensor** Select **inPt:Lin**

2. **Select unit** Select required unit, if not available Select **unit:SET**

3. **Select SP1 output** Select from: **Rly, SSD or AnLG**

Enter initial configuration into controller memory

DO NOT ENTER SETPOINT until **Linear Input** has been configured in **Level A**

See **functions menu page 3**
and **functions list page 10**.

Configure Linear Input Enter level **A**

(Then using example given # above)

4. **Enter scale maximum** Select **An.hi:260**

5. **Enter scale minimum** Select **An.Lo:60**

6. **Enter input maximum** Select **hi.in:50.0**

7. **Enter input minimum** Select **Lo.in:10.0**

8. **Enter display resolution** Select **dECP:0000** (WARNING – otherwise settings marked **†** may be altered)

Enter **Linear Input configuration into controller memory and enter setpoint**.

Now configure **Levels 1, 2 and 3** and if required proceed with **AUTOTUNE**.

Note: Any apparent calibration errors can be removed using the **ZERO** and **SPAN** adjustments in **Level 3**.

FUNCTION LIST (LEVELS 1 to 4 and A)

Note: A Functions Menu is shown on page 3.

LEVEL 1 **LEVEL 1**

Function Options [Factory settings] shown in brackets
SELECT AUTOTUNE (see pages 4/5)
tune [oFF] on **PARK At.SP**
 Used to switch the Autotune feature on and off, to select **PARK** or Autotune at setpoint. **PARK** temporarily turns the output(s) off. To use select **PARK** and exit program mode. To disable re-enter program at **tune** and select **oFF**.

+ SP1 OPERATING PARAMETERS

bAnd 0.1 to * C/F [10°C/18°F/100 units]
SP1 proportional band/Gain or Hysteresis
 * 100% (**Hi.Sc**) sensor maximum Proportional control eliminates the cycling of on-off control. Output power is reduced, by time proportioning action, across the proportional band.

Int.t oFF 0.1 to 60 minutes [5.0]

SP1 integral time/reset

Auto-corrects proportional control offset error

dEr.t oFF 1 - 200 seconds [25]

SP1 derivate time/rate

Suppresses overshoot and speeds response to disturbances

dAC 0.5 - 5.0 x **bAnd** [1.5]

SP1 derivative approach control dAC

Tunes warm-up characteristics, independent of normal operating conditions, by adjusting when derivative action starts during start-up (smaller **dAC** value = nearer setpoint).

CyC.t A -- on.oF 0.1 - 81 sec [20]

SP1 proportional cycle-time (see pages 9/10)

Determines the cycle rate of the output device for proportional control. Select **on.oF** for ON/OFF mode.

+ **oFSI** 0 to * °C/F/units [0]

SP1 offset/manual reset

* ±50% **bAnd**. Applicable in proportional and ON/OFF mode with integral disable. **Int.t : oFF**.

SPLK [oFF] on

Lock main setpoint

Locks the setpoint preventing unauthorised adjustment.

SP2 OPERATING PARAMETERS (see page 6)

Function Options [Factory settings] shown in brackets

+ **SEt.2** [0] to * °C/F/units

Adjust SP2 setpoint

* Deviation Alarms **DV.hi, DV.Lo, bAnd** 25% sensor maximum.

* Full scale alarms **FS.hi, FS.Lo** sensor range f/s

+ **bnd.2**

0.1 - * °C/F/units

[2.0 °C/3.6°F & units]

Adjust SP2 hysteresis or proportional band/gain
 (see **CyC.2** setting)

* 100% sensor f/s (**Hi.Sc**)

CyC.2 [on.oFF]

0.1-81 seconds

Select SP2 ON/OFF or proportional cycle-time

Select on.oFF for ON/OFF mode, or the cycle rate of SP2 output device for proportional mode.

LEVEL 2 **LEVEL 2**

MANUAL CONTROL MODES

Function Options [Factory settings] shown in brackets

SP1.P

Read SP1 output percentage power

0 to 100 % 'read only'

hAnd [oFF]

1 to 100 % (not in ON/OFF)

SP1 manual percentage power control

For manual control should a sensor fail. Record typical **SP1.P** values beforehand.

PL.1

100 to 0 % duty cycle

[100]

Set SP1 power limit percentage

Limits maximum SP1 heating power during start-up and in proportional band.

PL.2

100 to 0 % duty cycle

[100]

Set SP2 percentage power limit (cooling)

SP2 OPERATING MODES (see page 5)

SP2.A [nonE]

Main SP2 operating mode

dV.hi dV.Lo bAnd FS.hi FS.Lo Cool EoP

SP2.b [nonE]

Subsidiary SP2 mode: latch/sequence

LtCh hoLd nLin

Non-linear cool proportional band

+ Will be affected by **dECP** settings in Level A

INPUT SELECTION AND RANGING

dl.SP [1] 0.1

Select display resolution: for display of process value, setpoint, **OFSt**, **Set.2**, **hi.SC**, **LoSC**.

+ **hi.SC [sensor maximum]** sensor minimum °C/°F/units
Set full scale

+ **Lo.SC [sensor minimum]** sensor maximum °C/°F/units
Set scale minimum (default 0°C/32°F or 0 units)

inPt Select input sensor [none]
(See **SENSOR SELECTION** table, page 22)

NB. If **Linear Input** selected, start configuration from **Level A**.

unit [none] °C °F bar Psi Ph rh SET
Select required operating unit from above options

LEVEL 3 LEVEL 3

OUTPUT CONFIGURATION

Note 1: 'Read only' after initial configuration. **rSET ALL** full reset to factory settings required to change **SP1.d** subsequently.

Note 2: Depending on the Model, **SP1** and **SP2** may be fitted with any of three output types, **RLY**, **SSd** or **Analogue** (Specification on page 11/12) where appropriate, these must be allocated during initial configuration. **SP3** is always fitted with **RLY**.

Output Options Table

Model	SP1 Output	SP2 Output	SP3 Output
95111P	RLY	RLY	RLY
95001P	SSd RLY	RLY SSd	RLY RLY
95221P	SSd	SSd	RLY
*95X11P	AnLG RLY	RLY AnLG	RLY RLY
*95X21P	AnLG SSd	SSd AnLG	RLY RLY

* Substitute for X In table above, Analogue options B = 4-20mA, C = 0-5V, D = 0-10V

Re-transmission

* These models above offer the option of using the analogue output for **Re-transmission**. Select **bAnd** or **bnd.2** value in **LEVEL 1** to equal the full range setting in **LEVEL A** and if using **SP1** output, set **int.t** and **dErt.t** in **LEVEL 1** to off.

Example: Set-Up using a Model 95B11P to Re-transmit the 4-20 mA input, scaled 0 to 100 units. **SP1** relay is used as the control output and **SP2** analogue output is used for re-transmission.

Note: Read in conjunction with Linear Input Set-up Procedure on page 6.

Function **Options** [Factory settings] shown in brackets
From initial power-up:
Set **inPt none** to **inPt Lin**
unit none to **unit SET** (for example)
SP1.d none to **SP1.d RLY**

To scale the input, select **LEVEL A**, then:
Set **dECP** to **000.0** (e.g. required resolution)
An.hi to **100.0**
An.Lo to **0.0**
hi.in to **50** (ie 20mA)
Lo.in to **10** (ie 4mA)

To align **SP2** analogue re-transmission with **SP1** control output, select **LEVEL 2** then:
Set **SP2.A** to **FS.hi**

And in **LEVEL 1**
Set **SET.2** to **50** (ie 50% of display range)
bnd.2 to **100** (ie 100% of display range)

Finally, set **SP1** setpoint value as required for process to start.

Using **SP1** output for re-transmission
Set **int.t** to off
dErt to off
rev.d to **1d.2d** to invert **SP1** output
SP1 Setpoint to midscale

burr Sensor burn-out/break protection

Caution: Settings affect fall safe state.

[uPSC]	SP1	SP2
dn.SC	Upscale	Upscale
1u.2d	Downscale	Downscale
1d.2u	Upscale	Upscale
	Downscale	Downscale

+ Will be affected by **dECP** settings in Level A

LEVEL 3 CONTINUED

Function Options [Factory settings] shown in brackets

rEu.d Select output modes: Direct/Reverse
 Caution: Settings affect fail safe state.

SP1 Reverse [1r.2d]
 Direct 1d.2d
 SP2 Direct Reverse 1r.2r
 Reverse 1d.2r

Select Reverse on SP1 for heating and Direct for cooling applications.

rEu.L Select SP1/2 LED indicator modes

SP1 Normal [1n.2n]
 Invert 1i.2n
 SP2 Normal Invert 1n.2i
 Invert 1i.2i

+ **SPAN** [0.0] to ±25% sensor maximum
 Sensor span adjust
 For recalibrating to align readings with another instrument e.g. External Meter, data logger.
 See Full Operating Manual (ADVANCED SETTINGS).

+ **Zero** [0.0] to ±25% sensor f/s
 Zero sensor error (see Sensor span adjust above).

ChEK [oFF] on
 Select control accuracy monitor

+ **rEAD** [Var] hi Lo
 Read control accuracy monitor

+ **tECh** [Ct A] CT b Ct 1 Ct 2 Ct 3 Ct 4 oS 1 uS oS 2
 Read Autotune tuning cycle data (see Operating Manual)

UEr Software version number

rSET [nonE] ALL
 Resets all functions to factory settings

Caution: This selection will lose all of the current settings.

LEVEL 4 LEUL4

Access to level 4 is gained through **UEr** in level 3. Press and hold **▲** and **▼** for 10 seconds.

Enter level 4 at **Lock**, release **▲** and **▼** together. Display reads **LoCK nonE**

Program security using Lock [nonE]

Select from three **Lock** options: Press and hold *****, press **▲** to **Index**.

LEV.3 locks level 3, 4, A (and C when fitted)
LEV.2 locks level 2, 3, 4, A (and C when fitted)
ALL locks all functions (including C when fitted)

Note: Any locked functions and options can still be read.
 Press **▼** to access following functions.

Function Options [Factory settings] shown in brackets

ProG [Auto] **STAY**

Program mode auto-exit switch

Auto-exit returns display to normal if 60 seconds of key inactivity, select **STAY** to disable

no.AL [oFF] on

Disable SP2 alarm annunciator -AL-

Select on to disable -AL-

di.SS **dir** 1 to 32 [6]

Display sensitivity

dir = direct display of input 1 = maximum, 32 = minimum sensitivity

dEr.S 0.1 to 1.0 [0.5]

Derivative sensitivity

SEt.L [oFF]

on Remember next menu exit point and use as new menu entry point, except when exit is in Level 1.

LEVEL P LEULP

See PROGRAMMER Section, page 11.

LEVEL C LEULC

COMMS SETTINGS; visible only when Comms option fitted.

LEVEL A LEVEL R

[Factory settings] shown in brackets

Function	Options
brn.3 [uPSC] Sensor burn-out / break protection Select upscale or downscale	uPSC or dnSC
rEV.3 [3d] Reverse SP3 output mode Select direct or reverse operation	3d or 3r

[Factory settings] shown in brackets

Options

Linear Input Scaling

Please read in conjunction with Linear Input Set-up Procedure on page 6.

+ An.hi Adjusts required scale maximum	-1999 to 9999 [1000]
+ An.Lo Adjusts required scale minimum	-1999 to 9999 [0]
hi.in Configure input maximum	0.1 to 50.0 [50.0]
Lo.in Configure Input minimum This setting must be at least 0.1 less than the setting for hi.in above.	0.0 to 49.9 [10.0]

Note: Refer to Linear Input conversion factors detailed in the Set-up Procedure on page 6.

dECP

000.0 to 00.00 [0000]

Scale resolution

NB. Once the **Linear Input** option has been selected, the setting here over-rides the scale resolution setting **di.SP** in Level 2 and will affect the following display readings:

Level A:	An.hi; An.Lo; Set.3; hYS.3
Level 1:	bAnd; ofSt; SPrr; SEI2; bnd.2
Level 2:	hISC; LoSC
Level 3:	SPAN; ZERo; rEAd; rECh

SP3 SETTINGS

SP3.A [nonE]

Main SP3 operating mode

dV.hi dV.lo bAnd FS.hi FS.Lo EoP

SP3.b [nonE]

Subsidiary SP3 operating mode

LtCh hoLd Lt.ho

SEI.3

SP3 setpoint adjustment

0 to 2500
[0]

hYS.3

Set SP3 hysteresis

0.1 to 100% of hISC
[20]

PROGRAMMER

INDEX

Function overview	11
Getting started	12
Program run mode	12
Display functions	12
Example program	13
Function map	14
Function list	16
Memory allocation table	17
Memory full indicator	17
Programming example	18
Program edit example	18

FUNCTION OVERVIEW

The Programmer function in Level P enables the Model 9500P to control applications needing **Setpoint** changes over time. Examples of this are **Ramp** changes where a gradual **Rate** of change can be set, or **Step** changes which are instantaneous. These can be separated by **Soak** periods during which the process is held at a constant value. Each individual time interval of the program or **Segment**, together with its associated moving setpoint value can be stored as a unique **Program** and for example be represented by the diagram below.

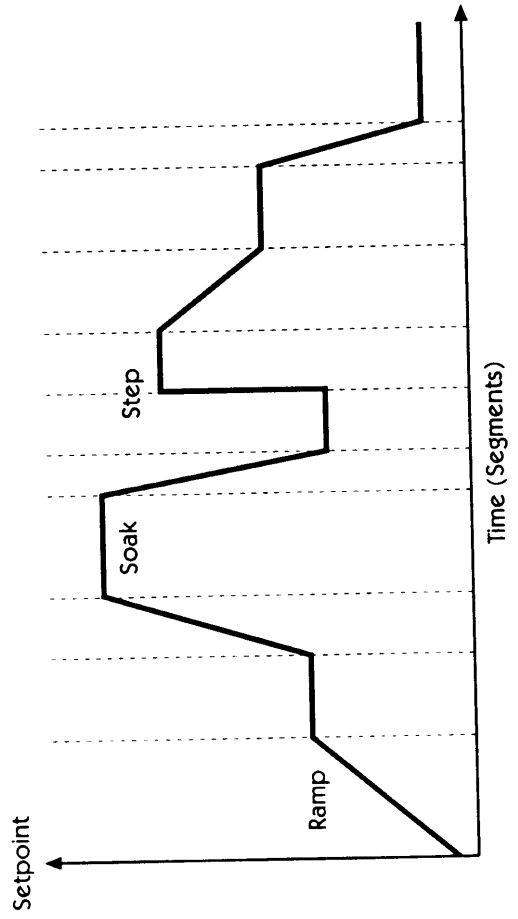

In addition to those settings that determine the segment profile, it is also necessary to set **program start** values, together with the preferred **ramp rate time units** for each individual program.

At the end of a sequence, a Program can be arranged to **repeat (Loop)**, either a specified number of **Cycles**, or continuously. Only one **Loop** can be included in a **Program**. When the program is running, the **Display** indicates progress through the sequence of segments, and can additionally be interrogated for further segment information.

To speed up **Program** configuration, several **Edit** functions have been provided so that individual **Segments** and **Programs** may be **Deleted** or **Inserted**, and an entire **Program** may be **Copied** and then **Pasted** into another that it will replace.

For safety reasons, three modes of recovery from a power failure are available. These either automatically **Re-start** the Program from the beginning, **Continue** it from where it stopped, or **Hold** it waiting for a user re-start.

Either one or both of the two auxiliary outputs can be configured as **Event outputs**.

Engaging the **Holdback** feature will temporarily halt Setpoint ramping to allow the process temperature to catch up should it deviate by more than a pre-set amount during a **Ramp** segment.

To afford maximum programming flexibility, memory is allocated dynamically, and not pre-allocated. This allows the user the freedom to configure a small number of long programs or a larger number of shorter ones, up to the permitted maximum of 126 Segments per program, and a limit of 31 Programs. Should these limits be exceeded, or the Programmer memory become fully used, the display will read **PROG FULL**. Programs can be planned using the **Memory Allocation Table** which details the memory requirements of individual segment types. During configuration a check can be kept on memory usage by interrogating the **USED** feature of the display to give an instant reading of 'percentage memory used'.

Finally, once a program has been configured, it can be run from the **run off/on/hold** controls in Level P, and in addition a quick access **run/hold** toggle is directly available from the front panel.

The **Programmer Functions List** describes the full range of available **Settings** for each **Programmer Function** together with their display mnemonic. The **Model 9500P** is supplied with a suite of **Factory Settings** for each **Function**. These are shown in bold type.

The Functions Map illustrates the relationship between the **Functions** and their **Settings** and provides a guide to the **Keying Operations** required to navigate around the menu when configuring or running a Program.

GETTING STARTED (PROGRAMMER)

For users with previous experience of configuring programmers, the **Function List** and **Functions Map** on pages 14/15 and 16/17 respectively will be reasonably self explanatory. The **Functions** and their **Settings** are grouped to maximise speed of Programming.

New users should take a short time to study the following before starting to configure the first program, and may wish to take on board the following tips and suggestions.

Program Mode Exit switch (Prog/Auto) Program Level 4.

This standard feature of the Model 9500 causes automatic exit from program mode after sixty seconds of Key inactivity. It is highly recommended that this setting be disabled and changed to **Prog/Stay** to ensure that adequate time is available for making unfamiliar adjustments. (see page 9). It may also be useful at this point to consider the setting also on Level 4, **SEIL** that enable the Programmer menu entry point to be changed from its default position to the point of last exit. (see page 9).

Program Parameter List

Listing the required **Program Settings** and **Parameter Values** segment by segment beside each **Setting/Segment Number**, and **Program Display Mnemonic** will reduce the risk of programming mistakes during the learning period.

Memorise Basic Key Functions

Use the **Function Map** on pages 14 and 15 to become familiar with the following Menu Navigation principles.

Hold both **▲** and **▼** for three seconds to enter or exit Program Mode.

Key either **▲** or **▼** to view Functions (follow horizontal arrows).

Key either ***▲** or ***▼** to view or change settings (follow vertical arrows).

Key ***** and hold for three seconds to confirm Edit Functions. †

Note: Factory Settings appear in the lower display in each of the **Functions** illustrated in the **Function Map**.

Program configuration

When the **PROGRAMMER** function is entered at **LEVEL P**, the Programmer is automatically presented in Configuration Mode, and the instrument display can be used to access and adjust the various **FUNCTIONS** as they appear in the **FUNCTIONS MAP** illustrated on pages 14 and 15.

Program Run Mode

To run a Program from **LEVEL P**,

Press **▲** once, then use ***▲** to select the required program number from the **PROG** list.

Press **▲** again once then use ***▲** to select the run/on option.

Press **▼▲** and hold for three seconds to exit configuration mode and run the program.

Run/Hold Toggle Feature

Press ***▼** and hold for 3 seconds to hold the program.

Press ***▼** again and hold for 3 seconds to run the program.

Note: Level P is 'read only' while a program is active.

DISPLAY FUNCTIONS

Once the program is running, the display automatically tracks the progress of the program as it indexes through its sequence of segments. When it concludes its final instruction, the upper display alternates **Stop** with the **Process Value** and the lower display reverts to the instrument **SP1 Setpoint**.

RAMP

The upper display alternates between **SPR** and the moving **Process Value** while the lower display shows **Target Setpoint**. If **Holdback** is activated, the decimal point in the lower right corner of the upper display will be illuminated.

SOAK

The upper display alternates between **SoAK** and the **Process Value**. The lower display reads the **Target Setpoint** of the current segment.

STEP (not displayed)

As this involves an instantaneous change of the **Target Setpoint**, this segment occupies zero time and the program immediately moves to the next segment. The lower display then registers the new **Target Setpoint**, with the upper display alternating in either **SPR** or **SoAK** mode according to the segment configuration.

HOLD

If the program is paused in **HOLD**, the upper display alternates between **hold** and the **Process Value**, while the lower display indicates the **Target Setpoint** of the current segment.

User Displays

With the program running, a further display function is available at any time.

Press and hold ***** Display shows Program Number

Also press **▲** once Display shows Segment Number

Press **▲** again Display shows number of loops completed if a loop function has been set.

Press **▲** again Upper display reads **t.SP**

Or if in Soak Segment Lower display shows moving **Ramp setpoint**

Upper display reads **SInt** (Soak interval)

Lower display reads remaining **Soak** time

Release ***** To return display to Program Run mode

† See examples of EDIT procedures (page 18) and example of a configured Program on page 13.

EXAMPLE PROGRAM

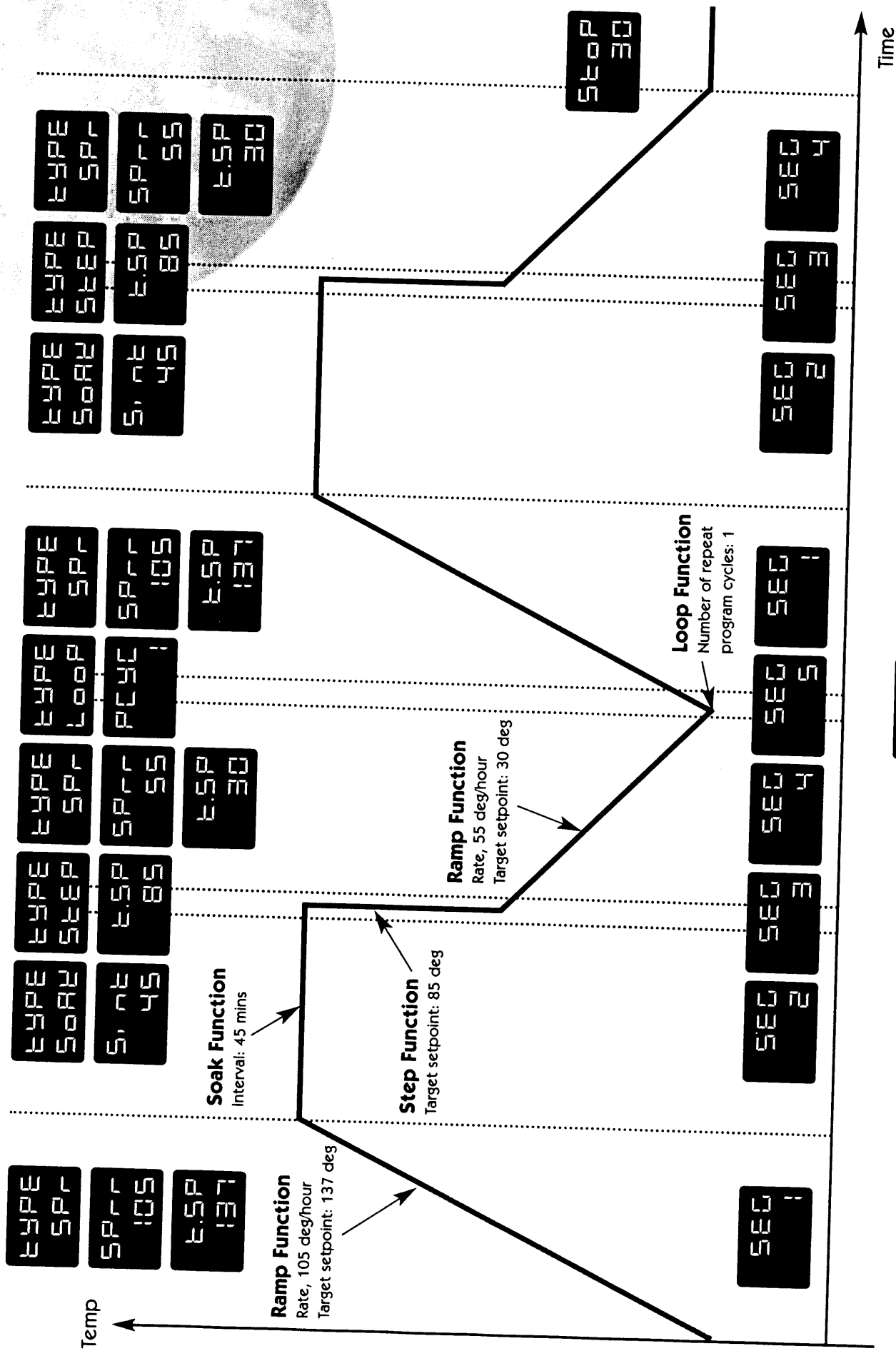

See segment configuration of this program detailed on page 18.

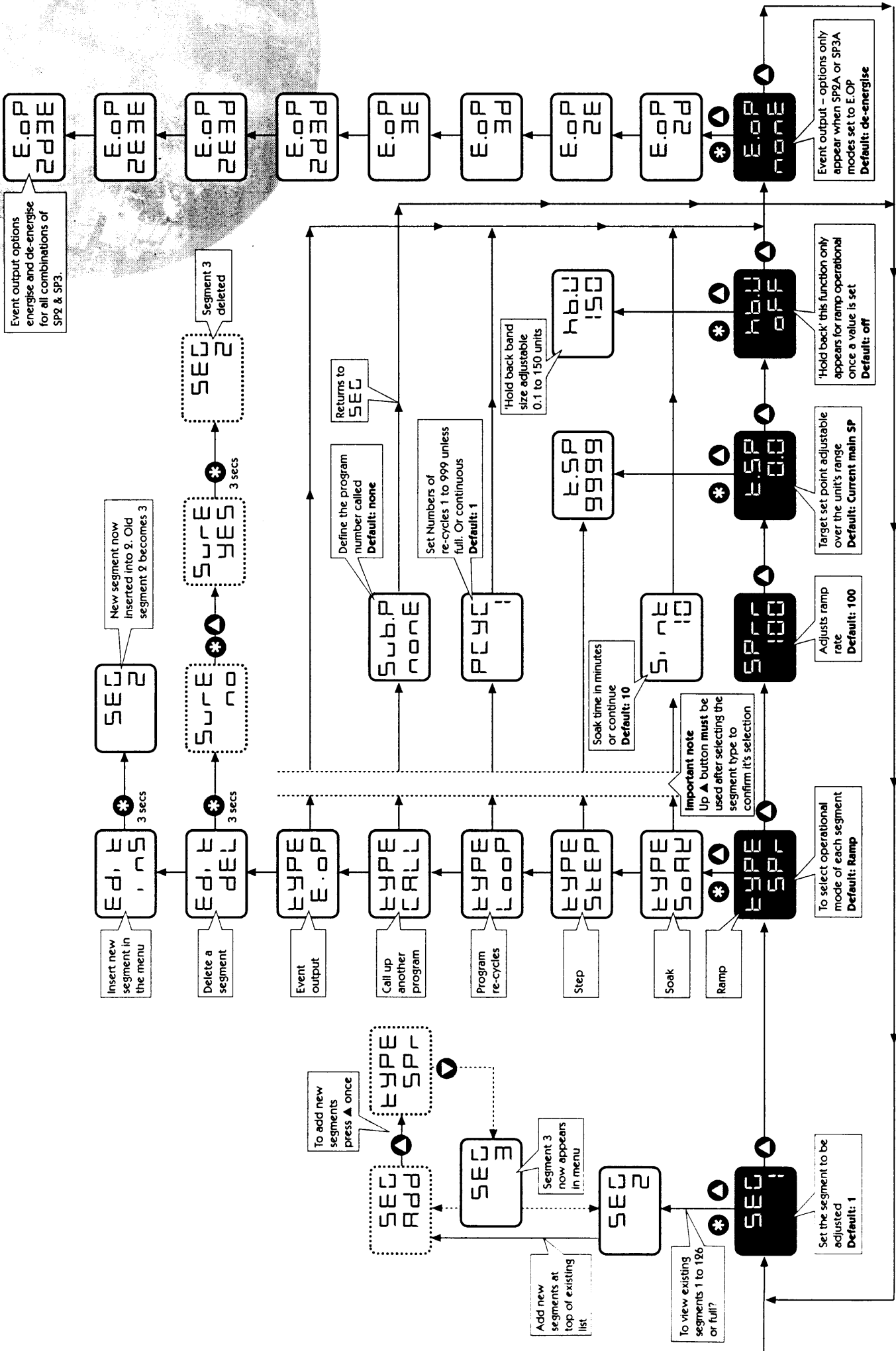

Function

Press ▲ or ▼ to change

E.oP Event output**Settings** (Factory settings) shown in brackets

Press * ▲ or * ▼ to change

[none]

Function can be applied to each segment independently to trigger an output at the end of that segment. Setting blocked unless either or both outputs SP2A or SP3A have been configured as an **Event Output** in Level 2 or Level A respectively.

- 2d** SP2A de-energised to mark event
- 2E** SP2A energised to mark event
- 3d** SP3A de-energised to mark event
- 3E** SP3A energised to mark event
- 2d.3d** SP2A and SP3A de-energised to mark event
- 2E.3d** SP2A energised SP3A de-energised to mark event
- 2E.3E** SP2A and SP3A energised to mark event
- 2d.3E** SP2A de-energised SP3A energised to mark event

To Return to:**LEVL P** Press and hold ▼**To Read % Programmer memory used:**

USED Press * and ▼ together in LEVL P / ProG 1
1-100%

Memory Allocation Table

Segment type	Memory required
Ramp	4 Bytes
Ramp with Holdback	5 Bytes
Soak	2 Bytes
Step	3 Bytes
Loops (1-3)	1 Byte
Loops (4+)	2 Bytes
Call	1 Byte
Event Output	1 Byte
Program Header	1 Byte

Maximum capacity: 351 Bytes

31 Programs

126 Segments

Examples:

1. 1 program of 58 Ramps and 58 Soaks 349 Bytes
2. 4 programs of 14 Ramps and 14 Soaks 340 Bytes
3. 31 programs of 2 Ramps and 1 Soak 341 Bytes
4. 2 programs of 10 Ramps, 10 Soaks, 2 Steps and 1 loop 136 Bytes

Memory Full Indication

Should the programmer memory capacity be reached during program configuration, the display will show 'FULL'

PROGRAMMING EXAMPLES

Program Edit Function
 Make copy of Program 1 and paste as new Program 2

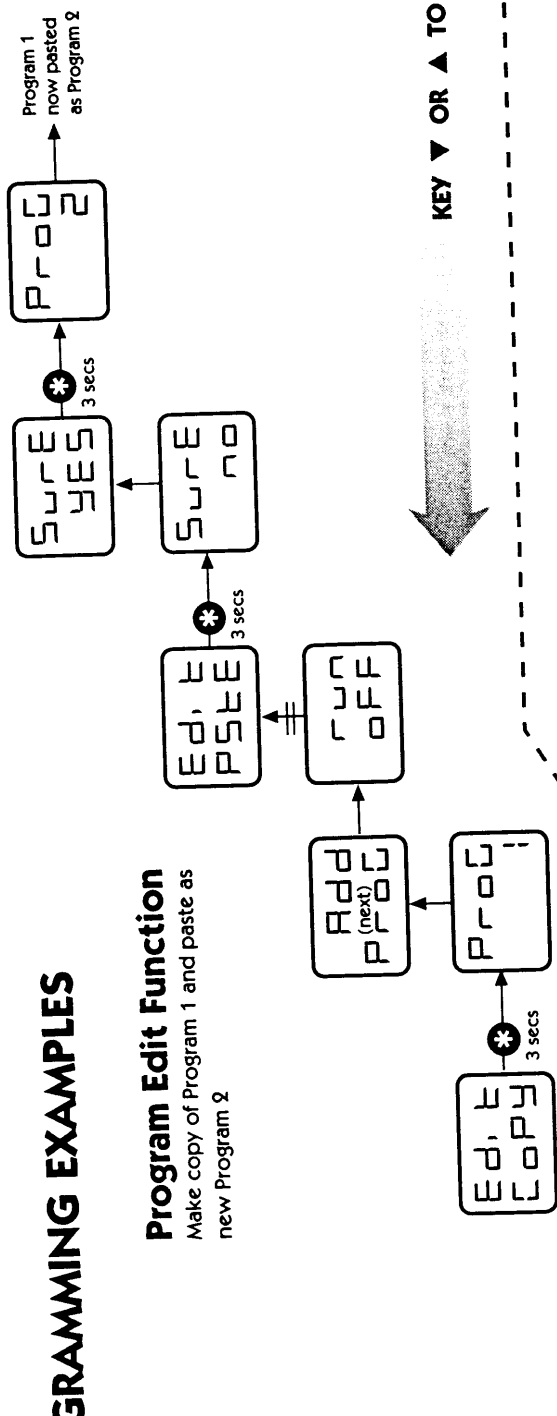

KEY

- Arrows drawn thus signify several key operations
- Programmer functions shown as white characters on black background have Default settings

KEY ▼ OR ▲ TO VIEW FUNCTIONS

Program Segment Configuration

See Program 3 illustrated on page 13

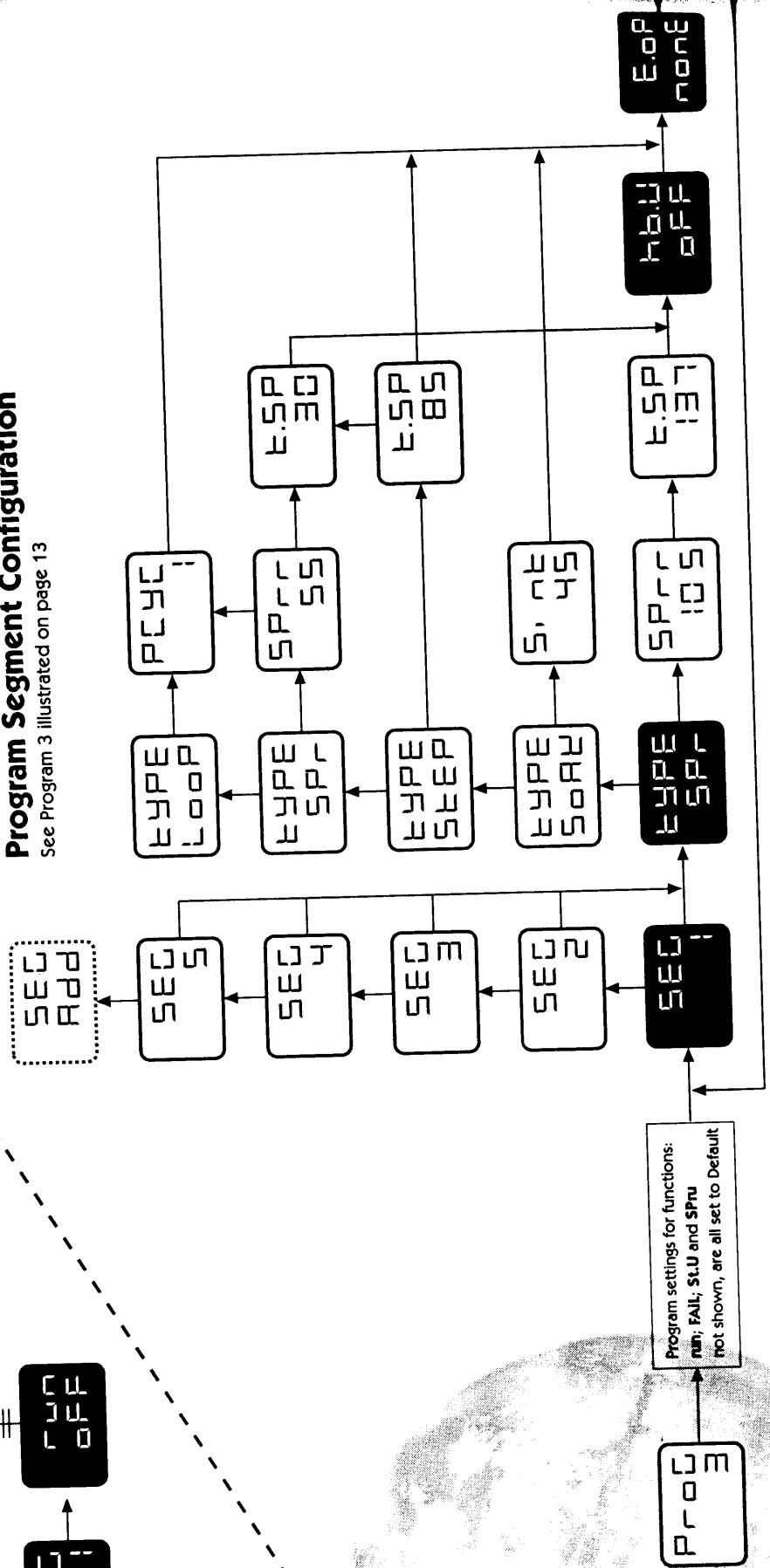

KEY * ▲ OR * ▼ TOGETHER TO VIEW OR CHANGE SETTINGS

MECHANICAL INSTALLATION

The Controller is designed to be sleeve mounted in a 1/16 DIN panel cutout with only the front panel rated to NEMA4/IP66, provided that:

- the panel is smooth and the panel cutout is accurate;
- the mounting instructions are carefully followed.

DIN PANEL CUTOUT

1/16 DIN: 45.0mm +0.6 / -0.0 wide, 45.0mm +0.6 / -0.0 high

Maximum panel thickness 9.5mm

Minimum spacing 20mm vertical, 10mm horizontal

MOUNTING

To mount a Controller proceed as follows:

- 1 Check that the controller is correctly orientated and then slide the unit into the cutout.
- 2 Slide the panel clamp over the controller sleeve pressing it firmly against the panel until the controller is held firmly.
- 3 The controller front bezel and circuit board assembly can be unplugged from the sleeve. Grasp the bezel firmly by the recesses on each side and pull. A screwdriver can be used as a lever if required.
- 4 When refitting the bezel assembly it is important to press it firmly into the sleeve until the latch clicks in order to compress the gasket and seal to NEMA4/IP66.

CLEANING

Wipe down with damp cloth (water only)



CAUTION: The controller should be isolated before removing or refitting it in its sleeve. Live circuits can hold a charge for short periods after isolation from voltage supply. Electrostatic precautions should be observed when handling the controller outside it's sleeve.

DIMENSIONS

Width	Behind Panel		Overall Length	Behind panel Length*
	Width	Height		
51.0	44.8	44.8	116.2	106.7

Dimensions in mm
* includes gasket

ELECTRICAL INSTALLATION

(See Important Safety Information page 20)

OUTPUT DEVICES

WARNING:

Three types of output device may be factory fitted to the controllers, and users must choose how to allocate these to outputs SP1 and SP2. (SP3 is always RLY). Check the model number and output configuration against the **Output Options Table on page 8** before wiring the instrument and applying power.

- 1 **Solid state relay drive (SSd1/SSd2)**
6Vdc (nominal) 20mA max.
To switch remote SSR (or logic)
2A/250V AC resistive, Form A/SPST contacts.
- 2 **Miniature power relay (rLY/rLY1/rLY3)**
2A/250V AC resistive, Form A/SPST contacts.
- 3 **Analogue Output (AnLG) (isolated)**
Specify; 4–20mA 500Ω max +/- 0.1% fs typical
0–5Vdc 10mA (500Ω min) +/- 0.1% fs typical
0–10Vdc 10mA (1KΩ min) +/- 0.1% fs typical

SUPPLY VOLTAGE

100–240V 50–60HZ 6.0VA (nominal)
+/- 10% maximum permitted fluctuation

WIRING THE CONNECTOR

Prepare the cable carefully, remove a maximum of 8mm insulation and ideally tin to avoid bridging. Prevent excessive cable strain. Maximum recommended wire size: 32/0.2mm 1.0mm² (18AWG).

INDUCTIVE LOADS

To prolong relay contact life and suppress interference it is recommended engineering practice to fit a snubber (0.1uF/100 ohms) between relay output terminals.

CAUTION:

Snubber leakage current can cause some electro-mechanical devices to be held ON. Check with the manufacturers specifications.

EN61010 - /CSA 22.2 No 1010.1 92

Compliance shall not be impaired when fitted to the final installation. Designed to offer a minimum of Basic Insulation only. The body responsible for the installation is to ensure that supplementary insulation suitable for Installation Category II or III is achieved when fully installed. To avoid possible hazards, accessible conductive parts of the final installation should be protectively earthed in accordance with EN61010 for Class 1 Equipment.

Output wiring should be within a Protectively Earthed cabinet.

* Sensor sheaths should be bonded to protective earth or not be accessible.

Live parts should not be accessible without the use of a tool.

When fitted to the final installation, an IEC/CSA APPROVED disconnecting device should be used to disconnect both LINE and NEUTRAL conductors simultaneously.

A clear instruction shall be provided not to position the equipment so that it is difficult to operate the disconnecting device.

* EMC Immunity

EMC immunity may be improved by fitting large Ferrite cores around the sensor cables at the point where they enter the cabinet and an earth bond is recommended.

TYPICAL APPLICATION

In this example the load temperature is monitored by a temperature transducer/transmitter which provides a 4-20mA input signal to the controller. The 4-20mA output has been allocated to SP1 to drive an SCR power controller providing a phase angle controlled output to the heater.

F1 Fuse: 1A time lag type to IEC127. CSA/UL rating 250Vac

F2 Fuse: High Rupture Capacity (HRC) Suitable for maximum rated load current

S1 Switch: IEC/CSA/UL Approved disconnecting device.

TYPICAL APPLICATION

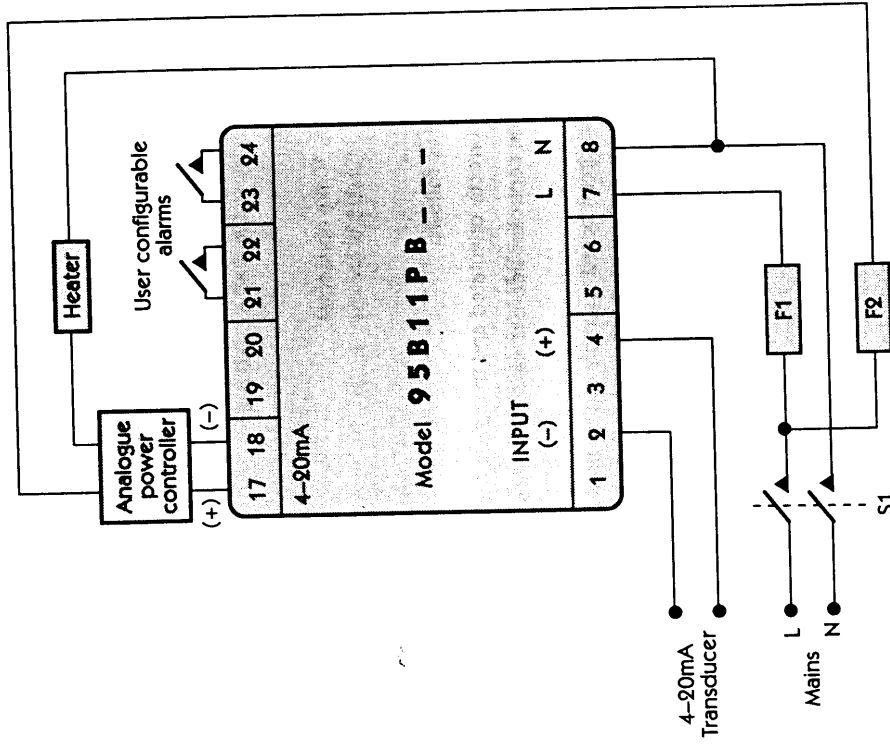

INPUT OPTIONS

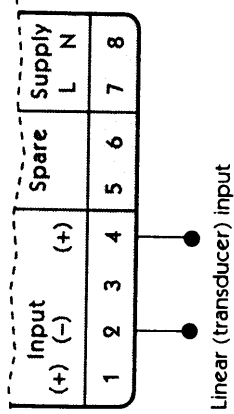
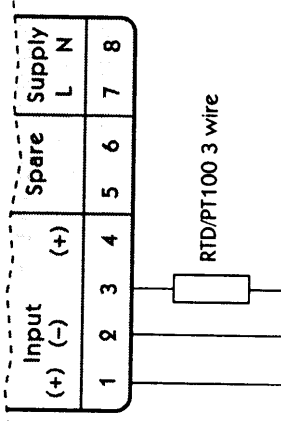
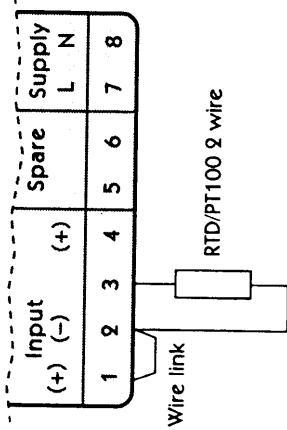
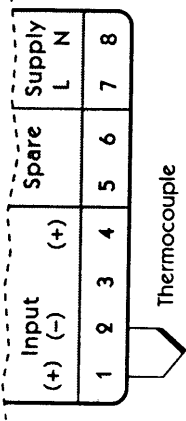

Standard Input Code

9 5 --- P A

Linear Input Codes

9 5 --- P B = 4-20mA

9 5 --- P C = 0-5V

9 5 --- P D = 0-10V

OUTPUT: HARDWARE OPTIONS & TERMINATIONS

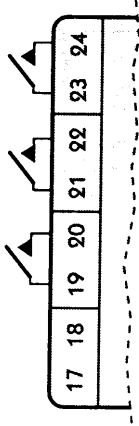

Model Output Codes

9 5 1 1 1 P

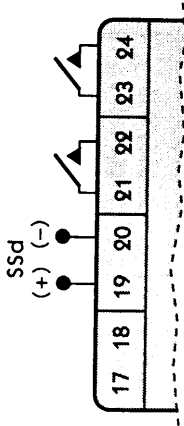

9 5 0 0 1 P

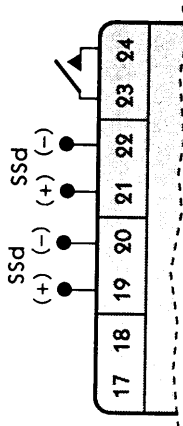

9 5 2 2 1 P

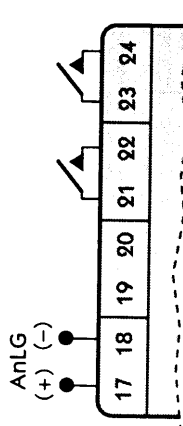

9 5 B 1 1 P = 4-20mA

9 5 C 1 1 P = 0-5V

9 5 D 1 1 P = 0-10V

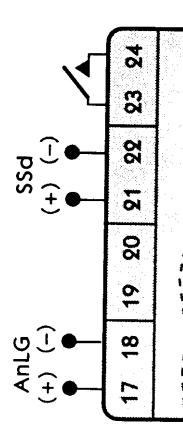

9 5 B 2 1 P = 4-20mA

9 5 C 2 1 P = 0-5V

9 5 D 2 1 P = 0-10V

Relay = 1 SSd = 2 Analogue = B/C/D

The analogue output always replaces the output on terminals 19 & 20.

INPUT SENSOR SELECTION Temperature sensors

Thermocouples	Description	Sensor range	Linearity
tC b	Pt-30%Rh/Pt-6%Rh	0 to 1800 °C	2.0 *
tC E	Chromel/Con	0 to 600 °C	0.5
tC J	Iron/Constantan	0 to 800 °C	0.5
tC K	Chromel/Alumel	-50 to 1200 °C	0.25*
tC L	Fe/Konst	0 to 800 °C	0.5
tC n	NiCrosil/NiSil	-50 to 1200 °C	0.25*
tC r	Pt-13%Rh/Pt	0 to 1600 °C	2.0*
tC s	Pt-10%Rh/Pt	0 to 1600 °C	2.0*
tC t	Copper/Con	-200 / 250 °C	0.25*
Resistance thermometer			
rtd 2/3 wire	Pt100/RTD-2/3	-200 / 400 °C	0.25*

Notes: 1 Linearity: 5-95% sensor range
 2 * Linearity B:5° (70° - 500°C) K/N:1° >350°C
 exceptions: R/S: 5° <300°C T:1° <-25° >150°C
 RTD/Pt100: 0.5° <-100°C

Linear input (specification)

Maximum recommended display resolution: 1mV / 500°

Linear Input	Typical accuracy	Range
0-50mV	+/- 0.1%	-199 to 9999
4-20mA	+/- 0.1%	-199 to 9999
0-5	+/- 0.1%	-199 to 9999
0-10V	+/- 0.1%	-199 to 9999

SPECIFICATION

Thermocouple
9 types

Standards: IEC 584-1-1:EN60584-1
CJC rejection: 20:1 (0.05°C) typical
External resistance: 100Ω maximum

Resistance thermometer

RTD-2/Pt100

Standards:

IEC 751:EN60751

(100Ω 0°C/138.5Ω 100°C Pt)

0.2mA maximum

Bulb current:

Linear process inputs see Linear input (specification)

mV range: 0 to 50mV

Applicable to all inputs SM = sensor maximum

Calibration accuracy: ±0.25% SM ±1°C

Sampling frequency: Input 10Hz, CJC 2 sec.

Common mode rejection: Negligible effect up to 140dB, 240V, 50-60Hz

Series mode rejection: 60dB, 50-60Hz

Temperature coefficient: 50ppm/°C SM typical

Reference conditions: 22°C ±2°C, rated voltage after 15 minutes settling time.

Output devices check configuration

SSd1 and SSd2:

solid state relay driver: To switch a remote SSR

6Vdc (nominal) 20mA non-isolated

form A/SPST contacts (AgCdO)

2A/250ac resistive load

4-20mA 500Ω max +/- 0.1% fs typical

0-5Vdc 10mA (500Ω min) +/- 0.1% fs typical

0-10Vdc 10mA (1KΩ min) +/- 0.1% fs typical

Miniature power relay:

rLY, rLY1 and rLY3:

Analogue output:

General

Displays:

Upper, 4 Digits, high brightness
green LED. 10mm (0.4") high.

Lower, 4 Digits, high brightness Orange LED
9mm (0.35") high

Digital range -199 to 9999

Hi-res mode -199.9 to 999.9

LED output indicators - flashing

SP1 square, green; SP2/SP3 round, red

3 elastomeric buttons

Keypad:

Environmental

Humidity:

Max 95% (non condensing)

up to 2000M

Altitude:

Categories II and III

Installation:

Degree II

Pollution:

NEMA 4X, IP66 (Front panel only)

Protection:

EN50081-1 FCC Rules 15 subpart J Class A

EMC emission:

EN50082-2

EMC immunity:

0-50°C (32-130°F)

Ambient:

flame retardant polycarbonate

Mouldings:

180g (6.4 oz)

SAFETY AND WARRANTY INFORMATION



INSTALLATION

Designed for use:

UL873 - only in products where the acceptability is determined by Underwriters Laboratories Inc.

EN61010-1 / CSA 22.2 No 1010.1 - 92

To offer a minimum of Basic Insulation only.

Suitable for installation within Category II and III and Pollution Degree 2.

SEE ELECTRICAL INSTALLATION Page 19

It is the responsibility of the installation engineer to ensure this equipment is installed as specified in this manual and is in compliance with appropriate wiring regulations.

CONFIGURATION

All functions are front selectable, it is the responsibility of the installing engineer to ensure that the configuration is safe. Use the program lock to protect critical functions from tampering.

ULTIMATE SAFETY ALARMS

Do not use SP2/SP3 as the sole alarm where personal injury or damage may be caused by equipment failure.

WARRANTY

CAL Controls warrant this product free from defect in workmanship and materials for three (3) years from date of purchase.

- 1 Should the unit malfunction, return it to the factory. If defective it will be repaired or replaced at no charge.
- 2 There are no user-servisable parts in this unit. This warranty is void if the unit shows evidence of being tampered with or subjected to excessive heat, moisture, corrosion or other misuse.
- 3 Components which wear, or damage with misuse, are excluded e.g. relays.
- 4 CAL Controls shall not be responsible for any damage or losses however caused, which may be experienced as a result of the installation or use of this product.

CAL Controls liability for any breach of this agreement shall not exceed the purchase price paid E. & O.E.

Copyright CAL Controls Ltd. 2000

Not to be reproduced without prior written permission from CAL Controls Ltd. Whilst every effort has been made to ensure the accuracy of the specifications contained in this manual, due to our policy of continuous development, CAL Controls Ltd reserves the right to make changes without prior notice.