

General Description

The AOK53S60 has been fabricated using the advanced α MOS™ high voltage process that is designed to deliver high levels of performance and robustness in switching applications. By providing low $R_{DS(on)}$, Q_g and E_{OSS} along with guaranteed avalanche capability this part can be adopted quickly into new and existing offline power supply designs.

For Halogen Free add "L" suffix to part number:
 AOK53S60L

Product Summary

| | |
|----------------------|---------------|
| $V_{DS} @ T_{j,max}$ | 700V |
| I_{DM} | 215A |
| $R_{DS(ON),max}$ | 0.07 Ω |
| $Q_{g,typ}$ | 59nC |
| $E_{OSS} @ 400V$ | 15 μ J |

100% UIS Tested
 100% R_g Tested



Top View
 TO247

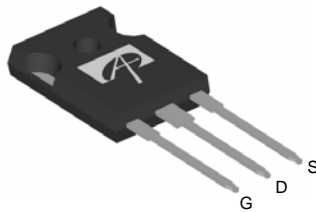

AOK53S60

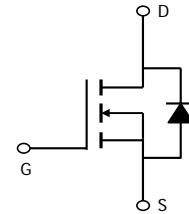
Absolute Maximum Ratings $T_A=25^\circ\text{C}$ unless otherwise noted

| Parameter | Symbol | AOK53S60 | Units |
|---|----------------|---------------------------------|------------------|
| Drain-Source Voltage | V_{DS} | 600 | V |
| Gate-Source Voltage | V_{GS} | ± 30 | V |
| Continuous Drain Current | I_D | $T_C=25^\circ\text{C}$ | 53 |
| | | $T_C=100^\circ\text{C}$ | 33 |
| Pulsed Drain Current ^C | I_{DM} | 215 | A |
| Avalanche Current ^C | I_{AR} | 9.5 | A |
| Repetitive avalanche energy ^C | E_{AR} | 45 | mJ |
| Single pulsed avalanche energy ^G | E_{AS} | 1688 | mJ |
| Power Dissipation ^B | P_D | $T_C=25^\circ\text{C}$ | 520 |
| | | Derate above 25°C | 4.2 |
| MOSFET dv/dt ruggedness | dv/dt | 100 | V/ns |
| Peak diode recovery dv/dt | dv/dt | 20 | V/ns |
| Junction and Storage Temperature Range | T_J, T_{STG} | -55 to 150 | $^\circ\text{C}$ |
| Maximum lead temperature for soldering purpose, 1/8" from case for 5 seconds ^J | T_L | 300 | $^\circ\text{C}$ |

Thermal Characteristics

| Parameter | Symbol | AOK53S60 | Units |
|--|-----------------|----------|--------------------|
| Maximum Junction-to-Ambient ^{A,D} | $R_{\theta JA}$ | 40 | $^\circ\text{C/W}$ |
| Maximum Case-to-sink ^A | $R_{\theta CS}$ | 0.5 | $^\circ\text{C/W}$ |
| Maximum Junction-to-Case | $R_{\theta JC}$ | 0.24 | $^\circ\text{C/W}$ |

Electrical Characteristics (T_J=25°C unless otherwise noted)

| Symbol | Parameter | Conditions | Min | Typ | Max | Units |
|-----------------------------|---|--|-----|-------|-------|-------|
| STATIC PARAMETERS | | | | | | |
| BV _{DSS} | Drain-Source Breakdown Voltage | I _D =250μA, V _{GS} =0V, T _J =25°C | 600 | - | - | V |
| | | I _D =250μA, V _{GS} =0V, T _J =150°C | 650 | 700 | - | |
| I _{DSS} | Zero Gate Voltage Drain Current | V _{DS} =600V, V _{GS} =0V | - | - | 1 | μA |
| | | V _{DS} =480V, T _J =150°C | - | 10 | - | |
| I _{GSS} | Gate-Body leakage current | V _{DS} =0V, V _{GS} =±30V | - | - | ±100 | nA |
| V _{GS(th)} | Gate Threshold Voltage | V _{DS} =5V, I _D =250μA | 2.5 | 3.2 | 3.8 | V |
| R _{DS(ON)} | Static Drain-Source On-Resistance | V _{GS} =10V, I _D =26.5A, T _J =25°C | - | 0.058 | 0.07 | Ω |
| | | V _{GS} =10V, I _D =26.5A, T _J =150°C | - | 0.155 | 0.185 | Ω |
| V _{SD} | Diode Forward Voltage | I _S =26.5A, V _{GS} =0V, T _J =25°C | - | 0.84 | - | V |
| I _S | Maximum Body-Diode Continuous Current | | - | - | 53 | A |
| I _{SM} | Maximum Body-Diode Pulsed Current | | - | - | 215 | A |
| DYNAMIC PARAMETERS | | | | | | |
| C _{iss} | Input Capacitance | V _{GS} =0V, V _{DS} =100V, f=1MHz | - | 3034 | - | pF |
| C _{oss} | Output Capacitance | | - | 222 | - | pF |
| C _{o(er)} | Effective output capacitance, energy related ^H | V _{GS} =0V, V _{DS} =0 to 480V, f=1MHz | - | 170 | - | pF |
| C _{o(tr)} | Effective output capacitance, time related ^I | | - | 524 | - | pF |
| C _{rss} | Reverse Transfer Capacitance | V _{GS} =0V, V _{DS} =100V, f=1MHz | - | 3 | - | pF |
| R _g | Gate resistance | V _{GS} =0V, V _{DS} =0V, f=1MHz | - | 1.8 | - | Ω |
| SWITCHING PARAMETERS | | | | | | |
| Q _g | Total Gate Charge | V _{GS} =10V, V _{DS} =480V, I _D =26.5A | - | 59 | - | nC |
| Q _{gs} | Gate Source Charge | | - | 17 | - | nC |
| Q _{gd} | Gate Drain Charge | | - | 19 | - | nC |
| t _{D(on)} | Turn-On Delay Time | V _{GS} =10V, V _{DS} =400V, I _D =26.5A, R _G =25Ω | - | 48 | - | ns |
| t _r | Turn-On Rise Time | | - | 102 | - | ns |
| t _{D(off)} | Turn-Off Delay Time | | - | 215 | - | ns |
| t _f | Turn-Off Fall Time | | - | 122 | - | ns |
| t _{rr} | Body Diode Reverse Recovery Time | I _F =26.5A, dl/dt=100A/μs, V _{DS} =400V | - | 664 | - | ns |
| I _{rm} | Peak Reverse Recovery Current | I _F =26.5A, dl/dt=100A/μs, V _{DS} =400V | - | 36 | - | A |
| Q _{rr} | Body Diode Reverse Recovery Charge | I _F =26.5A, dl/dt=100A/μs, V _{DS} =400V | - | 14 | - | μC |

A. The value of R_{θJA} is measured with the device in a still air environment with T_A=25°C.

B. The power dissipation P_D is based on T_{J(MAX)}=150°C, using junction-to-case thermal resistance, and is more useful in setting the upper dissipation limit for cases where additional heatsinking is used.

C. Repetitive rating, pulse width limited by junction temperature T_{J(MAX)}=150°C, Ratings are based on low frequency and duty cycles to keep initial T_J=25°C.

D. The R_{θJA} is the sum of the thermal impedance from junction to case R_{θJC} and case to ambient.

E. The static characteristics in Figures 1 to 6 are obtained using <300 μs pulses, duty cycle 0.5% max.

F. These curves are based on the junction-to-case thermal impedance which is measured with the device mounted to a large heatsink, assuming a maximum junction temperature of T_{J(MAX)}=150°C. The SOA curve provides a single pulse rating.

G. L=60mH, I_{AS}=7.5A, V_{DS}=150V, Starting T_J=25°C

H. C_{o(er)} is a fixed capacitance that gives the same stored energy as C_{oss} while V_{DS} is rising from 0 to 80% V_{(BR)DSS}.

I. C_{o(tr)} is a fixed capacitance that gives the same charging time as C_{oss} while V_{DS} is rising from 0 to 80% V_{(BR)DSS}.

J. Wavesoldering only allowed at leads.

THIS PRODUCT HAS BEEN DESIGNED AND QUALIFIED FOR THE CONSUMER MARKET. APPLICATIONS OR USES AS CRITICAL COMPONENTS IN LIFE SUPPORT DEVICES OR SYSTEMS ARE NOT AUTHORIZED. AOS DOES NOT ASSUME ANY LIABILITY ARISING OUT OF SUCH APPLICATIONS OR USES OF ITS PRODUCTS. AOS RESERVES THE RIGHT TO IMPROVE PRODUCT DESIGN, FUNCTIONS AND RELIABILITY WITHOUT NOTICE.

TYPICAL ELECTRICAL AND THERMAL CHARACTERISTICS

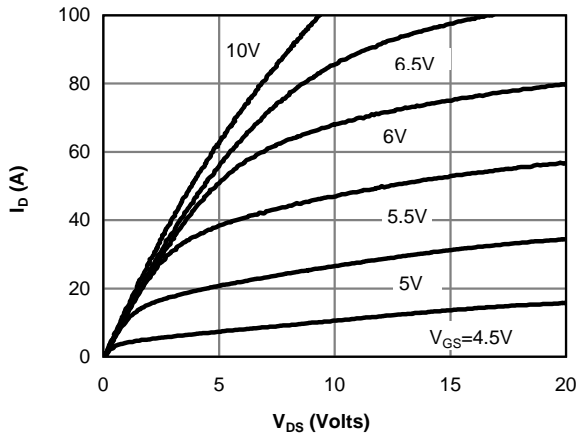

Figure 1: On-Region Characteristics @25°C

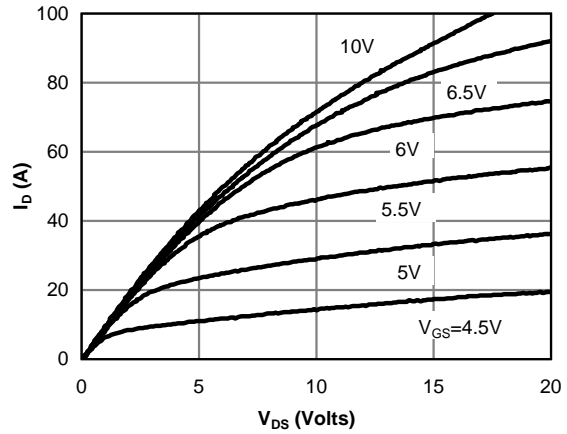

Figure 2: On-Region Characteristics @125°C

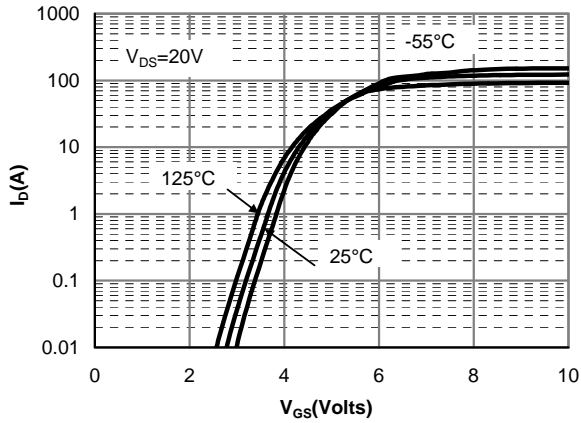

Figure 3: Transfer Characteristics

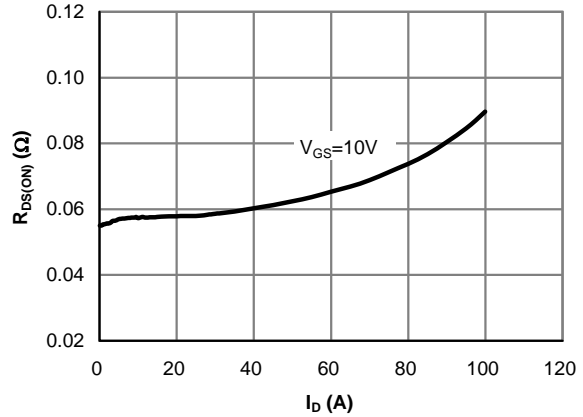

Figure 4: On-Resistance vs. Drain Current and Gate Voltage

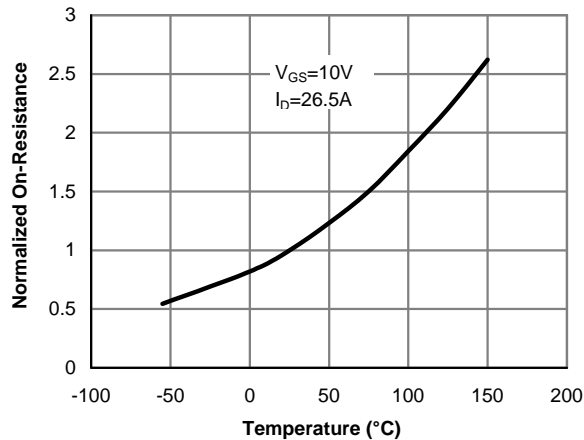

Figure 5: On-Resistance vs. Junction Temperature

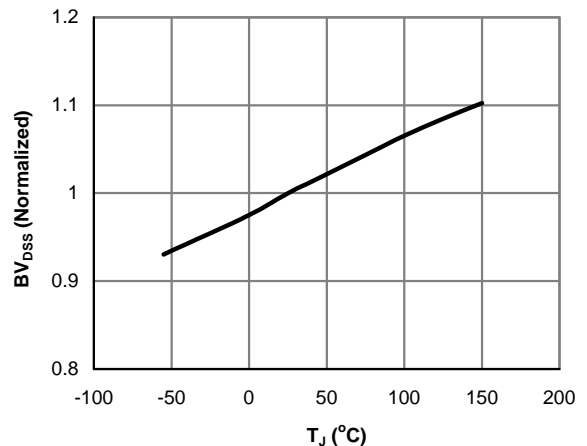

Figure 6: Break Down vs. Junction Temperature

TYPICAL ELECTRICAL AND THERMAL CHARACTERISTICS

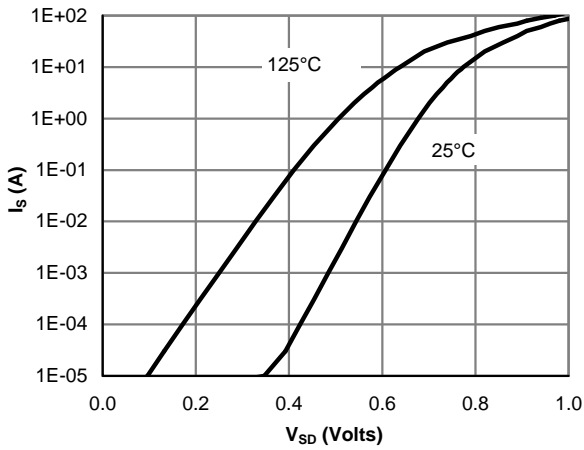

Figure 7: Body-Diode Characteristics (Note E)

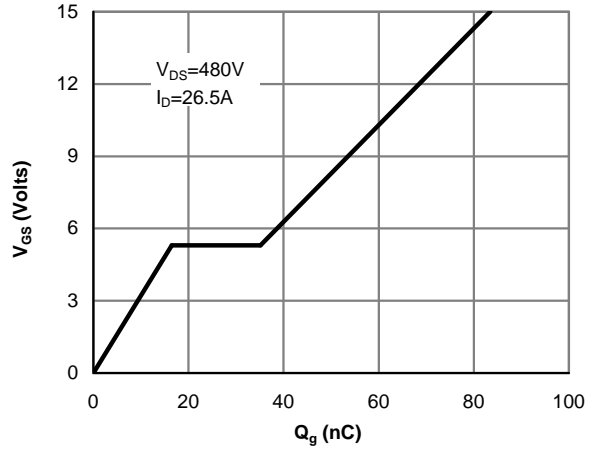

Figure 8: Gate-Charge Characteristics

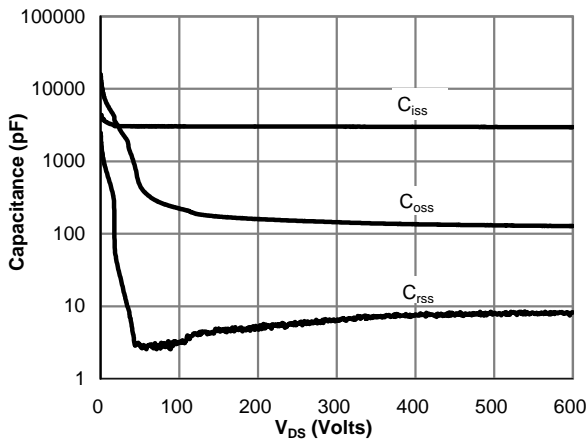

Figure 9: Capacitance Characteristics

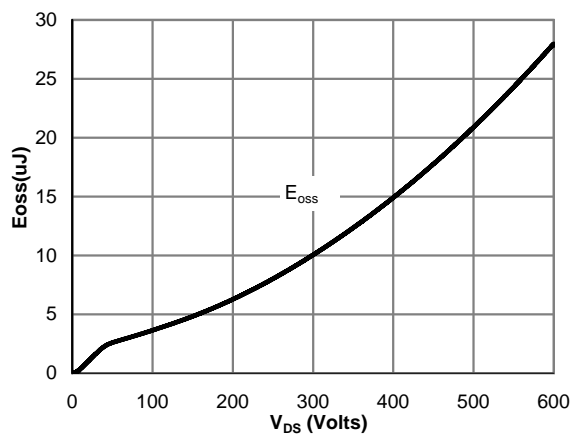

Figure 10: Coss stored Energy

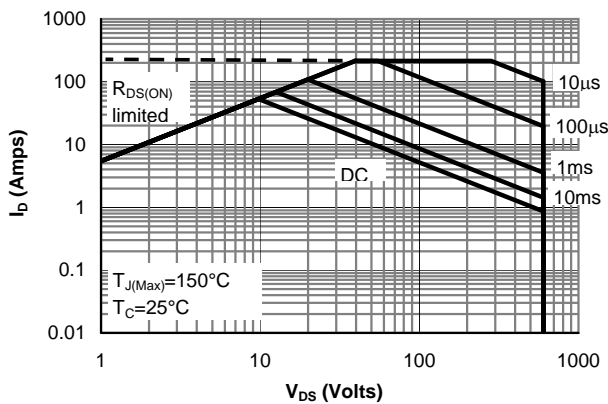

Figure 11: Maximum Forward Biased Safe Operating Area for AOK53S60 (Note F)

TYPICAL ELECTRICAL AND THERMAL CHARACTERISTICS

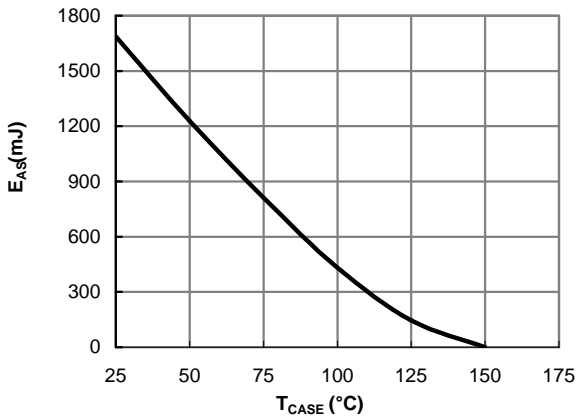

Figure 12: Avalanche energy

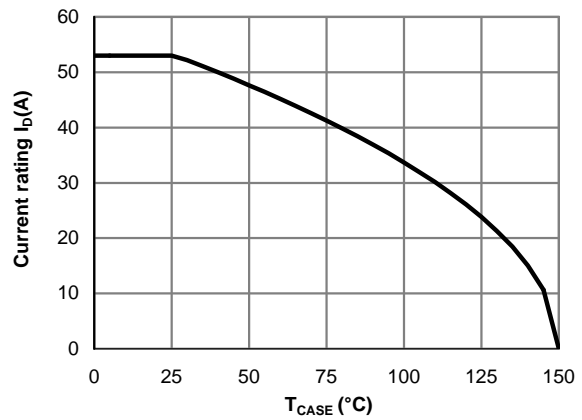

Figure 13: Current De-rating (Note B)

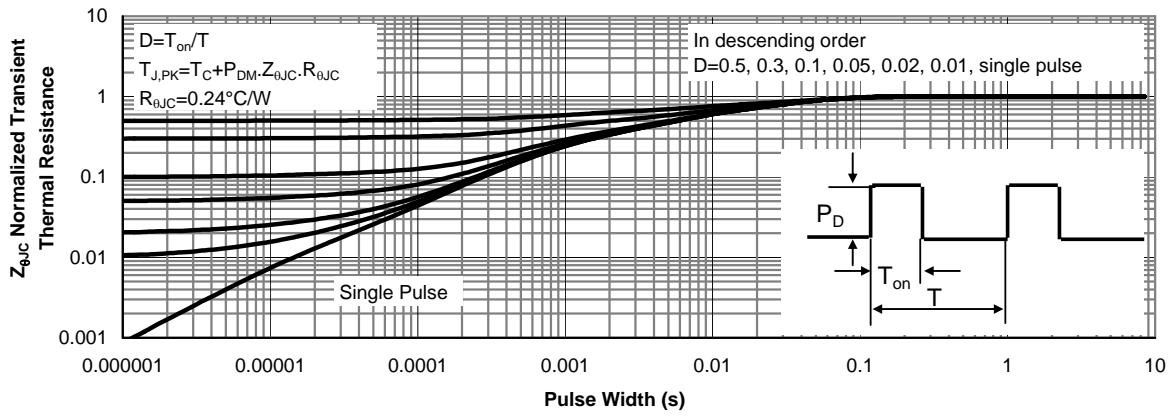
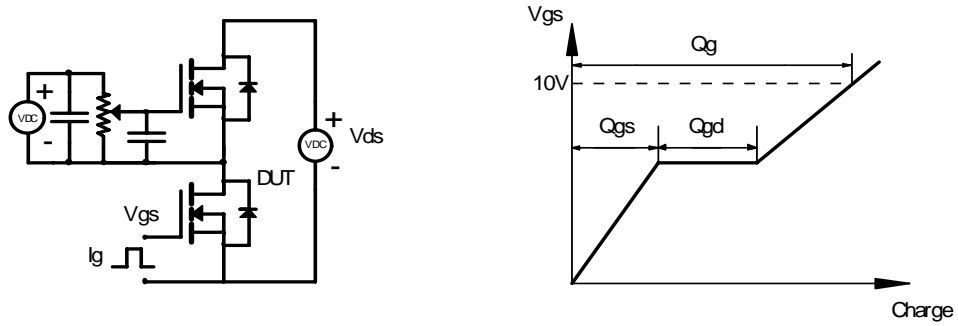
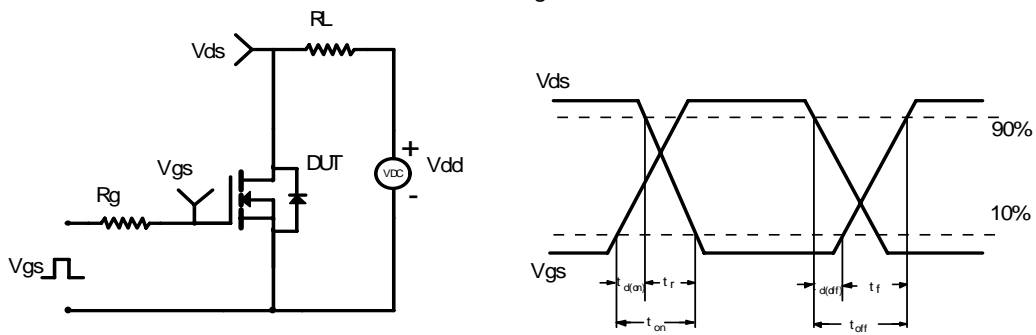

Figure 14: Normalized Maximum Transient Thermal Impedance for AOK53S60 (Note F)

Gate Charge Test Circuit & Waveform



Resistive Switching Test Circuit & Waveforms



Unclamped Inductive Switching (UIS) Test Circuit & Waveforms

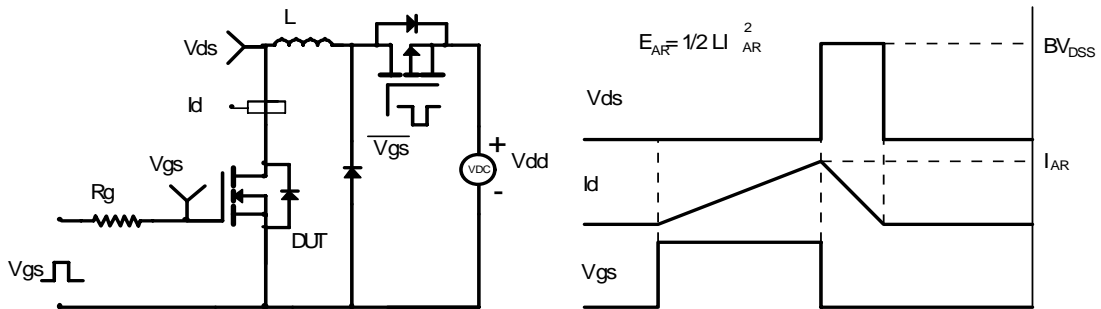

Diode Recovery Test Circuit & Waveforms

