



## +5V, RS-232 Transceivers with 0.1µF External Capacitors

MAX200-MAX211/MAX213

### General Description

The MAX200-MAX211/MAX213 transceivers are designed for RS-232 and V.28 communication interfaces where ±12V supplies are not available. On-board charge pumps convert the +5V input to the ±10V needed for RS-232 output levels. The MAX201 and MAX209 operate from +5V and +12V, and contain a +12V to -12V charge-pump voltage converter.

The MAX200-MAX211/MAX213 drivers and receivers meet all EIA/TIA-232E and CCITT V.28 specifications at a data rate of 20kbps. The drivers maintain the ±5V EIA/TIA-232E output signal levels at data rates in excess of 120kbps when loaded in accordance with the EIA/TIA-232E specification.

The 5µW shutdown mode of the MAX200, MAX205, MAX206, and MAX211 conserves energy in battery-powered systems. The MAX213 has an active-low shutdown and an active-high receiver enable control. Two receivers of the MAX213 are active, allowing ring indicator (RI) to be monitored easily using only 75µW power.

The MAX211 and MAX213 are available in a 28-pin wide small-outline (SO) package and a 28-pin shrink small-outline (SSOP) package, which occupies only 40% of the area of the SO. The MAX207 is now available in a 24-pin SO package and a 24-pin SSOP. The MAX203 and MAX205 use no external components, and are recommended for applications with limited circuit board space.

### Applications

Computers  
Laptops, Palmtops, Notebooks  
Battery-Powered Equipment  
Hand-Held Equipment

### Next-Generation Device Features

- ◆ **For Low-Cost Applications:**  
MAX221E: ±15kV ESD-Protected, +5V, 1µA, Single RS-232 Transceiver with AutoShutdown™
- ◆ **For Low-Voltage and Space-Constrained Applications:**  
MAX3222E/MAX3232E/MAX3237E/MAX3241E/MAX3246E: ±15kV ESD-Protected, Down to 10nA, +3.0V to +5.5V, Up to 1Mbps, True RS-232 Transceivers (MAX3246E Available in UCSP™ Package)
- ◆ **For Space-Constrained Applications:**  
MAX3228E/MAX3229E: ±15kV ESD-Protected, +2.5V to +5.5V, RS-232 Transceivers in UCSP
- ◆ **For Low-Voltage or Data Cable Applications:**  
MAX3380E/MAX3381E: +2.35V TO +5.5V, 1µA, 2Tx/2Rx RS-232 Transceivers with ±15kV ESD-Protected I/O and Logic Pins
- ◆ **For Low-Power Applications:**  
MAX3224E-MAX3227E/MAX3244E/MAX3245E: ±15kV ESD-Protected, 1µA, 1Mbps, +3.0V to +5.5V, RS-232 Transceivers with AutoShutdown Plus™

Ordering Information appears at end of data sheet

AutoShutdown, AutoShutdown Plus, and UCSP are trademarks of Maxim Integrated Products, Inc.

### Selector Guide

Part Number	Power-Supply Voltage (V)	No. of RS-232 Drivers	No. of RS-232 Receivers	No. of Receivers Active in Shutdown	No. of External Capacitors (0.1µF)	Low-Power Shutdown/TTL Three-State
MAX200	+5	5	0	0	4	Yes/No
MAX201	+5 and +9.0 to +13.2	2	2	0	2	No/No
MAX202	+5	2	2	0	4	No/No
MAX203	+5	2	2	0	None	No/No
MAX204	+5	4	0	0	4	No/No
MAX205	+5	5	5	0	None	Yes/Yes
MAX206	+5	4	3	0	4	Yes/Yes
MAX207	+5	5	3	0	4	No/No
MAX208	+5	4	4	0	4	No/No
MAX209	+5 and +9.0 to +13.2	3	5	0	2	No/Yes
MAX211	+5	4	5	0	4	Yes/Yes
MAX213	+5	4	5	2	4	Yes/Yes



Maxim Integrated Products 1

For pricing, delivery, and ordering information, please contact Maxim/Dallas Direct! at 1-888-629-4642, or visit Maxim's website at [www.maxim-ic.com](http://www.maxim-ic.com).

## +5V RS-232 Transceivers with 0.1μF External Capacitors

### ABSOLUTE MAXIMUM RATINGS

V <sub>CC</sub> .....	-0.3V to +6V	20-Pin Plastic DIP (derate 11.11mW/°C above +70°C) ..	889mW
V <sub>+</sub> .....	(V <sub>CC</sub> - 0.3V) to +14V	20-Pin Wide SO (derate 10.00mW/°C above +70°C) ..	800mW
V <sub>-</sub> .....	+0.3V to -14V	20-Pin CERDIP (derate 11.11mW/°C above +70°C) ..	889mW
Input Voltages			
T <sub>IN</sub> .....	-0.3V to (V <sub>CC</sub> + 0.3V)	24-Pin Narrow Plastic DIP (derate 13.33mW/°C above +70°C) ..	1067mW
R <sub>IN</sub> .....	±30V	24-Pin Wide Plastic DIP (derate 9.09mW/°C above +70°C) ..	727mW
Output Voltages			
T <sub>OUT</sub> .....	(V <sub>+</sub> + 0.3V) to (V <sub>-</sub> - 0.3V)	24-Pin Wide SO (derate 11.76mW/°C above +70°C) ..	941mW
R <sub>OUT</sub> .....	-0.3V to (V <sub>CC</sub> + 0.3V)	24-Pin SSOP (derate 8.00mW/°C above +70°C) ..	640mW
Short-Circuit Duration			
T <sub>OUT</sub> .....	Continuous	24-Pin CERDIP (derate 12.50mW/°C above +70°C) ..	1000mW
Continuous Power Dissipation (T <sub>A</sub> = +70°C)			
14-Pin Plastic DIP (derate 10.00mW/°C above +70°C) ..		28-Pin Wide SO (derate 12.50mW/°C above +70°C) ..	1000mW
16-Pin Plastic DIP (derate 10.53mW/°C above +70°C) ..		28-Pin SSOP (derate 9.52mW/°C above +70°C) ..	762mW
16-Pin SO (derate 8.70mW/°C above +70°C) ..			
16-Pin Wide SO (derate 9.52mW/°C above +70°C) ..			
16-Pin CERDIP (derate 10.00mW/°C above +70°C) ..			

Operating Temperature Ranges:	
MAX2__C__ .....	0°C to +70°C
MAX2__E__ .....	-40°C to +85°C
MAX2__M__ .....	-55°C to +125°C
Storage Temperature Range .....	
-65°C to +160°C	
Lead Temperature (soldering, 10sec) .....	
+300°C	

Stresses beyond those listed under "Absolute Maximum Ratings" may cause permanent damage to the device. These are stress ratings only, and functional operation of the device at these or any other conditions beyond those indicated in the operational sections of the specifications is not implied. Exposure to absolute maximum rating conditions for extended periods may affect device reliability.

### ELECTRICAL CHARACTERISTICS

(MAX202/204/206/208/211/213 V<sub>CC</sub> = 5V ±10%, MAX200/203/205/207 V<sub>CC</sub> = 5V ±5%, C1-C4 = 0.1μF, MAX201/MAX209 V<sub>CC</sub> = 5V ±10%, V<sub>+</sub> = 9.0V to 13.2V, T<sub>A</sub> = T<sub>MIN</sub> to T<sub>MAX</sub>, unless otherwise noted.)

PARAMETER	CONDITIONS	MIN	TYP	MAX	UNITS
Output Voltage Swing	All transmitter outputs loaded with 3kΩ to ground	±5	±8		V
V <sub>CC</sub> Power-Supply Current	No load, T <sub>A</sub> = +25°C	MAX202, MAX203	8	15	mA
		MAX200, MAX204-MAX208, MAX211, MAX213	11	20	
		MAX201, MAX209	0.4	1	
V <sub>+</sub> Power-Supply Current	No load	MAX201	5	10	mA
		MAX209	7	15	
Shutdown Supply Current	Figure 1, T <sub>A</sub> = +25°C	MAX200, MAX205, MAX206, MAX211	1	10	μA
		MAX213	15	50	
Input Logic Threshold Low	T <sub>IN</sub> , $\overline{EN}$ , SHDN, EN, SHDN			0.8	V
Input Logic Threshold High	T <sub>IN</sub>	2.0			V
	$\overline{EN}$ , SHDN, EN, SHDN	2.4			
Logic Pull-Up Current	T <sub>IN</sub> = 0V		15	200	μA
RS-232 Input Voltage Operating Range		-30		+30	V
Receiver Input Threshold Low	V <sub>CC</sub> = 5V, T <sub>A</sub> = +25°C	Active mode	0.8	1.2	V
		Shutdown mode, MAX213, R4, R5	0.6	1.5	
Receiver Input Threshold High	V <sub>CC</sub> = 5V, T <sub>A</sub> = +25°C	Active mode	1.7	2.4	V
		Shutdown mode, MAX213, R4, R5	1.5	2.4	
RS-232 Input Hysteresis	V <sub>CC</sub> = 5V, no hysteresis in shutdown	0.2	0.5	1.0	V
RS-232 Input Resistance	V <sub>CC</sub> = 5V, T <sub>A</sub> = +25°C	3	5	7	kΩ

## +5V RS-232 Transceivers with 0.1 $\mu$ F External Capacitors

### ELECTRICAL CHARACTERISTICS (continued)

(MAX202/204/206/208/211/213  $V_{CC} = 5V \pm 10\%$ , MAX200/203/205/207  $V_{CC} = 5V \pm 5\%$ , C1-C4 = 0.1 $\mu$ F, MAX201/MAX209  $V_{CC} = 5V \pm 10\%$ ,  $V_+ = 9.0V$  to 13.2V,  $T_A = T_{MIN}$  to  $T_{MAX}$ , unless otherwise noted.)

PARAMETER	CONDITIONS		MIN	TYP	MAX	UNITS
TTL/CMOS Output Voltage Low	$I_{OUT} = 3.2mA$ (MAX201, MAX202, MAX203), $I_{OUT} = 1.6mA$ (all others)				0.4	V
TTL/CMOS Output Voltage High	$I_{OUT} = 1.0mA$		3.5			V
TTL/CMOS Output Leakage Current	$\overline{EN} = V_{CC}$ , $EN = 0V$ , $0V \leq R_{OUT} \leq V_{CC}$			0.05	$\pm 10$	$\mu A$
Output Enable Time (Figure 2)	MAX205, MAX206, MAX209, MAX211, MAX213			600		ns
Output Disable Time (Figure 2)	MAX205, MAX206, MAX209, MAX211, MAX213			200		ns
Receiver Propagation Delay	MAX213	$\overline{SHDN} = 0V$ , R4, R5		4	40	$\mu s$
		$\overline{SHDN} = V_{CC}$		0.5	10	
	MAX200-MAX211			0.5	10	
Transmitter Output Resistance	$V_{CC} = V_+ = V_- = 0V$ , $V_{OUT} = \pm 2V$		300			$\Omega$
Transition Region Slew Rate	$C_L = 50pF$ to 2500pF, $R_L = 3k\Omega$ to 7k $\Omega$ , $V_{CC} = 5V$ , $T_A = +25^\circ C$ measured from +3V to -3V or -3V to +3V	MAX200, MAX202-MAX211, MAX213	3	5.5	30	V/ $\mu s$
		MAX201		4	30	
RS-232 Output Short-Circuit Current				$\pm 10$	$\pm 60$	mA
Maximum Data Rate	$R_L = 3k\Omega$ to 7k $\Omega$ , $C_L = 50pF$ to 1000pF, one transmitter		120			kbps

**MAX200-MAX211/MAX213**

# +5V RS-232 Transceivers with 0.1μF External Capacitors

## Typical Operating Characteristics

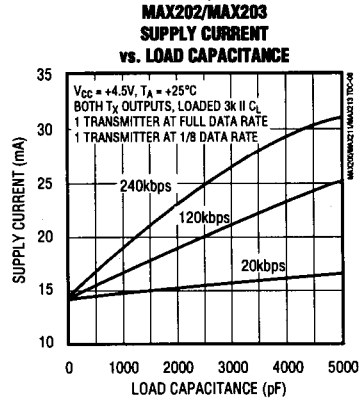
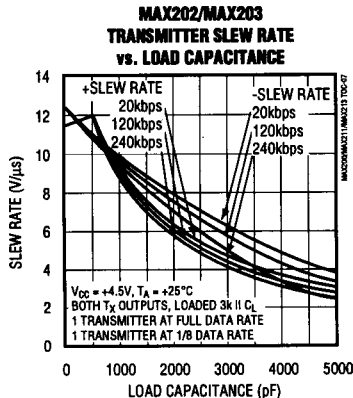
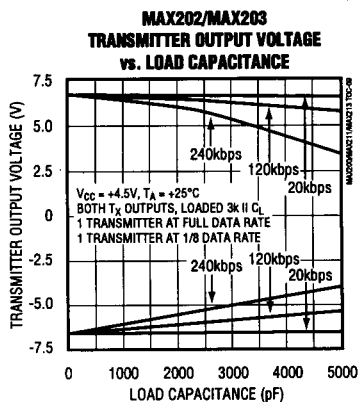
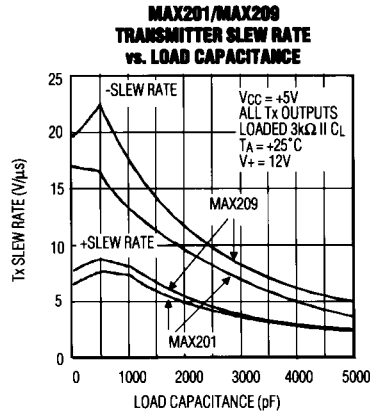
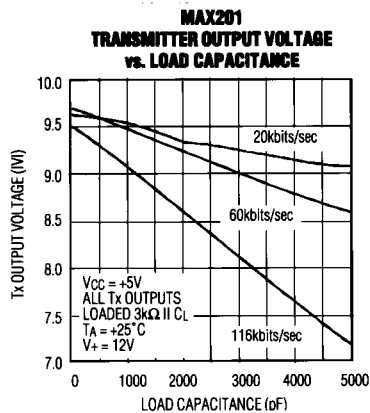
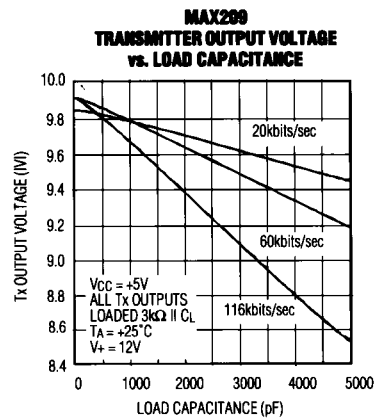
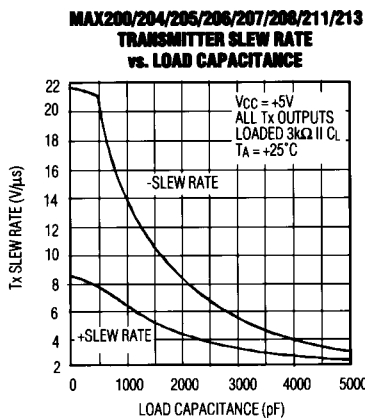
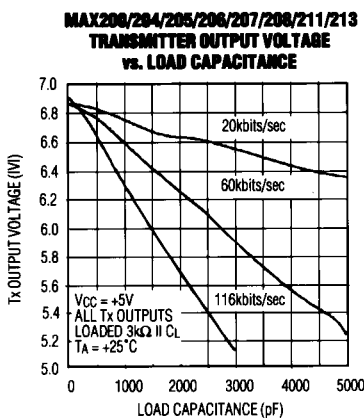

## +5V RS-232 Transceivers with 0.1μF External Capacitors

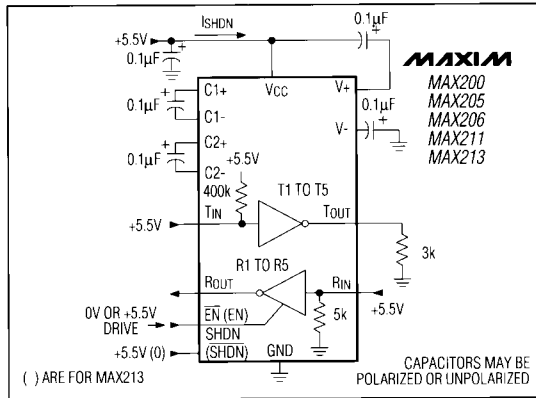

Figure 1. Shutdown Current Test Circuit

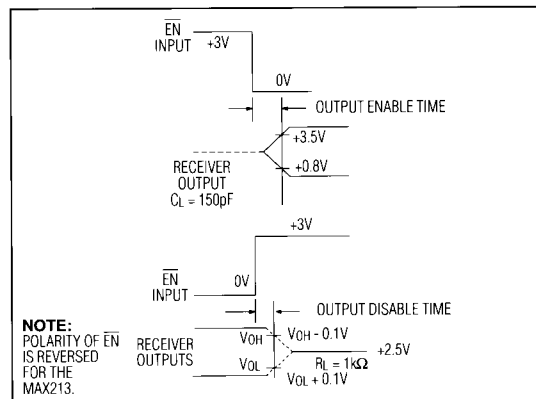

Figure 2. Receiver Output Enable and Disable Timing

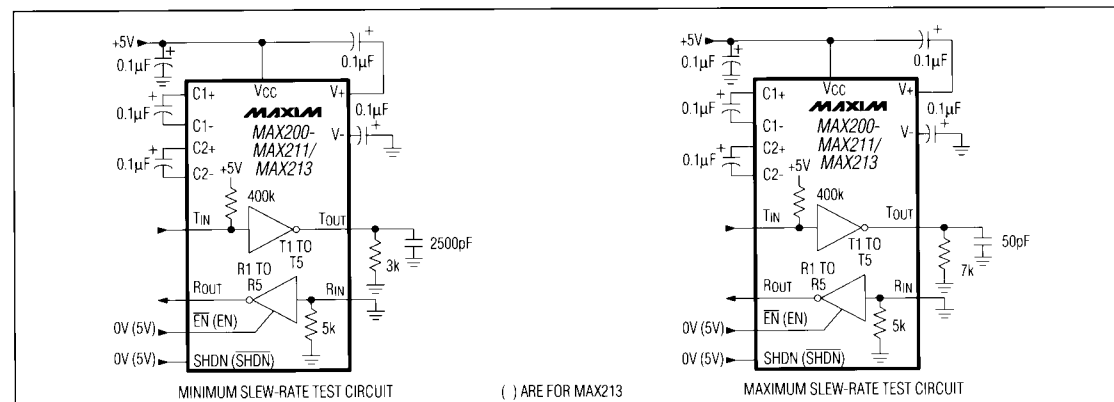

Figure 3. Transition Slew-Rate Test Circuit

### Detailed Description

The MAX200–MAX211/MAX213 consist of three sections: charge-pump voltage converters, drivers (transmitters), and receivers. Each section is described in detail below.

#### +5V to ±10V Dual Charge-Pump Voltage Converter

+5V to ±10V conversion is performed by two charge-pump voltage converters (Figure 4). The first uses capacitor C1 to double +5V to +10V, storing +10V on the V+ output filter capacitor, C3. The second charge-pump voltage converter uses capacitor C2 to invert +10V to -10V, storing -10V on the V- output filter capacitor, C4.

The MAX201 and MAX209 include only the V+ to V- charge-pump, and are intended for applications that have a VCC = +5V supply and a V+ supply in the +9V to +13.2V range.

In shutdown mode, V+ is internally connected to VCC by a 1kΩ pull-down resistor and V- is internally connected to ground by a 1kΩ pull-up resistor.

#### RS-232 Drivers

With VCC = 5V, the typical driver-output voltage swing is ±8V when loaded with a nominal 5kΩ RS-232 receiver. The output swing is guaranteed to meet the EIA/TIA-232E and V.28 specifications which call for ±5V minimum output levels under worst-case conditions. These include a minimum 3kΩ load, VCC = 4.5V, and maximum operating temperature. The open-circuit output voltage swing ranges from (V+ - 0.6V) to V-.

Input thresholds are both CMOS and TTL compatible. The inputs of unused drivers can be left unconnected, since 400kΩ pull-up resistors to VCC are included on-

## +5V RS-232 Transceivers with 0.1 $\mu$ F External Capacitors

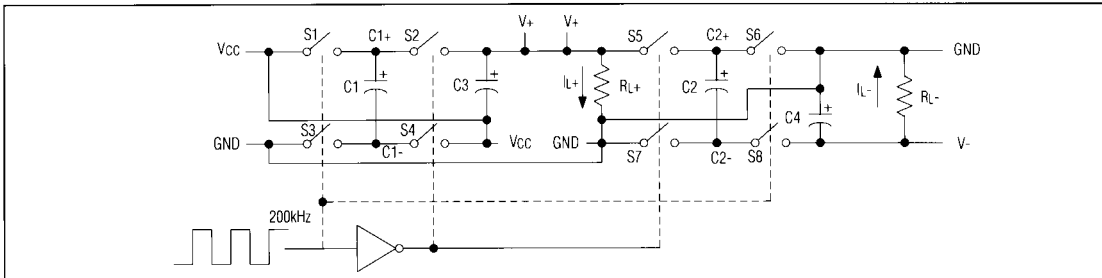

Figure 4. Dual Charge-Pump Diagram

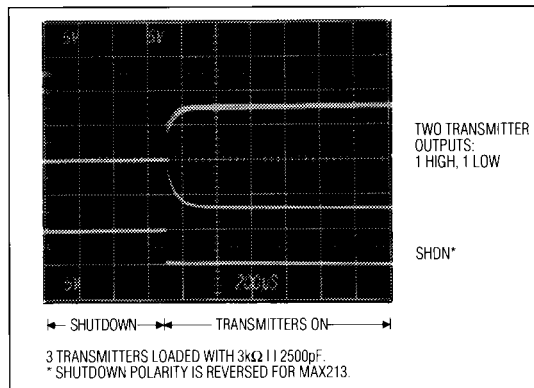

Figure 5. Transmitter Outputs When Exiting Shutdown

chip. Since all drivers invert, the pull-up resistors force the outputs of unused drivers low. The input pull-up resistors typically source 15 $\mu$ A; therefore, the driver inputs should be driven high or open circuited to minimize power-supply current in shutdown mode.

When in low-power shutdown mode, the driver outputs are turned off and their leakage current is less than 1 $\mu$ A, even if the transmitter output is backdriven between 0V and (VCC + 6V). Below -0.5V, the transmitter output is diode clamped to ground with a 1k $\Omega$  series impedance. The transmitter output is also zener clamped to approximately (VCC + 6V), with a 1k $\Omega$  series impedance.

### RS-232 Receivers

The receivers convert RS-232 signals to CMOS logic output levels. Receiver outputs are inverting, maintaining compatibility with driver outputs. The guaranteed receiver input thresholds of 0.8V and 2.4V are significantly tighter than the  $\pm 3.0$ V thresholds required by the EIA/TIA-232E specification. This allows receiver inputs to respond to TTL/CMOS logic levels, and improves noise margin for RS-232 levels.

The MAX200-MAX211/MAX213's guaranteed 0.8V threshold (0.6V in shutdown for the MAX213) ensures that receivers shorted to ground will have a logic 1 output. Also, the 5k $\Omega$  input resistance to ground ensures that a receiver with its input left open will also have a logic 1 output.

Receiver inputs have approximately 0.5V hysteresis. This provides clean output transitions, even with slow rise and fall time input signals with moderate amounts of noise and ringing. In shutdown, the MAX213 receivers R4 and R5 have no hysteresis.

### Shutdown and Enable Control

In shutdown mode, the MAX200/MAX205/MAX206/MAX211/MAX213 charge pumps are turned off, V+ is pulled down to VCC, V- is pulled to ground, and the transmitter outputs are disabled. This reduces supply current typically to 1 $\mu$ A (15 $\mu$ A for the MAX213). The time required to exit shutdown is 1ms, as shown in Figure 5.

All receivers except R4 and R5 on the MAX213 are put into a high-impedance state in shutdown mode. The MAX213's R4 and R5 receivers still function in shutdown mode. These two receivers are useful for monitoring external activity while maintaining minimal power consumption.

## +5V RS-232 Transceivers with 0.1 $\mu$ F External Capacitors

**MAX200-MAX211/MAX213**

The enable control is used to put the receiver outputs into a high-impedance state, so that the receivers can be connected directly to a three-state bus. It has no effect on the RS-232 drivers or on the charge pumps.

### MAX213 Receiver Operation in Shutdown

During normal operation, the MAX213's receiver propagation delay is typically 1 $\mu$ s. When entering shutdown with receivers active, R4 and R5 are not valid until 80 $\mu$ s

after  $\overline{\text{SHDN}}$  is driven low. In shutdown mode, propagation delays increase to 4 $\mu$ s for a high-to-low or a low-to-high transition.

When exiting shutdown, all receiver outputs are invalid until the charge pumps reach nominal values (<2ms when using 0.1 $\mu$ F capacitors).

**Table 1a. MAX200 Control Pin Configurations**

SHDN	OPERATION STATUS	TRANSMITTERS T1-T5
0	Normal Operation	All Active
1	Shutdown	All High-Z

**Table 1b. MAX205/MAX206/MAX211 Control Pin Configurations**

SHDN	$\overline{\text{EN}}$	OPERATION STATUS	TRANSMITTERS T1-T5	RECEIVERS R1-R5
0	0	Normal Operation	All Active	All Active
0	1	Normal Operation	All Active	All High-Z
1	0	Shutdown	All High-Z	All High-Z

**Table 1c. MAX213 Control Pin Configurations**

SHDN	EN	OPERATION STATUS	TRANSMITTERS	RECEIVERS	
			T1-T4	R1-R3	R4, R5
0	0	Shutdown	All High-Z	High-Z	High-Z
0	1	Shutdown	All High-Z	High-Z	Active*
1	0	Normal Operation	All Active	High-Z	High-Z
1	1	Normal Operation	All Active	Active	Active

\* Active = active with reduced performance.

## +5V RS-232 Transceivers with 0.1 $\mu$ F External Capacitors

### Applications Information

#### Capacitor Selection

The type of capacitor used is not critical for proper operation. Ceramic capacitors are suggested. To ensure proper RS-232 signal levels over temperature when using 0.1 $\mu$ F capacitors, make sure the capacitance value does not degrade excessively as the temperature varies. If in doubt, use capacitors with a larger nominal value. Also observe the capacitors' ESR (effective series resistance) value over temperature, since it will influence the amount of ripple on V+ and V-. To reduce the output impedance at V+ and V-, use larger capacitors (up to 10 $\mu$ F). If polarized capacitors are used, obey the polarities shown in Figure 1 and the Pin Configuration diagrams.

#### Driving Multiple Receivers

Each transmitter is designed to drive a single receiver. Transmitters can be paralleled to drive multiple receivers.

#### Driver Outputs when Exiting Shutdown

Figure 5 shows two driver outputs exiting shutdown. As they become active, the two driver outputs are shown going to opposite RS-232 levels (one driver input is high, the other is low). Each driver is loaded with 3k $\Omega$  in parallel with 2500pF. The driver outputs display no ringing or undesirable transients as they come out of shutdown.

#### Power-Supply Decoupling

In applications that are sensitive to power-supply noise, decouple VCC to ground with a capacitor of the same value as the charge-pump capacitors.

#### V+ and V- as Power Supplies

A small amount of power can be drawn from V+ and V-, although this will reduce noise margins.

#### Power Supplies for MAX201/MAX209

If at power-up, the V+ supply rises after the VCC supply, place a diode (e.g. 1N914) in series with the V+ supply.

Table 2. Summary of EIA/TIA-232E, V.28 Specifications

PARAMETER	CONDITION	EIA/TIA-232E, V.28 SPECIFICATION
Driver Output Voltage 0 Level 1 Level Output Level, Max	3k $\Omega$ to 7k $\Omega$ load 3k $\Omega$ to 7k $\Omega$ load No load	+5.0V to +15V -5.0V to -15V $\pm$ 25V
Data Rate	3k $\Omega$ $\leq$ R <sub>L</sub> $\leq$ 7k $\Omega$ , C <sub>L</sub> $\leq$ 2500pF	Up to 20kbits/sec
Receiver Input Voltage 0 Level 1 Level Input Level, Max		+3.0V to +15V -3.0V to -15V $\pm$ 25V
Instantaneous Slew Rate, Max	3k $\Omega$ $\leq$ R <sub>L</sub> $\leq$ 7k $\Omega$ , C <sub>L</sub> $\leq$ 2500pF	30V/ $\mu$ s
Driver Output Short-Circuit Current, Max		100mA
Transition Rate on Driver Output	V.28	1ms or 3% of the period
	EIA/TIA-232E	4% of the period
Driver Output Resistance	-2V < V <sub>OUT</sub> < +2V	300 $\Omega$



## +5V RS-232 Transceivers with 0.1μF External Capacitors

**MAX200-MAX211/MAX213**

**Table 3. DB9 Cable Connections Commonly Used for EIA/TIA-232E and V.24 Asynchronous Interfaces**

PIN	CONNECTION	
1	Received Line Signal Detector, sometimes called Carrier Detect (DCD)	Handshake from DCE
2	Receive Data (RD)	Data from DCE
3	Transmit Data (TD)	Data from DTE
4	Data Terminal Ready	Handshake from DTE
5	Signal Ground	Reference point for signals
6	Data Set Ready (DSR)	Handshake from DCE
7	Request to Send (RTS)	Handshake from DTE
8	Clear to Send (CTS)	Handshake from DCE
9	Ring Indicator	Handshake from DCE

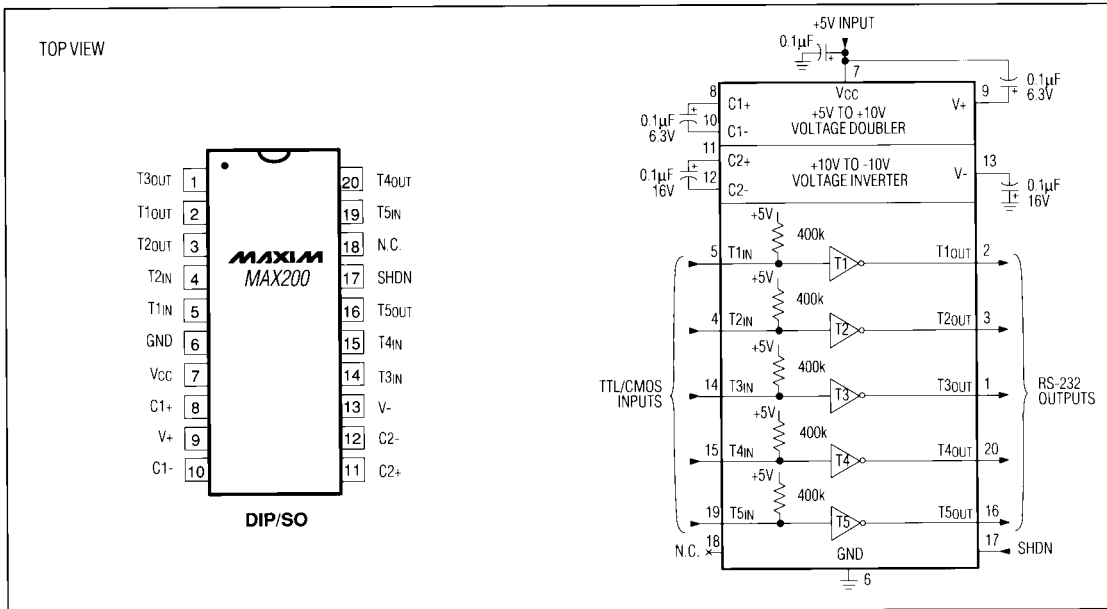

Figure 6. MAX200 Pin Configuration and Typical Operating Circuit

## +5V RS-232 Transceivers with 0.1μF External Capacitors

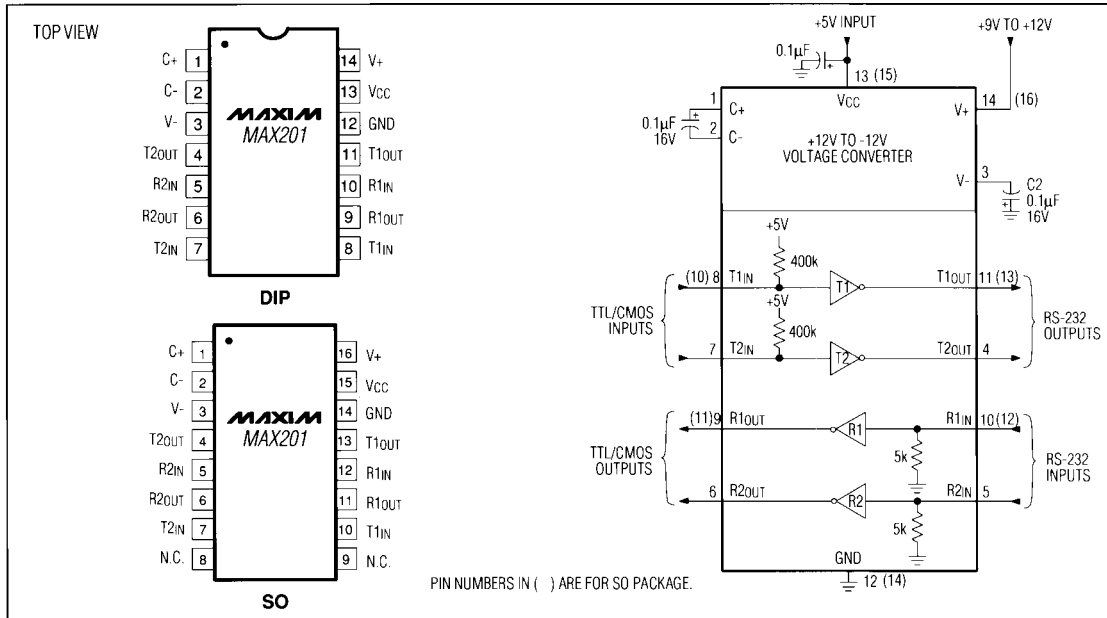

Figure 7. MAX201 Pin Configurations and Typical Operating Circuit

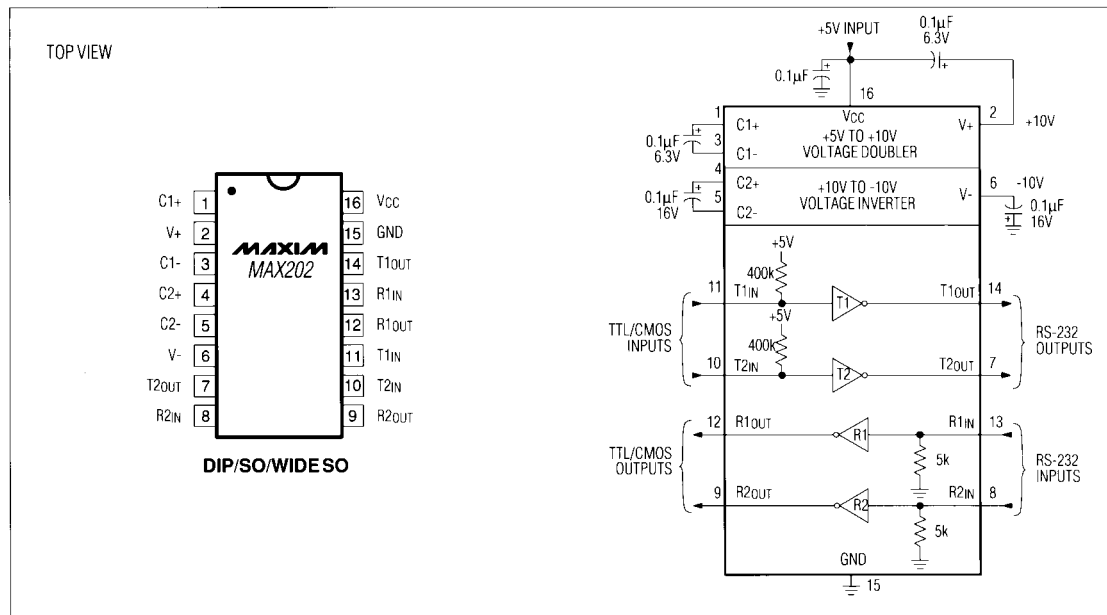

Figure 8. MAX202 Pin Configuration and Typical Operating Circuit

## +5V RS-232 Transceivers with 0.1μF External Capacitors

**MAX200-MAX211/MAX213**

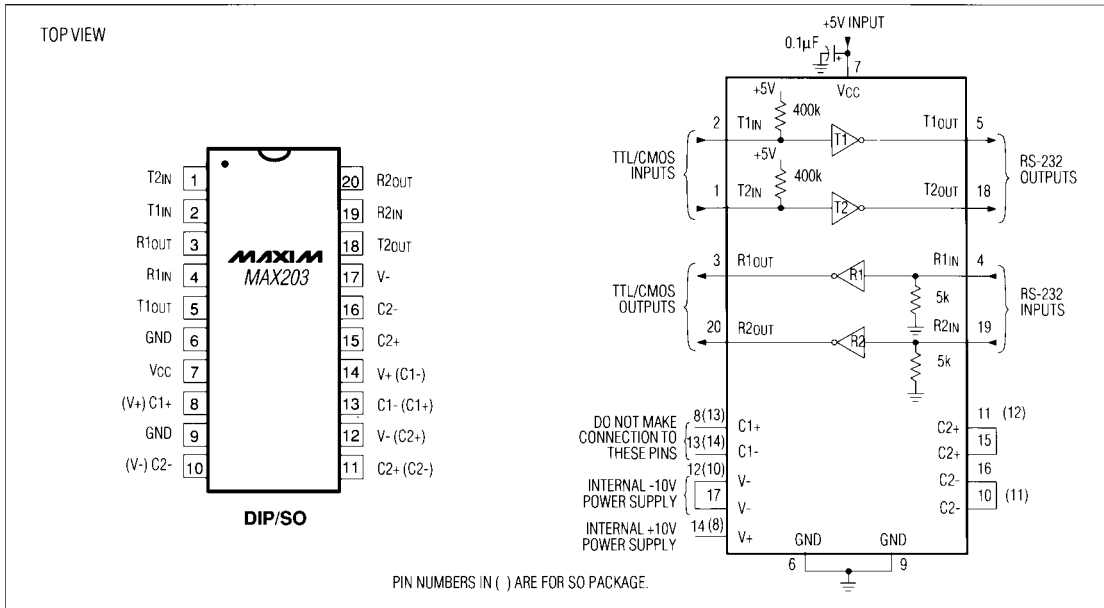

Figure 9. MAX203 Pin Configuration and Typical Operating Circuit

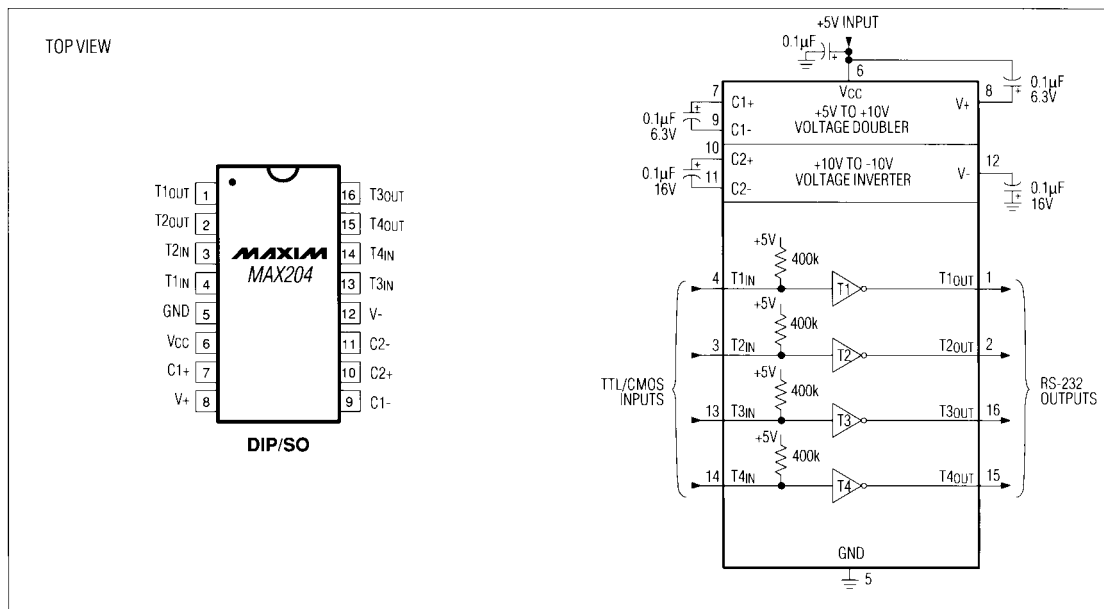
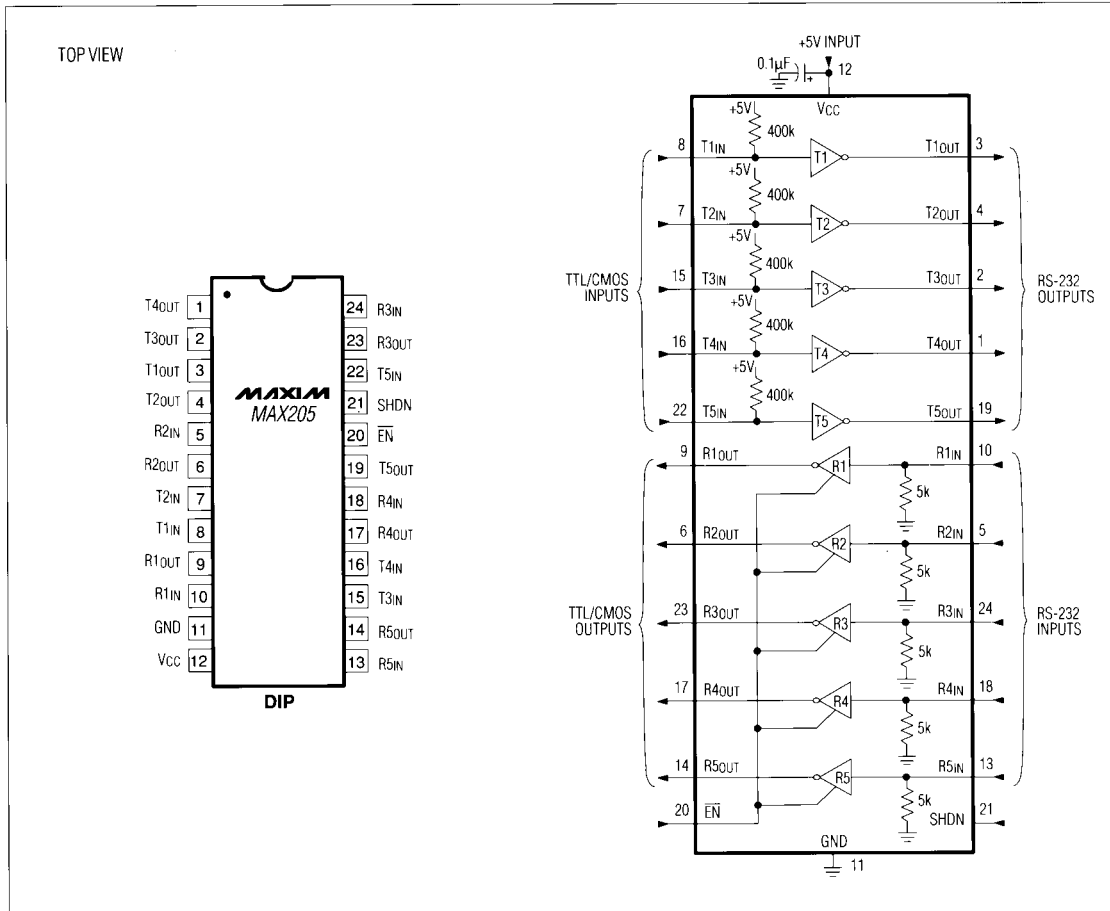

Figure 10. MAX204 Pin Configuration and Typical Operating Circuit

## **+5V RS-232 Transceivers with 0.1 $\mu$ F External Capacitors**



# +5V RS-232 Transceivers with 0.1 $\mu$ F External Capacitors

**MAX200-MAX211/MAX213**

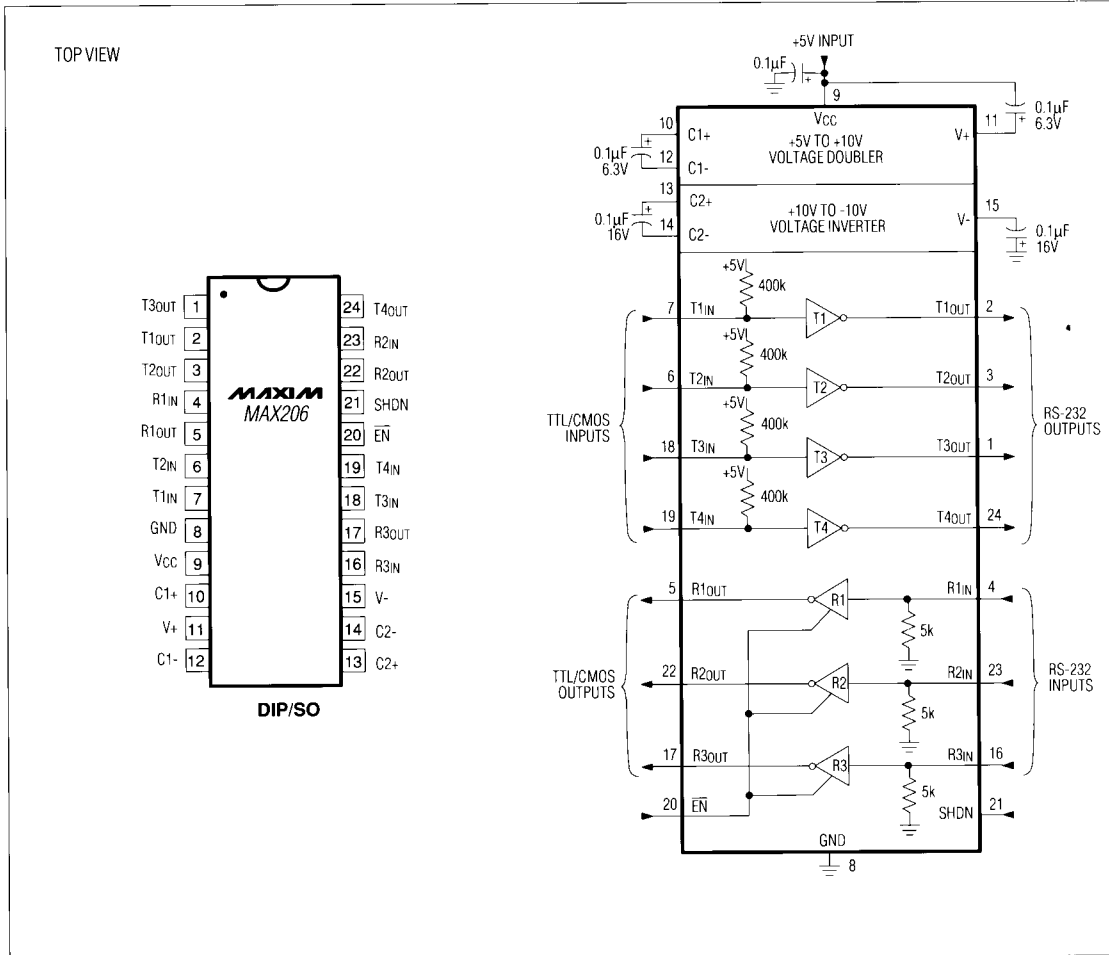

Figure 12. MAX206 Pin Configuration and Typical Operating Circuit

**MAX200-MAX211/MAX213**

**+5V RS-232 Transceivers with 0.1µF External Capacitors**

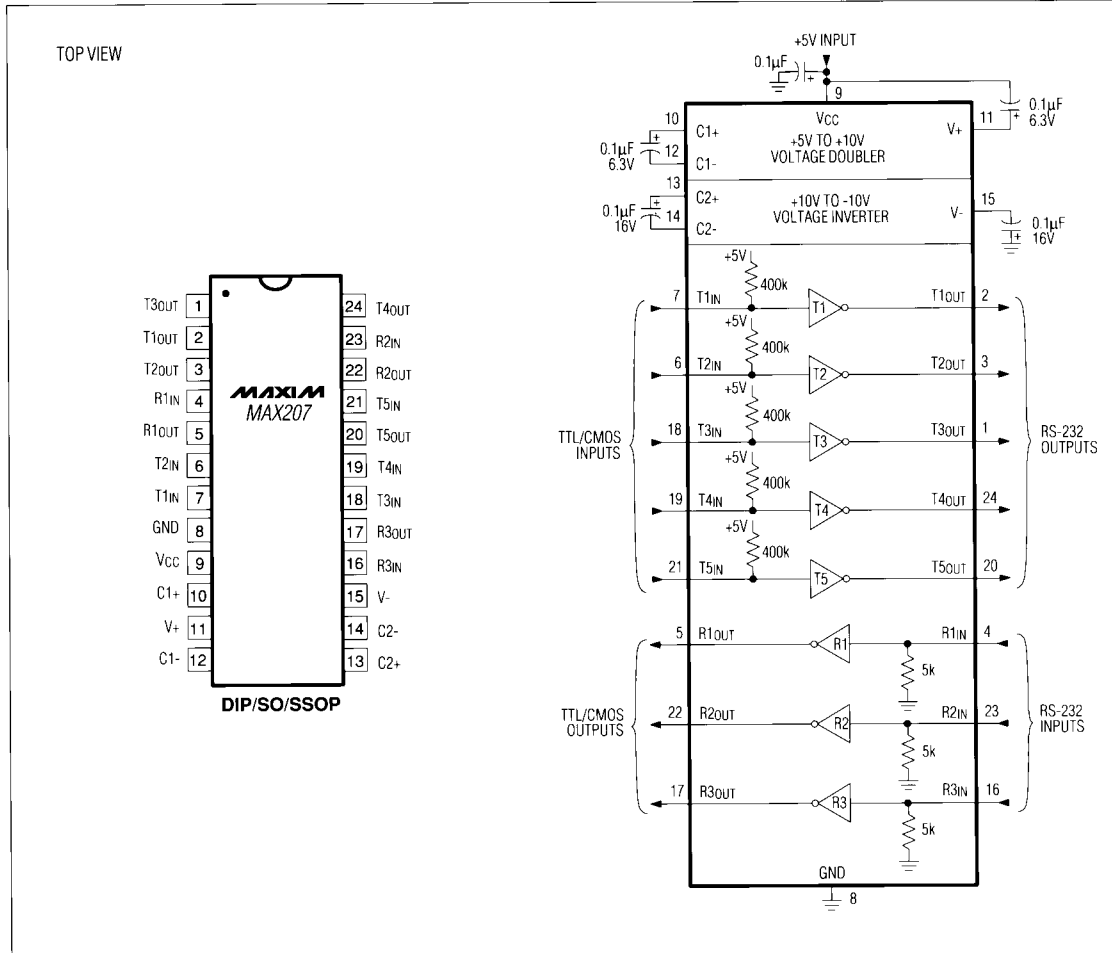

Figure 13. MAX207 Pin Configuration and Typical Operating Circuit

## +5V RS-232 Transceivers with 0.1μF External Capacitors

**MAX200-MAX211/MAX213**

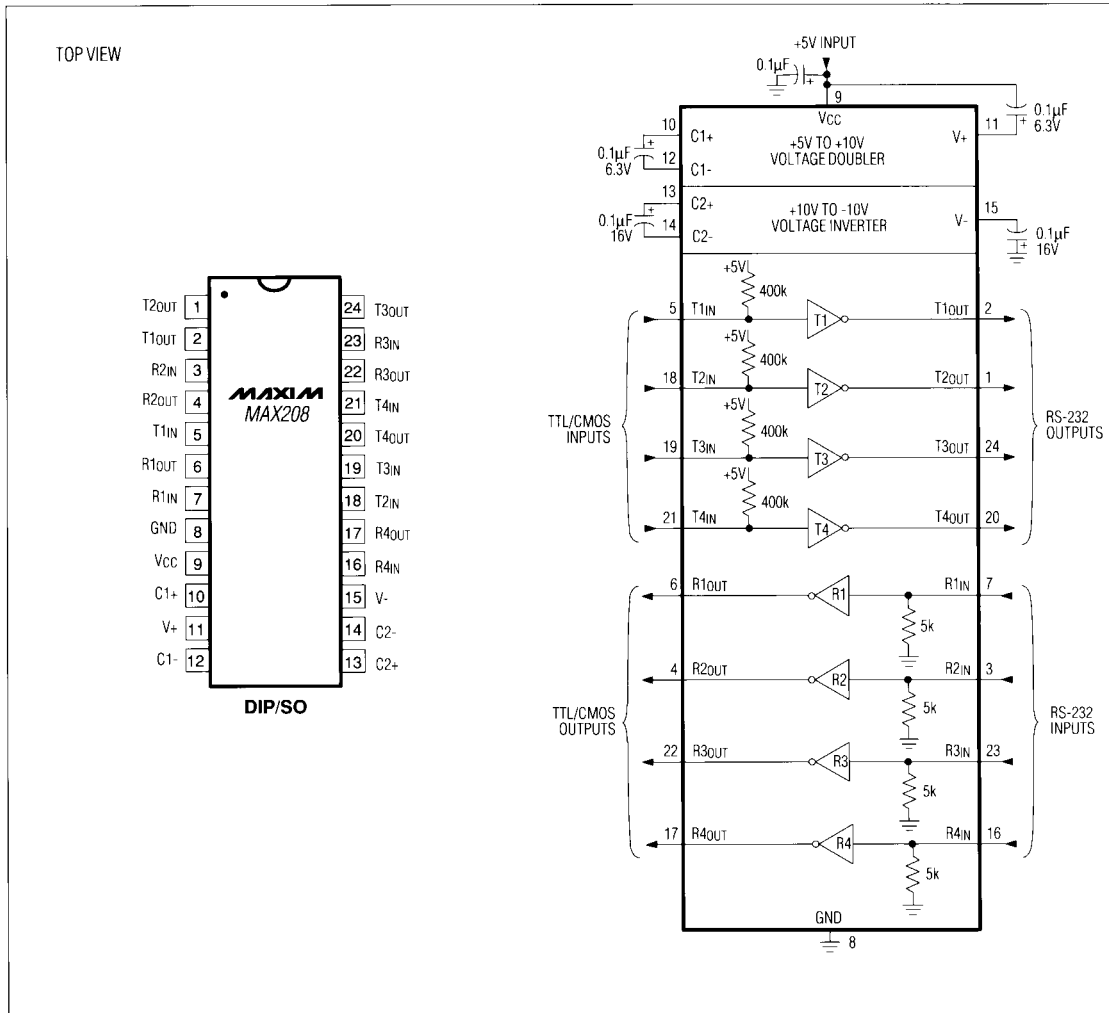

Figure 14. MAX208 Pin Configuration and Typical Operating Circuit

**MAX200-MAX211/MAX213**

**+5V RS-232 Transceivers  
with 0.1µF External Capacitors**

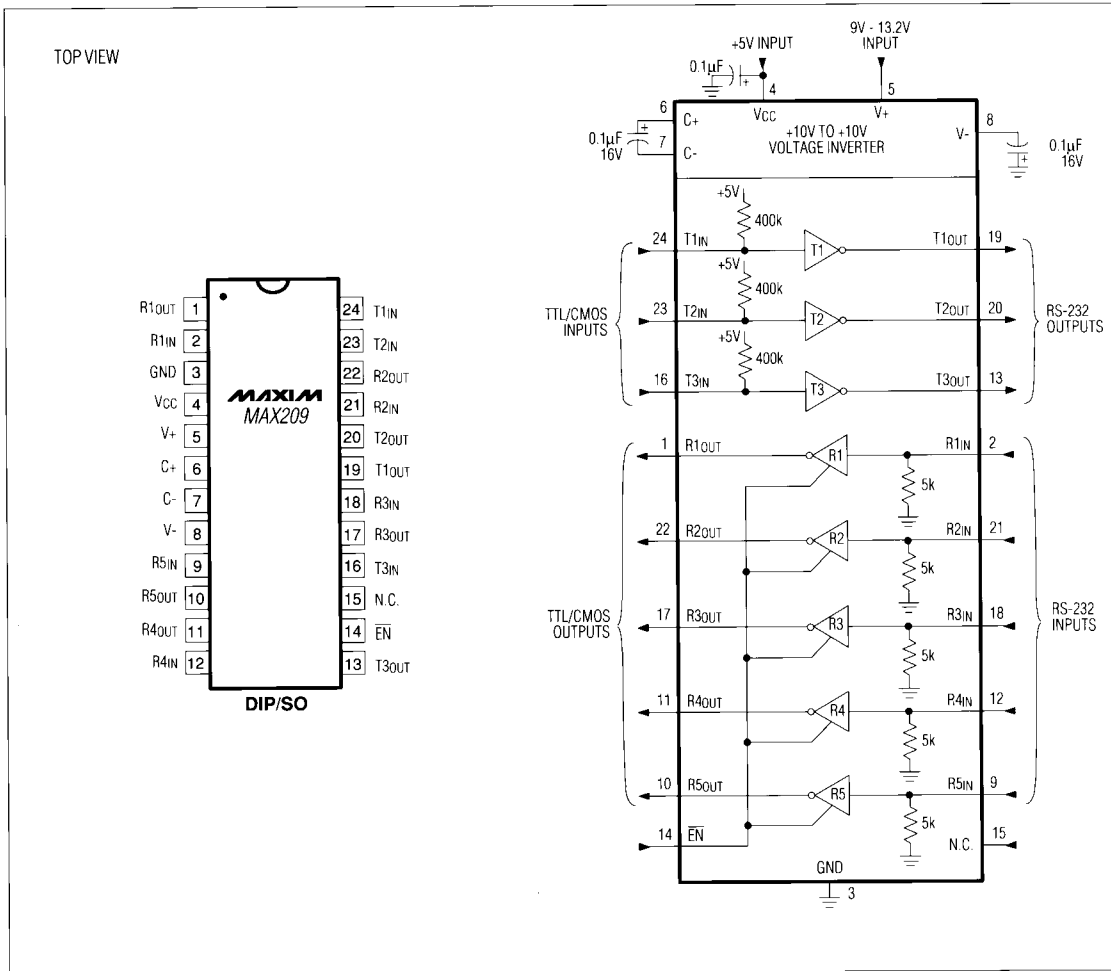

Figure 15. MAX209 Pin Configuration and Typical Operating Circuit



## +5V RS-232 Transceivers with 0.1 $\mu$ F External Capacitors

**MAX200-MAX211/MAX213**

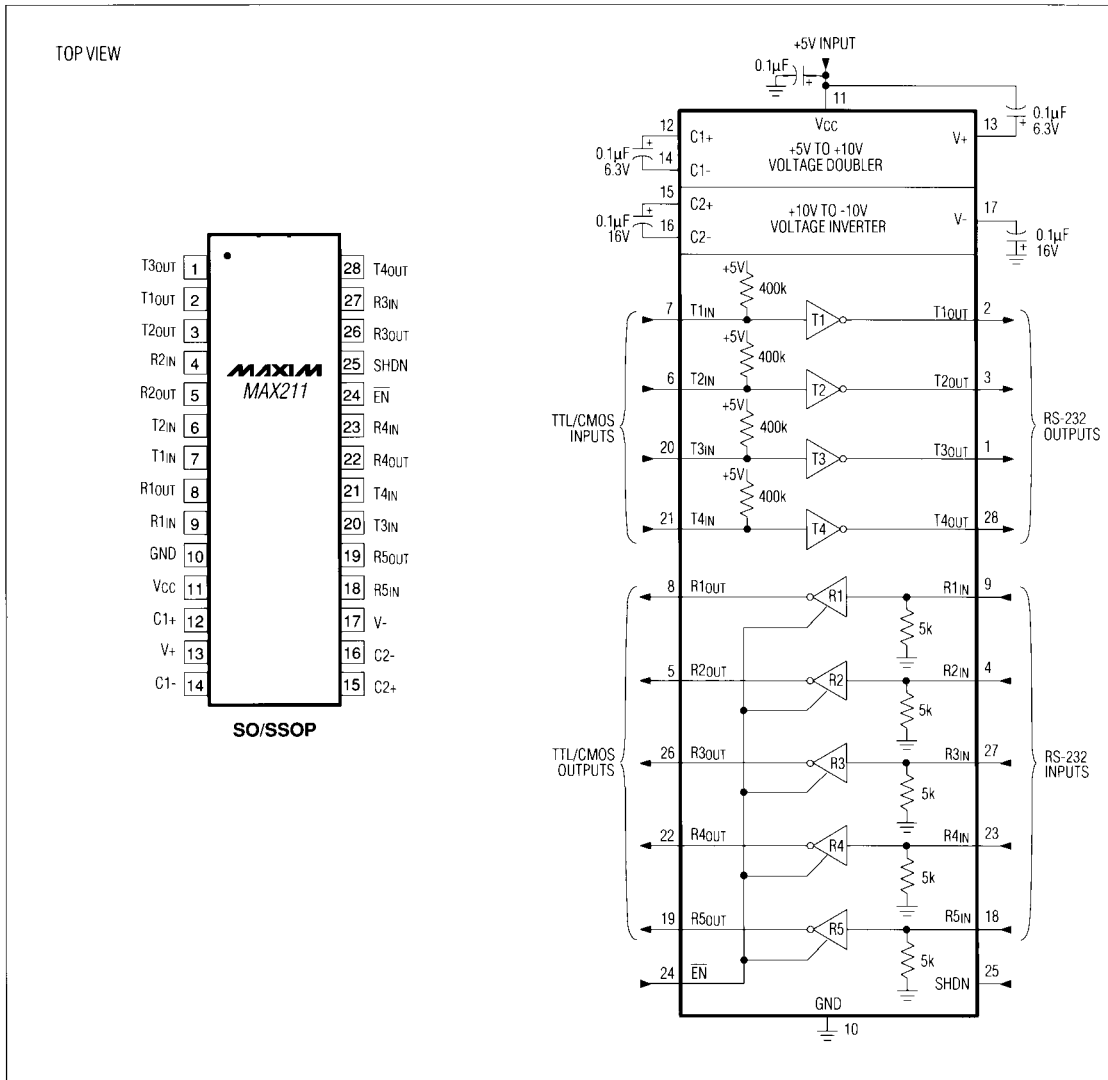

Figure 16. MAX211 Pin Configuration and Typical Operating Circuit

**MAX200-MAX211/MAX213**

**+5V RS-232 Transceivers with 0.1µF External Capacitors**

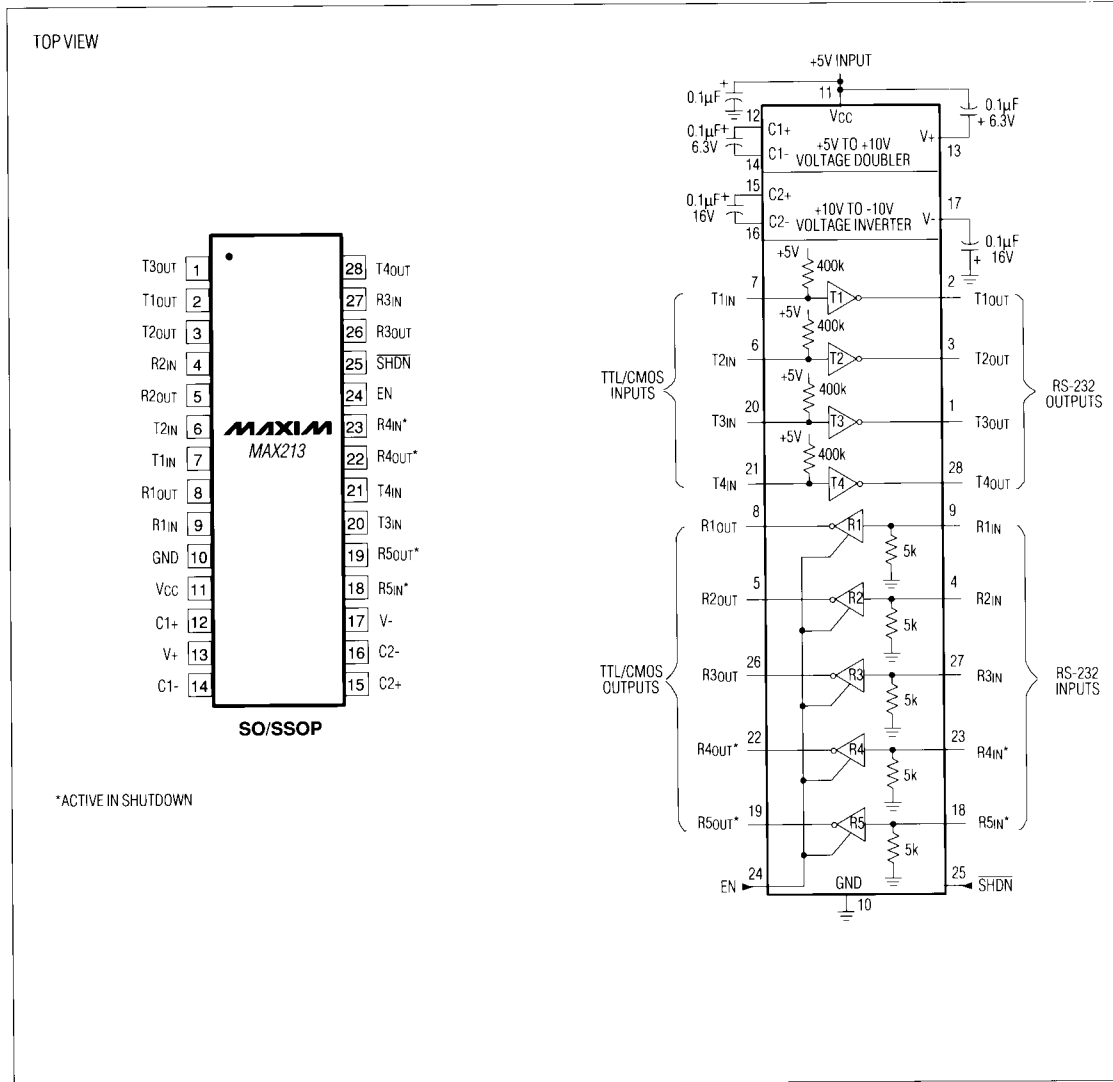

Figure 17. MAX213 Pin Configuration and Typical Operating Circuit

## +5V, RS-232 Transceivers with 0.1 $\mu$ F External Capacitors

### Ordering Information

MAX200-MAX211/MAX213

PART	TEMP RANGE	PIN-PACKAGE
<b>MAX200</b> CPP	0°C to +70°C	20 Plastic Dip
MAX200CWP	0°C to +70°C	20 Wide SO
MAX200EPP	-40°C to +85°C	20 Plastic Dip
MAX200EWP	-40°C to +85°C	20 Wide SO
<b>MAX201</b> CPD	0°C to +70°C	14 Plastic Dip
MAX201CWE	0°C to +70°C	16 Wide SO
MAX201C/D	0°C to +70°C	Dice*
MAX201EPD	-40°C to +85°C	14 Plastic Dip
MAX201EWE	-40°C to +85°C	16 Wide SO
<b>MAX202</b> CPE	0°C to +70°C	16 Plastic Dip
MAX202CSE	0°C to +70°C	16 Narrow SO
MAX202CWE	0°C to +70°C	16 Wide SO
MAX202C/D	0°C to +70°C	Dice*
MAX202EPE	-40°C to +85°C	16 Plastic Dip
MAX202ESE	-40°C to +85°C	16 Narrow SO
MAX202EWE	-40°C to +85°C	16 Wide SO
<b>MAX203</b> CPP	0°C to +70°C	20 Plastic Dip
MAX203CWP	0°C to +70°C	20 Wide SO
MAX203EPP	-40°C to +85°C	20 Plastic Dip
MAX203EWP	-40°C to +85°C	20 Wide SO
<b>MAX204</b> CPE	0°C to +70°C	16 Plastic Dip
MAX204CWE	0°C to +70°C	16 Wide SO
MAX204C/D	0°C to +70°C	Dice*
MAX204EPE	-40°C to +85°C	16 Plastic Dip
MAX204EWE	-40°C to +85°C	16 Wide SO
<b>MAX205</b> CPG	0°C to +70°C	24 Wide Plastic Dip
MAX205EPG	-40°C to +85°C	24 Wide Plastic Dip
<b>MAX206</b> CNG	0°C to +70°C	24 Narrow Plastic Dip
MAX206CWG	0°C to +70°C	24 Wide SO
MAX206CAG	0°C to +70°C	24 SSOP
MAX206ENG	-40°C to +85°C	24 Narrow Plastic Dip

PART	TEMP RANGE	PIN-PACKAGE
MAX206EWG	-40°C to +85°C	24 Wide SO
MAX206EAG	-40°C to +85°C	24 SSOP
<b>MAX207</b> CNG	0°C to +70°C	24 Narrow Plastic Dip
MAX207CWG	0°C to +70°C	24 Wide SO
MAX207CAG	0°C to +70°C	24 SSOP
MAX207ENG	-40°C to +85°C	24 Narrow Plastic Dip
MAX207EWG	-40°C to +85°C	24 Wide SO
MAX207EAG	-40°C to +85°C	24 SSOP
<b>MAX208</b> CNG	0°C to +70°C	24 Narrow Plastic Dip
MAX208CWG	0°C to +70°C	24 Wide SO
MAX208CAG	0°C to +70°C	24 SSOP
MAX208C/D	0°C to +70°C	Dice*
MAX208ENG	-40°C to +85°C	24 Narrow Plastic Dip
MAX208EWG	-40°C to +85°C	24 Wide SO
MAX208EAG	-40°C to +85°C	24 SSOP
<b>MAX209</b> CNG	0°C to +70°C	24 Narrow Plastic Dip
MAX209CWG	0°C to +70°C	24 Wide SO
MAX209C/D	0°C to +70°C	Dice*
MAX209ENG	-40°C to +85°C	24 Narrow Plastic Dip
MAX209EWG	-40°C to +85°C	24 Wide SO
<b>MAX211</b> CWI	0°C to +70°C	28 Wide SO
MAX211CAI	0°C to +70°C	28 SSOP
MAX211C/D	0°C to +70°C	Dice*
MAX211EWI	-40°C to +85°C	28 Wide SO
MAX211EAI	-40°C to +85°C	28 SSOP
<b>MAX213</b> CWI	0°C to +70°C	28 Wide SO
MAX213CAI	0°C to +70°C	28 SSOP
MAX213C/D	0°C to +70°C	Dice*
MAX213EWI	-40°C to +85°C	28 Wide SO
MAX213EAI	-40°C to +85°C	28 SSOP

\*Contact factory for dice specifications.

# +5V, RS-232 Transceivers with 0.1µF External Capacitors

## Package Information

(The package drawing(s) in this data sheet may not reflect the most current specifications. For the latest package outline information, go to [www.maxim-ic.com/packages](http://www.maxim-ic.com/packages).)

DIM	INCHES		MILLIMETERS	
	MIN	MAX	MIN	MAX
A	0.068	0.078	1.73	1.99
B	0.010	0.015	0.25	0.38
C	0.004	0.008	0.09	0.20
D	SEE VARIATIONS			
E	0.205	0.212	5.20	5.38
e	0.0256 BSC		0.65 BSC	
H	0.301	0.311	7.65	7.90
L	0.025	0.037	0.63	0.95
α	0°	8°	0°	8°

D	INCHES		MILLIMETERS		N
	MIN	MAX	MIN	MAX	
D	0.239	0.249	6.07	6.33	14L
D	0.239	0.249	6.07	6.33	16L
D	0.278	0.289	7.07	7.33	20L
D	0.317	0.328	8.07	8.33	24L
D	0.397	0.407	10.07	10.33	28L

**NOTES:**  
 1. D&E DO NOT INCLUDE MOLD FLASH.  
 2. MOLD FLASH OR PROTRUSIONS NOT TO EXCEED .15 MM (.006").  
 3. CONTROLLING DIMENSION: MILLIMETERS.  
 4. MEETS JEDEC MO150.  
 5. LEADS TO BE COPLANAR WITHIN 0.10 MM.

PROPRIETARY INFORMATION TITLE: PACKAGE OUTLINE, SSOP, 5.3 MM	
APPROVAL:	DOCUMENT CONTROL NO. 21-0056
REV. C	1/1

Maxim cannot assume responsibility for use of any circuitry other than circuitry entirely embodied in a Maxim product. No circuit patent licenses are implied. Maxim reserves the right to change the circuitry and specifications without notice at any time.

20 \_\_\_\_\_ Maxim Integrated Products, 120 San Gabriel Drive, Sunnyvale, CA 94086 408-737-7600