

SKM 400GB126D ...



SEMITRANS® 3

Trench IGBT Module

SKM 400GB126D

SKM 400GAL126D

Features

- Homogeneous Si
- Trench = Trenchgate technology
- V_{CEsat} with positive temperature coefficient
- High short circuit capability, self limiting to $6 \times I_C$

Typical Applications*

- AC inverter drives
- UPS
- Electronic welders

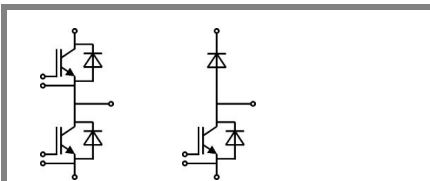

GB

GAL

Absolute Maximum Ratings		$T_C = 25\text{ °C}$, unless otherwise specified		
Symbol	Conditions	Values		Units
IGBT				
V_{CES}	$T_j = 25\text{ °C}$	1200		V
I_C	$T_j = 150\text{ °C}$	$T_{case} = 25\text{ °C}$	470	A
		$T_{case} = 80\text{ °C}$	330	A
I_{CRM}	$I_{CRM} = 2 \times I_{Cnom}$	600		A
V_{GES}		± 20		V
t_{psc}	$V_{CC} = 600\text{ V}; V_{GE} \leq 20\text{ V}; T_j = 125\text{ °C}$ $V_{CES} < 1200\text{ V}$	10		µs
Inverse Diode				
I_F	$T_j = 150\text{ °C}$	$T_{case} = 25\text{ °C}$	400	A
		$T_{case} = 80\text{ °C}$	270	A
I_{FRM}	$I_{FRM} = 2 \times I_{Fnom}$	600		A
I_{FSM}	$t_p = 10\text{ ms}; \sin.$	$T_j = 150\text{ °C}$	2200	A
Freewheeling Diode				
I_F	$T_j = 150\text{ °C}$	$T_{case} = 25\text{ °C}$	400	A
		$T_{case} = 80\text{ °C}$	270	A
I_{FRM}	$I_{FRM} = 2 \times I_{Fnom}$	600		A
I_{FSM}	$t_p = 10\text{ ms}; \sin.$	$T_j = 150\text{ °C}$	2200	A
Module				
$I_{t(RMS)}$		500		A
T_{vj}		- 40 ... + 150		°C
T_{stg}		- 40 ... + 125		°C
V_{isol}	AC, 1 min.	4000		V

Characteristics		$T_C = 25\text{ °C}$, unless otherwise specified			
Symbol	Conditions	min.	typ.	max.	Units
IGBT					
$V_{GE(th)}$	$V_{GE} = V_{CE}, I_C = 12\text{ mA}$	5	5,8	6,5	V
I_{CES}	$V_{GE} = 0\text{ V}, V_{CE} = V_{CES}$		0,15	0,45	mA
V_{CE0}		$T_j = 25\text{ °C}$	1	1,2	V
		$T_j = 125\text{ °C}$	0,9		V
r_{CE}	$V_{GE} = 15\text{ V}$	$T_j = 25\text{ °C}$	2,3	3,2	mΩ
		$T_j = 125\text{ °C}$	3,7		mΩ
$V_{CE(sat)}$	$I_{Cnom} = 300\text{ A}, V_{GE} = 15\text{ V}$	$T_j = 25\text{ °C}_{chiplev.}$	1,7	2,15	V
		$T_j = 125\text{ °C}_{chiplev.}$	2		V
C_{ies}	$V_{CE} = 25, V_{GE} = 0\text{ V}$	$f = 1\text{ MHz}$	23,1		nF
C_{oes}			1,9		nF
C_{res}			1,2		nF
Q_G	$V_{GE} = -8\text{ V} \dots +20\text{ V}$	2800		nC	
R_{Gint}	$T_j = \text{°C}$	2,5		Ω	
$t_{d(on)}$	$R_{Gon} = 2\text{ Ω}$	$V_{CC} = 600\text{ V}$ $I_C = 300\text{ A}$	330		ns
			$T_j = 125\text{ °C}$	50	ns
E_{on}	$R_{Goff} = 2\text{ Ω}$	$V_{GE} = \pm 15\text{ V}$	29		mJ
$t_{d(off)}$			650		ns
t_f			110		ns
E_{off}			48		mJ
$R_{th(j-c)}$	per IGBT			0,08	K/W

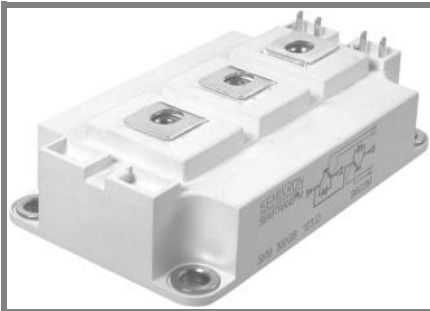

SEMITRANS® 3

Trench IGBT Module

SKM 400GB126D

SKM 400GAL126D

Features

- Homogeneous Si
- Trench = Trenchgate technology
- V_{CEsat} with positive temperature coefficient
- High short circuit capability, self limiting to $6 \times I_c$

Typical Applications*

- AC inverter drives
- UPS
- Electronic welders

Characteristics				min.	typ.	max.	Units
Symbol	Conditions						
Inverse Diode							
$V_F = V_{EC}$	$I_{Fnom} = 300 \text{ A}; V_{GE} = 0 \text{ V}$	$T_j = 25 \text{ }^\circ\text{C}_{chiplev.}$		1,6	1,8		V
		$T_j = 125 \text{ }^\circ\text{C}_{chiplev.}$		1,6	1,8		V
V_{F0}		$T_j = 25 \text{ }^\circ\text{C}$		1	1,1		V
		$T_j = 125 \text{ }^\circ\text{C}$		0,8	0,9		V
r_F		$T_j = 25 \text{ }^\circ\text{C}$		2	2,3		mΩ
		$T_j = 125 \text{ }^\circ\text{C}$		2,7	3		mΩ
I_{RRM}	$I_F = 300 \text{ A}$	$T_j = 125 \text{ }^\circ\text{C}$		390			A
Q_{rr}	$di/dt = 6300 \text{ A}/\mu\text{s}$			77			μC
E_{rr}	$V_{GE} = -15 \text{ V}; V_{CC} = 600 \text{ V}$			27			mJ
$R_{th(j-c)D}$	per diode				0,18		K/W
Freewheeling Diode							
$V_F = V_{EC}$	$I_{Fnom} = 300 \text{ A}; V_{GE} = 0 \text{ V}$	$T_j = 25 \text{ }^\circ\text{C}_{chiplev.}$		1,6	1,8		V
		$T_j = 125 \text{ }^\circ\text{C}_{chiplev.}$		1,6	1,8		V
V_{F0}		$T_j = 25 \text{ }^\circ\text{C}$		1	1,1		V
		$T_j = 125 \text{ }^\circ\text{C}$		0,8	0,9		V
r_F		$T_j = 25 \text{ }^\circ\text{C}$		2	2,3		V
		$T_j = 125 \text{ }^\circ\text{C}$		2,7	3		V
I_{RRM}	$I_F = 300 \text{ A}$	$T_j = 125 \text{ }^\circ\text{C}$		390			A
Q_{rr}	$di/dt = 6300 \text{ A}/\mu\text{s}$			77			μC
E_{rr}	$V_{GE} = -15 \text{ V}; V_{CC} = 600 \text{ V}$			27			mJ
$R_{th(j-c)D}$	per diode				0,18		K/W
Module							
L_{CE}				15	20		nH
$R_{CC'+EE'}$	res., terminal-chip	$T_{case} = 25 \text{ }^\circ\text{C}$		0,35			mΩ
		$T_{case} = 125 \text{ }^\circ\text{C}$		0,5			mΩ
$R_{th(c-s)}$	per module				0,038		K/W
M_s	to heat sink M6			3	5		Nm
M_t	to terminals M6			2,5	5		Nm
w					325		g

This is an electrostatic discharge sensitive device (ESDS), international standard IEC 60747-1, Chapter IX.

* The specifications of our components may not be considered as an assurance of component characteristics. Components have to be tested for the respective application. Adjustments may be necessary. The use of SEMIKRON products in life support appliances and systems is subject to prior specification and written approval by SEMIKRON. We therefore strongly recommend prior consultation of our personal.

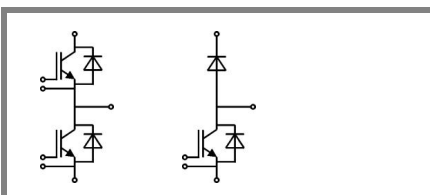

GB

GAL

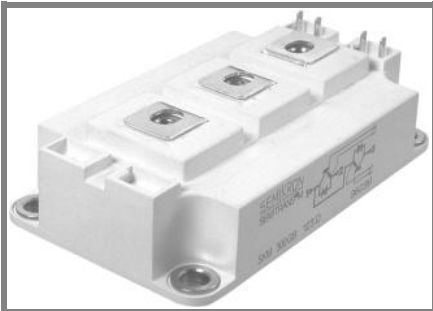

SEMITRANS® 3

Trench IGBT Module

SKM 400GB126D

SKM 400GAL126D

Features

- Homogeneous Si
- Trench = Trenchgate technology
- V_{CEsat} with positive temperature coefficient
- High short circuit capability, self limiting to $6 \times I_c$

Typical Applications*

- AC inverter drives
- UPS
- Electronic welders

Z_{th}		Conditions	Values	Units
$Z_{th(j-c)I}$				
$R_{\theta j-c}$		$i = 1$	55	mk/W
$R_{\theta j-c}$		$i = 2$	21	mk/W
$R_{\theta j-c}$		$i = 3$	3,6	mk/W
$R_{\theta j-c}$		$i = 4$	0,4	mk/W
$\tau_{\theta j-c}$		$i = 1$	0,0393	s
$\tau_{\theta j-c}$		$i = 2$	0,0171	s
$\tau_{\theta j-c}$		$i = 3$	0,002	s
$\tau_{\theta j-c}$		$i = 4$	0,0002	s
$Z_{th(j-c)D}$				
$R_{\theta j-c}$		$i = 1$	120	mk/W
$R_{\theta j-c}$		$i = 2$	48	mk/W
$R_{\theta j-c}$		$i = 3$	10	mk/W
$R_{\theta j-c}$		$i = 4$	2	mk/W
$\tau_{\theta j-c}$		$i = 1$	0,0262	s
$\tau_{\theta j-c}$		$i = 2$	0,0417	s
$\tau_{\theta j-c}$		$i = 3$	0,0012	s
$\tau_{\theta j-c}$		$i = 4$	0,001	s

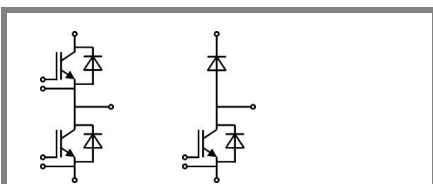

GB

GAL

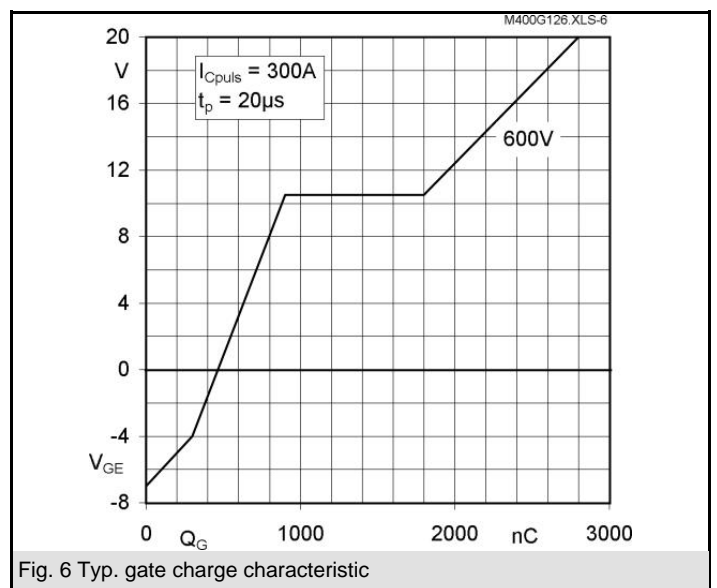
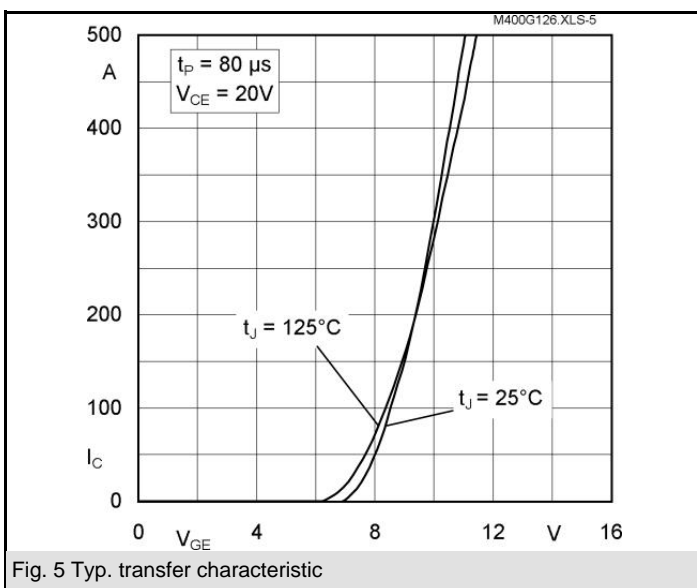
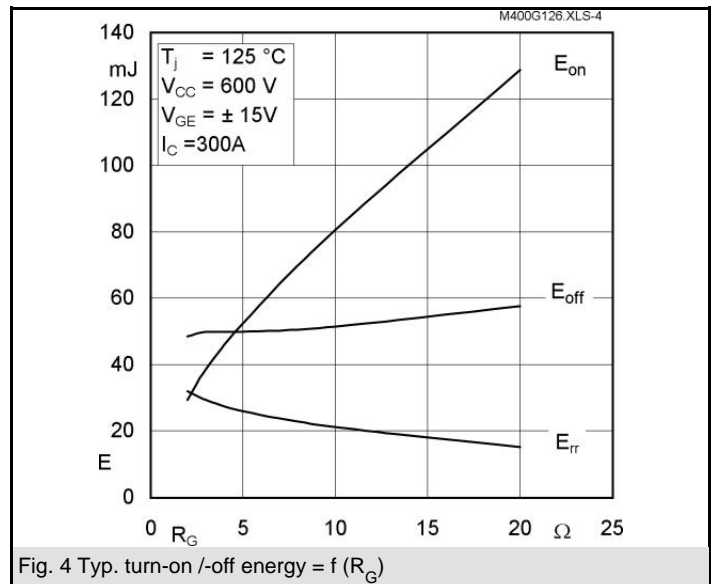
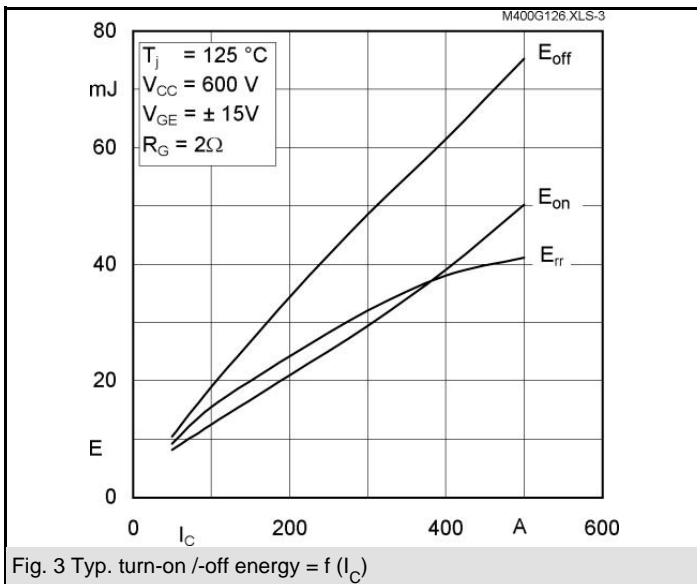
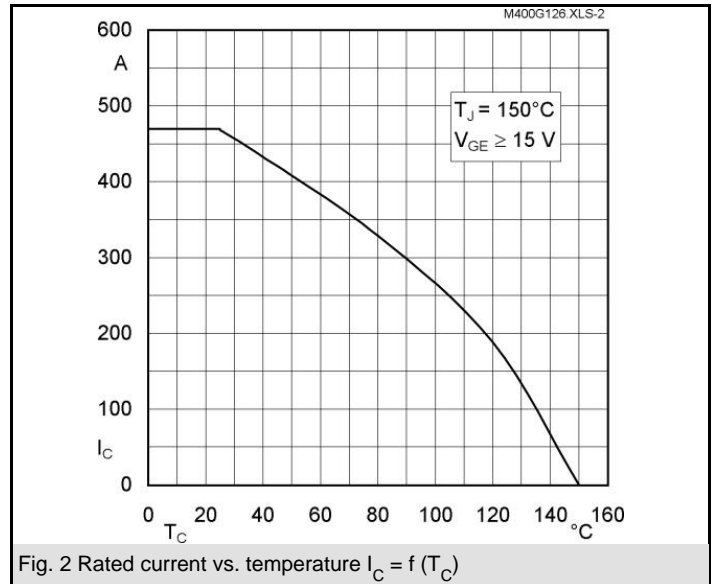
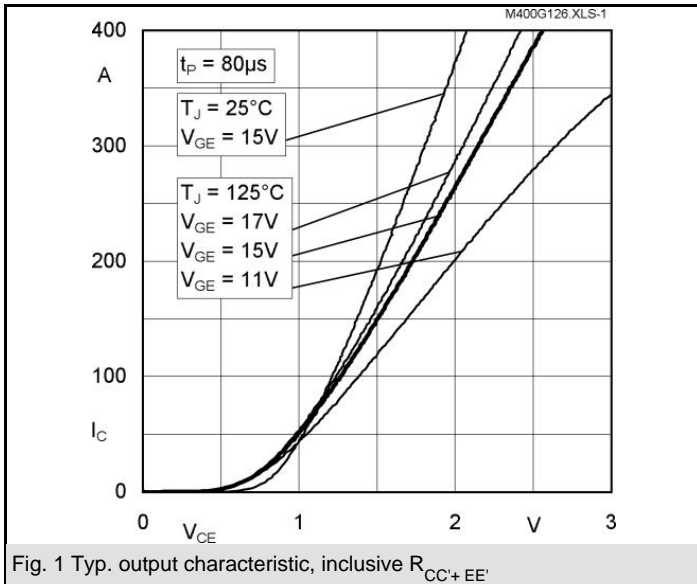

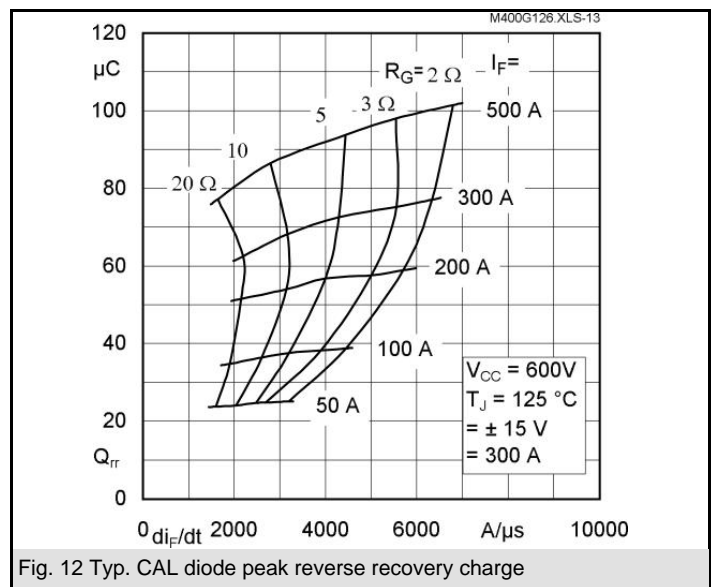
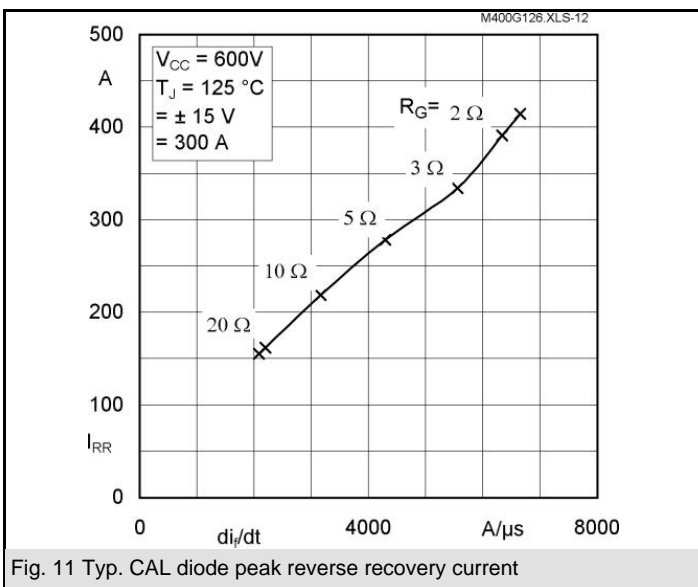
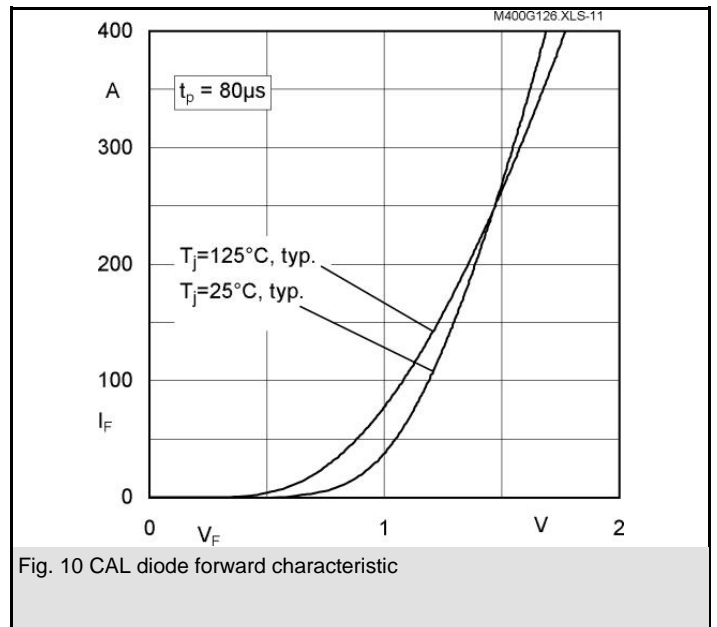
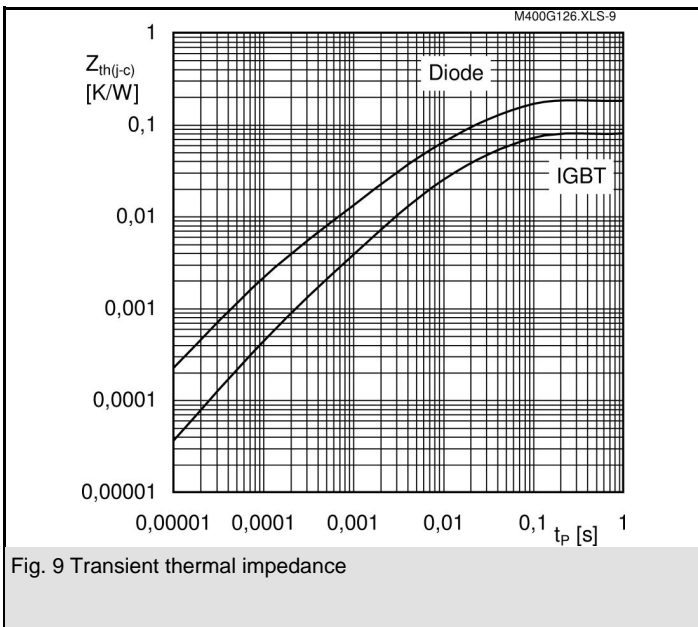
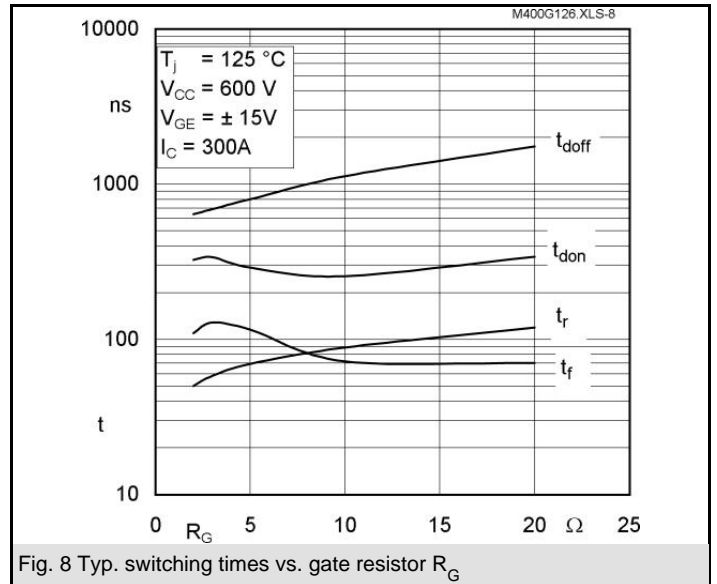
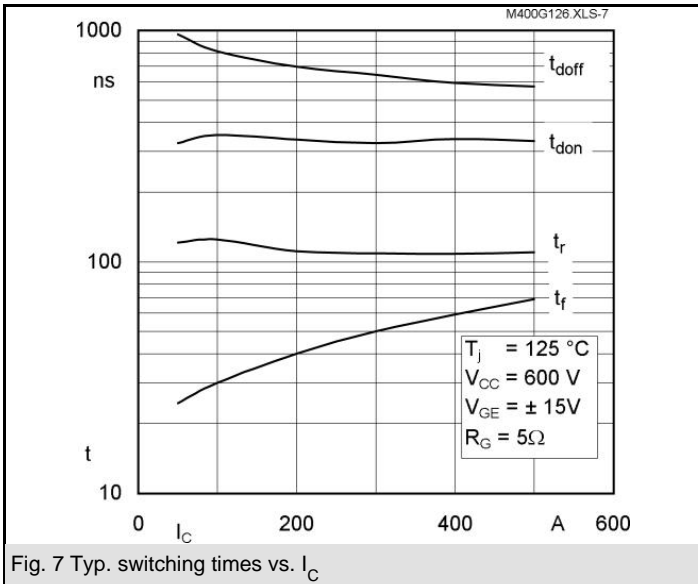

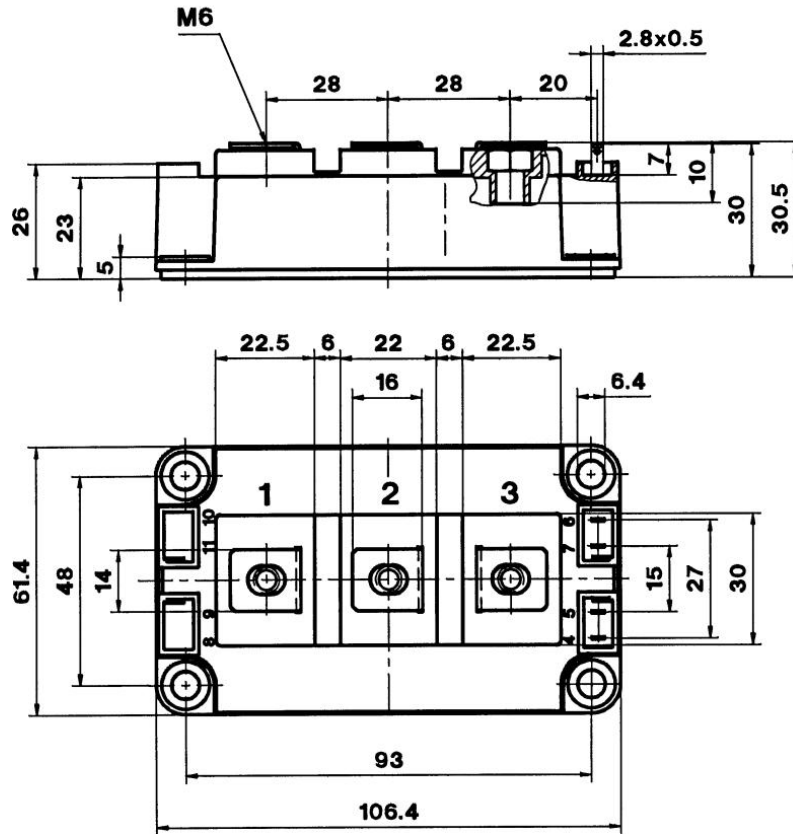

Case D 56

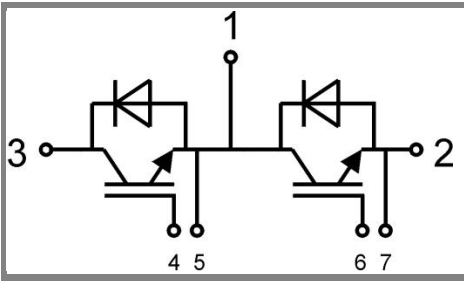

GB Case D 56

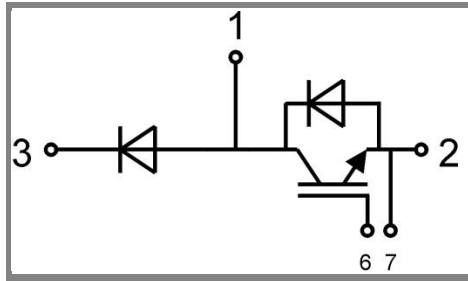

GAL Case D 57 (→ D 56)