

WDD20 SERIES

DC - DC CONVERTER
15 ~ 20W SINGLE & DUAL OUTPUT



FEATURES

- EFFICIENCY UP TO 89%
- 2:1 WIDE INPUT RANGE
- I/O ISOLATION
- INPUT Pi FILTER
- SHORT CIRCUIT PROTECTION
- HIGH PERFORMANCE
- 2 YEARS WARRANTY

MODEL LIST

| MODEL NO. | INPUT VOLTAGE | INPUT CURRENT (typ.) | OUTPUT WATTAGE | OUTPUT VOLTAGE | OUTPUT CURRENT | EFF. (min.) | EFF. (typ.) | CAPACITOR LOAD (max.) |
|-----------------------------|---------------|----------------------|----------------|----------------|----------------|-------------|-------------|-----------------------|
| Single Output Models | | | | | | | | |
| WDD20 - 03S1 | 9~18 VDC | 1.6 A | 15 WATTS | +3.3 VDC | 4500 mA | 77% | 80% | 7000 μ F |
| WDD20 - 05S1 | 9~18 VDC | 2.0 A | 20 WATTS | + 5 VDC | 4000 mA | 81% | 83% | 7000 μ F |
| WDD20 - 12S1 | 9~18 VDC | 2.0 A | 20 WATTS | + 12 VDC | 1670 mA | 84% | 86% | 1000 μ F |
| WDD20 - 15S1 | 9~18 VDC | 1.95 A | 20 WATTS | + 15 VDC | 1330 mA | 85% | 87% | 470 μ F |
| WDD20 - 03S2 | 18~36 VDC | 0.78 A | 15 WATTS | +3.3 VDC | 4500 mA | 78% | 80% | 7000 μ F |
| WDD20 - 05S2 | 18~36 VDC | 1.0 A | 20 WATTS | + 5 VDC | 4000 mA | 83% | 85% | 7000 μ F |
| WDD20 - 12S2 | 18~36 VDC | 1.0 A | 20 WATTS | + 12 VDC | 1670 mA | 84% | 86% | 1000 μ F |
| WDD20 - 15S2 | 18~36 VDC | 0.96 A | 20 WATTS | + 15 VDC | 1330 mA | 86% | 88% | 470 μ F |
| WDD20 - 03S3 | 36~72 VDC | 0.39 A | 15 WATTS | +3.3 VDC | 4500 mA | 78% | 80% | 7000 μ F |
| WDD20 - 05S3 | 36~72 VDC | 0.5 A | 20 WATTS | + 5 VDC | 4000 mA | 83% | 85% | 7000 μ F |
| WDD20 - 12S3 | 36~72 VDC | 0.49 A | 20 WATTS | + 12 VDC | 1670 mA | 85% | 87% | 1000 μ F |
| WDD20 - 15S3 | 36~72 VDC | 0.48 A | 20 WATTS | + 15 VDC | 1330 mA | 86% | 88% | 470 μ F |

| Dual Output Models | | | | | | | | |
|---------------------------|-----------|--------|----------|--------------|--------------|-----|-----|-------------------|
| WDD20 - 12D1 | 9~18 VDC | 2.0 A | 20 WATTS | \pm 12 VDC | \pm 830 mA | 83% | 85% | \pm 470 μ F |
| WDD20 - 15D1 | 9~18 VDC | 1.95 A | 20 WATTS | \pm 15 VDC | \pm 670 mA | 85% | 87% | \pm 470 μ F |
| WDD20 - 12D2 | 18~36 VDC | 0.97 A | 20 WATTS | \pm 12 VDC | \pm 830 mA | 85% | 87% | \pm 470 μ F |
| WDD20 - 15D2 | 18~36 VDC | 0.96 A | 20 WATTS | \pm 15 VDC | \pm 670 mA | 86% | 88% | \pm 470 μ F |
| WDD20 - 12D3 | 36~72 VDC | 0.48 A | 20 WATTS | \pm 12 VDC | \pm 830 mA | 85% | 87% | \pm 470 μ F |
| WDD20 - 15D3 | 36~72 VDC | 0.48 A | 20 WATTS | \pm 15 VDC | \pm 670 mA | 87% | 89% | \pm 470 μ F |

SPECIFICATION

All Specifications Typical At Nominal Line, Full Load, 25°C Unless Otherwise Noticed

| GENERAL | | | | | | |
|-----------------------|--------------------------|------|------|------|------------|--|
| Characteristics | Conditions | min. | typ. | max. | unit | |
| Switching frequency | Vi nom, Io nom | | 180 | | KHz | |
| Isolation voltage | Input - Output | 1500 | | | VDC | |
| Isolation resistance | Input - Output, @ 500VDC | 100 | | | M Ω | |
| Isolation capacitance | 100KHz / 1V | | | 1000 | PF | |

SPECIFICATION

All Specifications Typical At Nominal Line, Full Load, 25°C Unless Otherwise Noticed

| GENERAL | | | | | | |
|-------------------------|-----------------------------|-------------------------------|-------------------------|--------|--------|--------|
| Characteristics | Conditions | | min. | typ. | max. | unit |
| Ambient temperature | Vi nom, | 3.3V & 5V output models | -25 | | + 61 | °C |
| | Io nom | 12V, 15V & dual output models | -25 | | + 71 | °C |
| Case temperature | Operating at Vi nom, Io nom | | | | + 100 | °C |
| Derating | Vi nom | | See derating curve | | | |
| Storage temperature | Non operational | | -40 | | + 100 | °C |
| Relative humidity | Vi nom, Io nom | | 20 | | 95 | % RH |
| Temperature coefficient | Vi nom, Io min | | | | ± 0.02 | % / °C |
| Dimension | | | L50.8 x W40.64 x H10.16 | | | mm |
| MTBF | Bellcore issue 6@40°C, GB | | | 950000 | | Hours |
| Cooling | Free air convection | | | | | |

| INPUT SPECIFICATIONS | | | | | | |
|--------------------------|---------------------------|------------|------|------|------|------|
| Characteristics | Conditions | | min. | typ. | max. | unit |
| Input voltage range | Ta min ... Ta max, Io nom | | 9 | 12 | 18 | VDC |
| | | | 18 | 24 | 36 | VDC |
| | | | 36 | 48 | 72 | VDC |
| No load input current | Vi nom, Io = 0 | 12V models | | | 20 | mA |
| | | 24V models | | | 15 | mA |
| | | 48V models | | | 10 | mA |
| Input voltage w/o damage | Io nom | 12V models | | | 20 | VDC |
| | | 24V models | | | 40 | VDC |
| | | 48V models | | | 75 | VDC |
| Startup voltage | Io nom | 12V models | | 8.5 | | VDC |
| | | 24V models | | 16 | | VDC |
| | | 48V models | | 33 | | VDC |
| Input filter | Pi type | | | | | |

| OUTPUT SPECIFICATIONS | | | | | | |
|-------------------------------|---|----------------------------------|--|------|------|------|
| Characteristics | Conditions | | min. | typ. | max. | unit |
| Output voltage accuracy | Vi nom, Io nom | | | | ± 2 | % |
| Minimum load | Vi nom | single output models | 0 | | | % |
| | | dual output models (each output) | 10 | | | % |
| Line regulation | Io nom, Vi min ... Vi max | | | | ± 1 | % |
| Load regulation | Vi nom, Io 0 ... Io nom, single output models | | | | ± 2 | % |
| | Vi nom, Io min ... Io nom, dual output models | | | | ± 5 | % |
| Cross regulation (Dual model) | Aymmetrical load 10% - 100% FL | | | | ± 5 | % |
| Startup time | Vi nom, Io nom | | | | 30 | ms |
| Transient recovery time | Vi nom, I ~ 0.5 Io nom | | | | 500 | µs |
| Ripple & noise | Vi nom, Io nom, BW = 20MHz | 3.3V & 5V models | | | 100 | mV |
| | | 12V, 15V & dual | | | 150 | mV |
| Voltage trim range 1) | Vi nom | 3.3V model | | ± 5 | | % |
| | | 5V, 12V, 15V & dual | | ± 10 | | % |
| Efficiency | Vi nom, Io nom, Po / Pi | | Up to 89%, See model list and efficiency curve | | | |

NOTE 1 : Pls refer to Fig 1 & Table 1 for connection and resistance recommended.

| CONTROL AND PROTECTION | |
|----------------------------|---|
| Remote ON / OFF | ON : opened or 8 ~ 10VDC applied, reference to input GND OFF : -0.3 ~ 2VDC applied, reference to input GND |
| Input reversed | Shunt diode built in, external fuse recommended (12Vin : 3A, 24Vin : 1.5A, 48Vin : 1A) |
| Output short circuit | Current limited (Auto-recovery) |
| Rated over load protection | I 10%min.... I 40%max |

PHYSICAL CHARACTERISTICS

| | |
|------------------|--|
| Case size | 50.8 x 40.64 x 10.16 mm (2 x 1.6 x 0.4 inches) |
| Case material | Plastic base / Metal case |
| Weight | 60 g |
| Patting material | Epoxy |

MECHANISM & PIN CONFIGURATION

mm [inch]

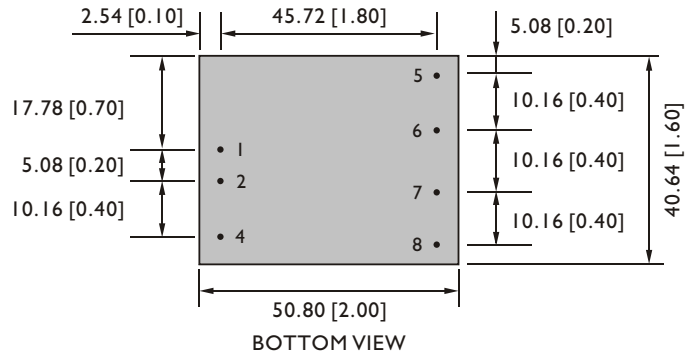
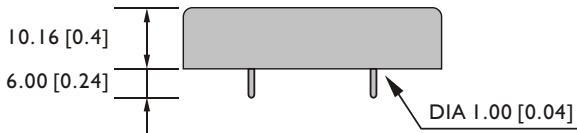

| GENERAL TOLERANCE | |
|----------------------------|-------------|
| 0.00[0.00] - 30.00[1.18] | ±0.30[0.01] |
| 30.00[1.18] - 120.00[4.72] | ±0.50[0.02] |

PIN ASSIGNMENT

GENERAL

| PIN NO. | 1 | 2 | 4 | 5 | 6 | 7 | 8 |
|---------|-----|-----|----------|--------|-----|-----|------|
| SINGLE | Vi+ | Vi- | ON / OFF | NO PIN | Vo+ | Vo- | Trim |
| DUAL | Vi+ | Vi- | ON / OFF | Vo+ | com | Vo- | Trim |

CIRCUIT SCHEMATIC

• Block diagram for WDD20 series with single output

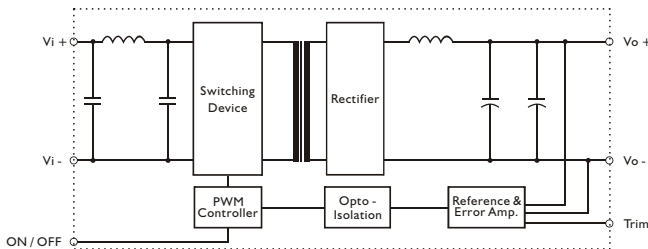

• Block diagram for WDD20 series with dual output

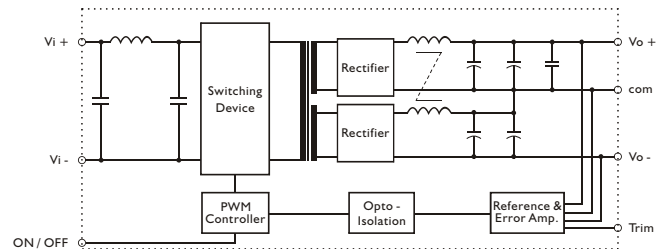

RECOMMENDED CIRCUIT

• Recommended filter for EN55022 Class B compliance

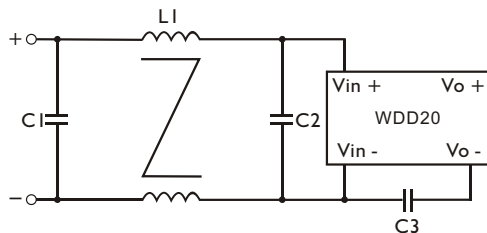

• The components used in the above figure, together with the manufacturer part numbers for these components, are as follows.

| | C1 | C2 | C3 | L1 |
|------------|--------------------|--------------------|----------------|--------------------|
| WDD20-XXX1 | 3.3 μF / 50V MLCC | 3.3 μF / 50V MLCC | InF / 2KV MLCC | 1.5mH Common Choke |
| WDD20-XXX2 | 1 μF / 50V MLCC | 1 μF / 50V MLCC | InF / 2KV MLCC | 1.5mH Common Choke |
| WDD20-XXX3 | 3.3 μF / 100V MLCC | 3.3 μF / 100V MLCC | InF / 2KV MLCC | 3.5mH Common Choke |

• Recommended EN 55022 Class B filter circuit layout.

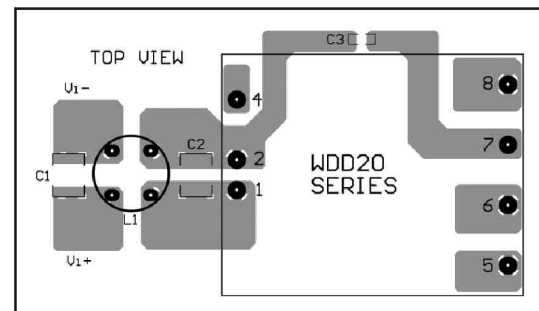

DERATING AND EFFICIENCY CURVE

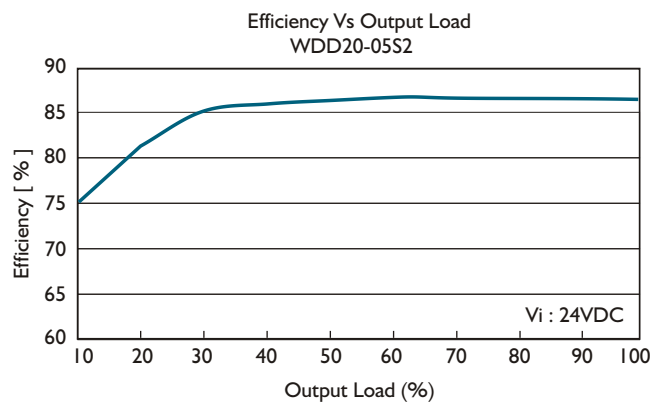
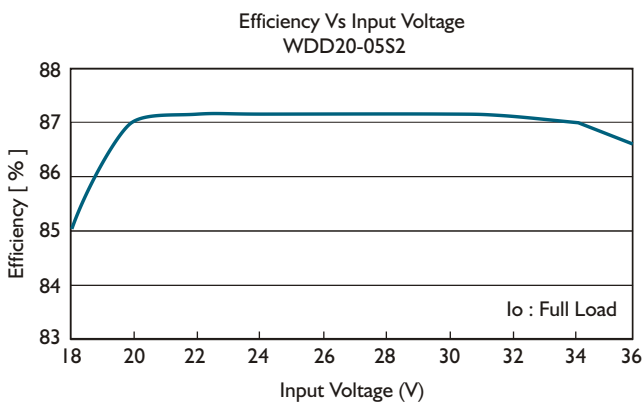
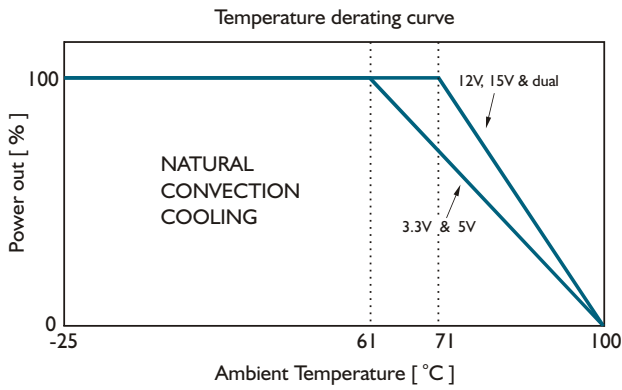
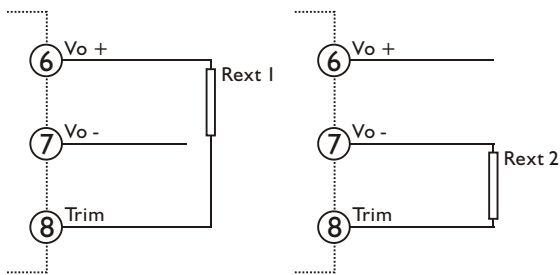

Fig. 1 Trim connection

(For Single output)



(For Dual output)

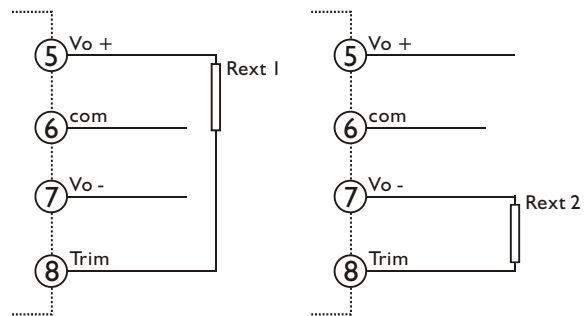

Table 1 Typical resistor values for various output voltage adjustment settings

| Type | Rext 1 | | Rext 2 | |
|------------|--------------|-------------|--------------|-------------|
| | Vo nom -2.5% | Vo nom -5% | Vo nom +2.5% | Vo nom +5% |
| WDD20-03SX | 1KΩ | 0Ω | 10KΩ | 4.7KΩ |
| Type | Vo nom -5% | Vo nom -10% | Vo nom +5% | Vo nom +10% |
| WDD20-05SX | 4.7KΩ | 100Ω | 4.7KΩ | 470Ω |
| WDD20-12SX | 30KΩ | 20KΩ | 10KΩ | 2KΩ |
| WDD20-15SX | 150KΩ | 56KΩ | 15KΩ | 3KΩ |
| WDD20-12DX | 120KΩ | 56KΩ | 12KΩ | 2KΩ |
| WDD20-15DX | 180KΩ | 75KΩ | 10KΩ | 1.2KΩ |