

RoHS Compliant

Features

- Distributed constant type LC filter. Prevents ringing caused by circuit impedance.
- Stable noise attenuation over wide frequency range.
- Small and low profile.
- KNA16xxxUA Series realize sharp attenuation characteristics over the frequency range from 470MHz for terrestrial digital TV to 2GHz for mobile phones.

Applications

- Data Lines for Mobile Phones (LCD Lines, Video Lines, Bus Lines)
- Bus Lines for Digital Equipment
- Terrestrial Digital TV Broadcasting

How to Order

KNA 16 300 C16 MA 7T S
 ① ② ③ ④ ⑤ ⑥ ⑦

① Series				
② Size Code	16	1608 (EIA: 0603)		
③ Cut off Frequency	100	100MHz	220	220MHz
	150	150MHz	300	300MHz
	170	170MHz	350	350MHz
	200	200MHz	390	390MHz
	210	210MHz		
④ Capacitance	C00	0pF	C18	18pF
	C09	9pF	C25	25pF
	C11	11pF	C33	33pF
	C12	12pF	C35	35pF
	C16	16pF	C45	45pF
⑤ Application	MA	Standard cellular phone		
	UA	Wide band (1 seg., DVB-H)		
⑥ Packaging	7T	T&R: 7000 pcs. (KNA16: Std.)		
⑦ Termination	S	Std.		

• Storage condition
 Temperature: -10 to +45°C
 Humidity: 45 to 75%RH

Specifications

Part Number	Cut off Frequency	Capacitance (+25/-20%)	Attenuation (Typical)	Rated Current	Rated Voltage	Operating Temperature
KNA16150C33MA7TS	150MHz	33pF	800 to 1000MHz (@25dB) 1000 to 2500MHz (@20dB)	35mA	25VDC	-25 to +85°C
KNA16200C25MA7TS	200MHz	25pF	800 to 1000MHz (@25dB) 1000 to 2500MHz (@20dB)	35mA	25VDC	
KNA16300C16MA7TS	300MHz	16pF	800 to 1000MHz (@25dB) 1000 to 2500MHz (@20dB)	35mA	25VDC	
KNA16390C11MA7TS	390MHz	11pF	800 to 1000MHz (@20dB) 1000 to 2500MHz (@15dB)	35mA	25VDC	
KNA16350C00MA7TS	350MHz	0pF	800 to 1000MHz (@15dB) 1000 to 2500MHz (@ 6dB)	35mA	25VDC	
KNA16100C45UA7TS	100MHz	45pF	470 to 1000MHz (@30dB) 1000 to 2500MHz (@25dB)	25mA	25VDC	-25 to +85°C
KNA16150C35UA7TS	150MHz	35pF	470 to 1000MHz (@25dB) 1000 to 2500MHz (@20dB)	25mA	25VDC	
KNA16170C25UA7TS	170MHz	25pF	470 to 1000MHz (@20dB) 1000 to 2500MHz (@20dB)	25mA	25VDC	
KNA16200C18UA7TS	200MHz	18pF	470 to 1000MHz (@20dB) 1000 to 2500MHz (@20dB)	25mA	25VDC	
KNA16210C12UA7TS	210MHz	12pF	470 to 1000MHz (@15dB) 1000 to 2500MHz (@15dB)	25mA	25VDC	
KNA16220C09UA7TS	220MHz	9pF	470 to 1000MHz (@10dB) 1000 to 2500MHz (@12dB)	25mA	25VDC	

Dimensions

(Unit: mm)

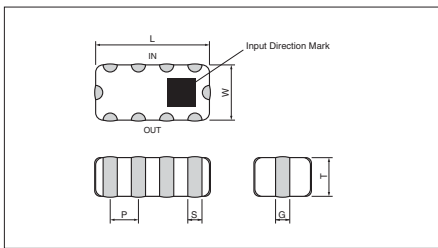

CODE	L	W	T
Dimensions	1.60±0.10	0.8±0.10	0.50±0.10
CODE	P	S	G
Dimensions	0.40	0.20±0.075	0.20±0.075

Attenuation Characteristics

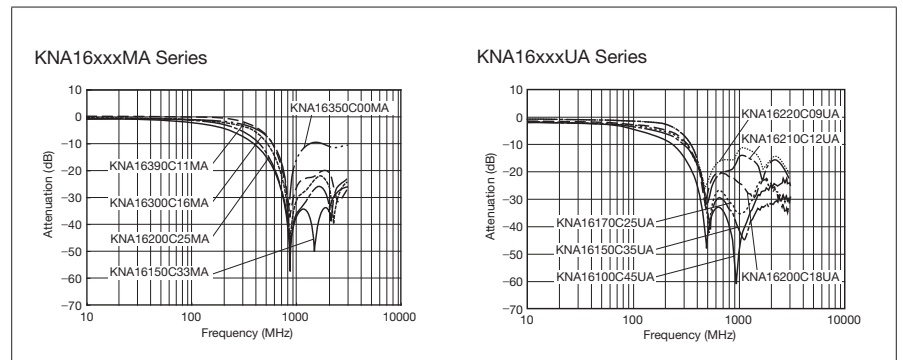

Recommended Land Pattern

(Unit: mm)

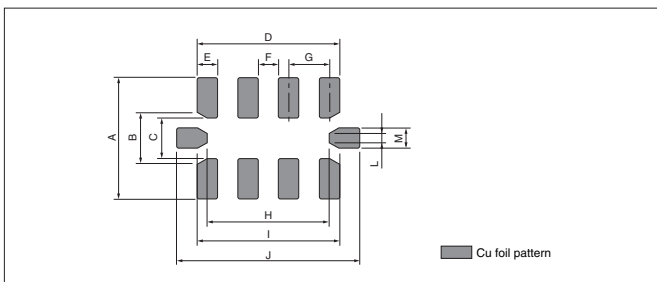

CODE	A	B	C	D	E	F	G	H	I	J	L	M
Dimensions	1.20	0.50	0.40	1.43	0.23	0.17	0.40	1.20	1.40	1.80	0.10	0.20

Packaging Specification

• Taping KNA16 : 7,000/ reel: STD. (Unit: mm)

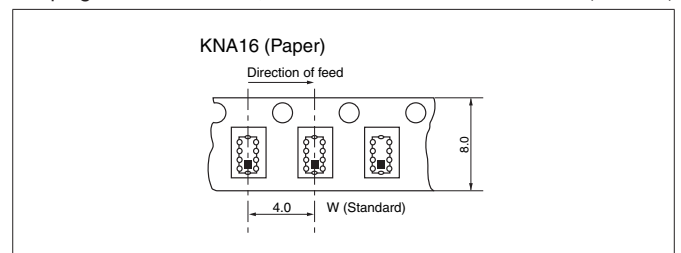

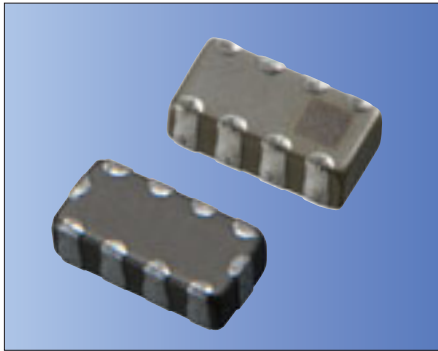

RoHS Compliant

Features

- Distributed constant type LC filter. Prevents ringing caused by circuit impedance.
- Stable noise attenuation over wide frequency range.
- Small and low profile.
- 0pF capacitance between Input-Output and GND makes the filter suitable for high speed data interface.

Applications

- Data Lines for Mobile Phones (High Speed Data Lines)
- High Speed Data Lines for Digital Equipment
- Terrestrial Digital TV Broadcasting

How to Order

KNA 16 350 C00 MD 7T S
 ① ② ③ ④ ⑤ ⑥ ⑦

① Series

② Size Code

16	1608 (EIA: 0603)
-----------	------------------

③ Cut off Frequency

230	230MHz	350	350MHz
550	550MHz		

④ Capacitance

C00	0pF	C05	5pF
------------	-----	------------	-----

⑤ Application

MD	For Mobile phone
UD	Wide band (1 seg., DVB-H)
MA	For Mobile phone (for High Speed data)

⑥ Packaging

7T	T&R: 7000 pcs. (KNA16: Std.)
-----------	------------------------------

⑦ Termination

S	Std.
----------	------

Specifications

Part Number	Cut off Frequency	Capacitance (+25/-20%)	Attenuation (Typical)	Rated Current	Rated Voltage	Operating Temperature
KNA16350C00MD7TS	350MHz	0pF	800 to 1000MHz (@15dB) 1000 to 2500MHz (@ 6dB)	35mA	25VDC	-25 to +85°C
KNA16230C00UD7TS	230MHz	0pF	470 to 1000MHz (@10dB) 1000 to 2500MHz (@ 6dB)	25mA	25VDC	
KNA16550C05MD7TS	550MHz	5pF	800 to 1000MHz (@10dB) 1000 to 2500MHz (@10dB)	35mA	25VDC	

• Storage condition
 Temperature: -10 to +45°C
 Humidity: 45 to 75%RH

Dimensions

(Unit: mm)

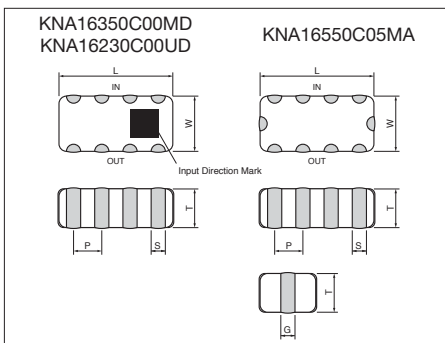

CODE	L	W	T
Dimensions	1.60±0.10	0.8±0.10	0.50±0.10
CODE	P	S	G
KNA16350C00MD KNA16230C00UD	0.40	0.20±0.075	—
KNA16550C05MA	0.40	0.20±0.075	0.20±0.075

Attenuation Characteristics

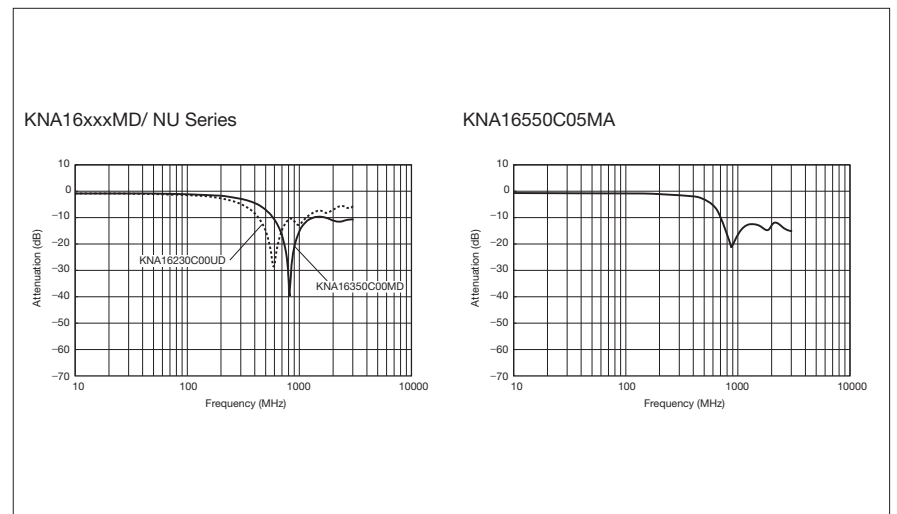

Recommended Land Pattern

(Unit: mm)

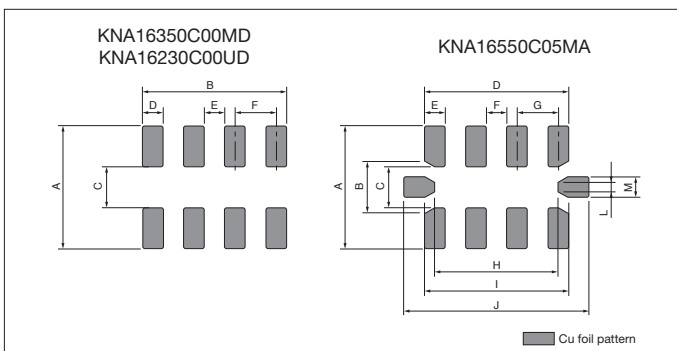

CODE	A	B	C	D	E	F						
KNA16350C00MD KNA16230C00UD	1.20	1.43	0.40	0.23	0.17	0.40						
CODE	A	B	C	D	E	F	G	H	I	J	L	M
KNA16550C05MA	1.20	0.50	0.40	1.43	0.23	0.17	0.40	1.20	1.40	1.80	0.10	0.20

Packaging Specification

- Taping KNA16 : 7,000/ reel: STD.

(Unit: mm)

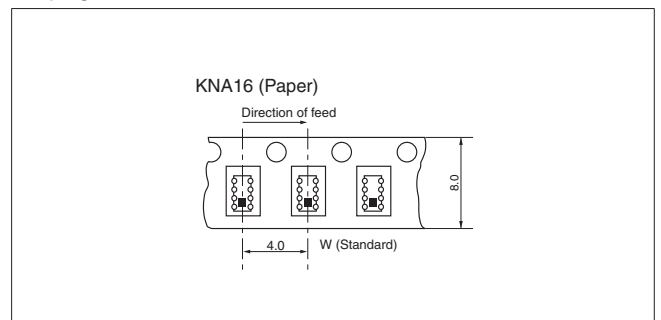

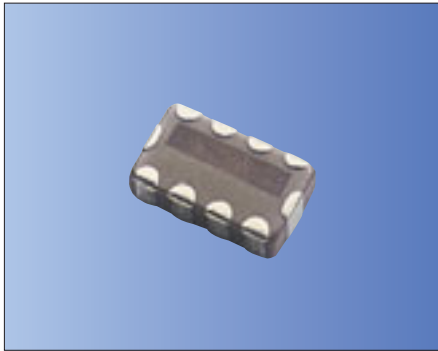

RoHS Compliant

Features

- Distributed constant type LC filter. Prevents ringing caused by circuit impedance.
- Stable noise attenuation over wide frequency range.
- Small and low profile.
- KNA21xxxUA Series realize sharp attenuation characteristics over the frequency range from 470MHz for terrestrial digital TV to 2GHz for mobile phones.

Applications

- Data Lines for Mobile Phones (LCD Lines, Video Lines, Bus Lines)
- Bus Lines for Digital Equipment
- Terrestrial Digital TV Broadcasting

How to Order

KNA 21 400 C18 MA 3T S
① ② ③ ④ ⑤ ⑥ ⑦

① Series

② Size Code

21	2012 (EIA: 0805)
-----------	------------------

③ Cut off Frequency

150	150MHz	250	250MHz
200	200MHz	300	300MHz
220	220MHz	400	400MHz

④ Capacitance

C15	15pF	C35	35pF
C18	18pF	C45	45pF
C25	25pF		

⑤ Application

MA	For Mobile phone
UA	Wide band (1 seg., DVB-H)

⑥ Packaging

3T	T&R: 3000 pcs. (KNA21: Std.)
-----------	------------------------------

⑦ Termination

S	Std.
----------	------

Specifications

Part Number	Cut off Frequency	Capacitance (+25/-20%)	Attenuation (Typical)	Rated Current	Rated Voltage	Operating Temperature
KNA21300C15MA3TS	300MHz	15pF	800 to 2000MHz (@20dB)	35mA	25VDC	-25 to +85°C
KNA21400C18MA3TS	400MHz	18pF	800 to 1000MHz (@20dB)	50mA	25VDC	
KNA21150C45UA3TS	150MHz	45pF	470 to 1000MHz (@35dB) 1000 to 2500MHz (@25dB)	25mA	25VDC	-25 to +85°C
KNA21200C35UA3TS	200MHz	35pF	470 to 1000MHz (@30dB) 1000 to 2500MHz (@20dB)	25mA	25VDC	
KNA21220C25UA3TS	220MHz	25pF	470 to 1000MHz (@25dB) 1000 to 2500MHz (@20dB)	25mA	25VDC	
KNA21250C18UA3TS	250MHz	18pF	470 to 1000MHz (@25dB) 1000 to 2500MHz (@20dB)	25mA	25VDC	

• Storage condition

Temperature: -10 to +45°C
Humidity: 45 to 75%RH

Dimensions

(Unit: mm)

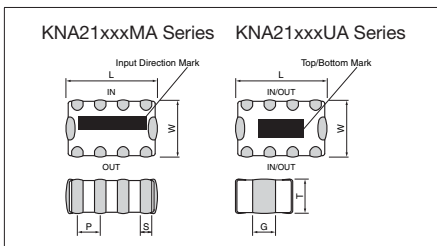

CODE	L	W	T
Dimensions	2.0±0.2	1.25±0.2	0.7±0.15
CODE	P	S	G
Dimensions	0.50	0.25±0.1	0.40±0.15

Attenuation Characteristics

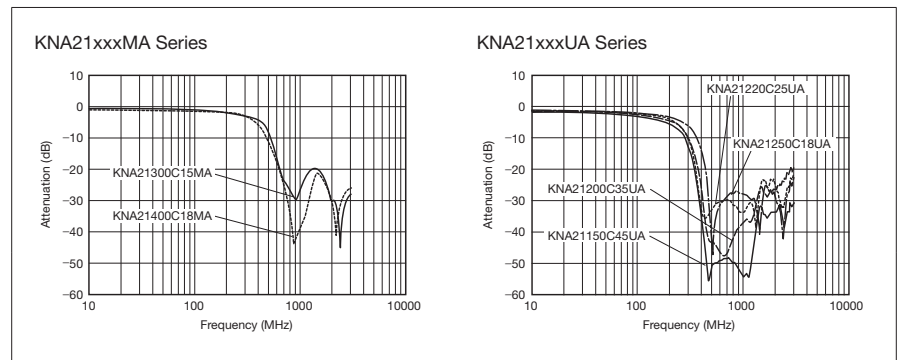

Recommended Land Pattern

(Unit: mm)

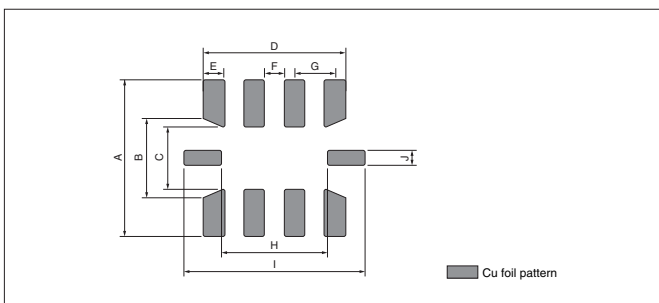

CODE	A	B	C	D	E	F	G	H	I	J
Dimensions	2.00	0.95	0.75	1.75	0.25	0.25	0.50	1.35	2.45	0.20

Packaging Specification

• Taping

KNA21 : 3,000/ reel: STD.

(Unit: mm)

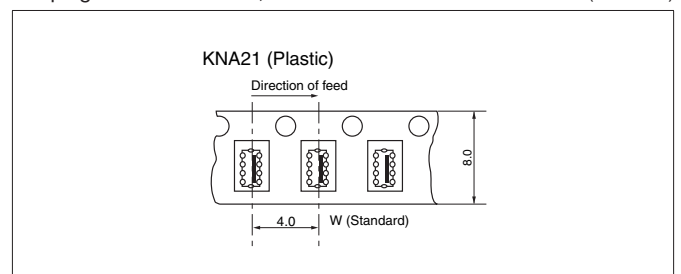

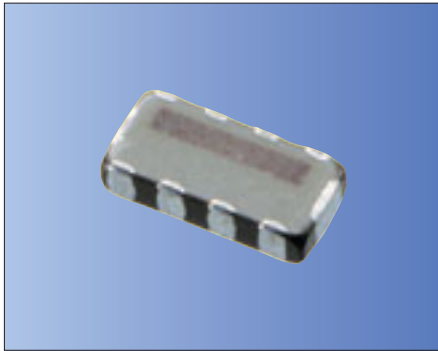

RoHS Compliant

Features

- Distributed constant type LC filter. Prevents ringing caused by circuit impedance.
- Stable noise attenuation over wide frequency range.
- Low profile (T=0.85mm max.) suitable for miniature electronic equipments.
- First class auto-placement

Applications

- PCs, Laser Printers, Cellular Phone, Clock Data Lines for LCD Display
- High Speed Video Signal Circuits and Interface Circuits
- High Speed Digital Circuits

How to Order

KNA 32 200 C35 DA 3T S
 ① ② ③ ④ ⑤ ⑥ ⑦

① Series

② Size Code

32	3216 (EIA: 1206)
-----------	------------------

③ Cut off Frequency

050	50MHz	150	150MHz
075	75MHz	200	200MHz
100	100MHz		

④ Capacitance

C35	35pF	C82	82pF
C45	45pF	C115	115pF
C65	65pF		

⑤ Application

DA	Digital Circuit in General
-----------	----------------------------

⑥ Packaging

3T	T&R: 3000 pcs. (Std.)
-----------	-----------------------

⑦ Termination

S	Std.
----------	------

Specifications

Part Number	Cut off Frequency	Capacitance (+25/ -20%)	Attenuation (Typical)	Rated Current	Rated Voltage	Operating Temperature
KNA32050C115DA3TS	50MHz	115pF	350 to 850MHz(@20dB)	100mA	25VDC	-25 to +85°C
KNA32075C82DA3TS	75MHz	82pF	400 to 900MHz(@20dB)	100mA	25VDC	
KNA32100C65DA3TS	100MHz	65pF	450 to 950MHz(@20dB)	100mA	25VDC	
KNA32150C45DA3TS	150MHz	45pF	600 to 1100MHz(@20dB)	100mA	25VDC	
KNA32200C35DA3TS	200MHz	35pF	700 to 1200MHz(@20dB)	100mA	25VDC	

• Storage condition
 Temperature: -10 to +45°C
 Humidity: 45 to 75%RH

Dimensions

(Unit: mm)

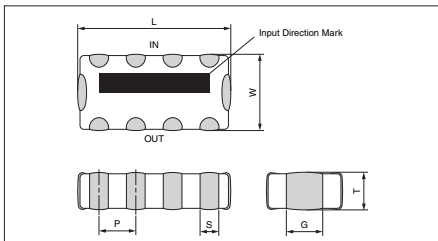

CODE	L	W	T
Dimensions	3.2±0.2	1.6±0.2	0.75±0.1
CODE	P	S	G
Dimensions	0.8	0.35±0.15	0.80±0.20

Attenuation Characteristics

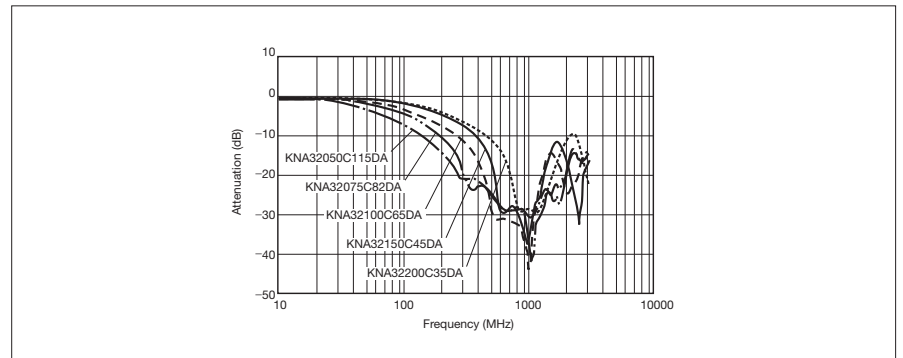

Recommended Land Pattern

(Unit: mm)

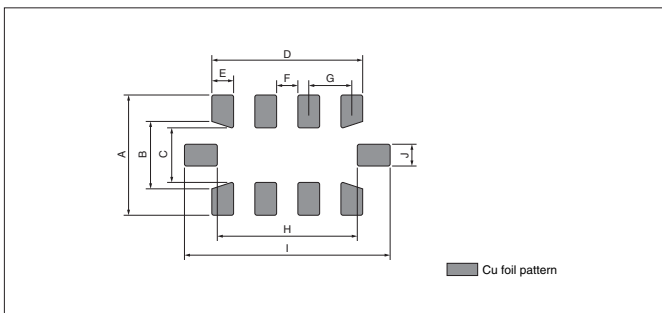

CODE	A	B	C	D	E	F	G	H	I	J
Dimensions	2.20	1.30	1.00	2.80	0.40	0.40	0.80	2.60	3.80	0.4

Packaging Specification

- Taping (3,000/ reel)

(Unit: mm)

