



Frontier Electronics Corp.

667 E. COCHRAN STREET, SIMI VALLEY, CA 93065

TEL: (805) 522-9998 FAX: (805) 522-9989

E-mail: frontiersales@frontierusa.com

Web: <http://www.frontierusa.com>

2A ULTRA FAST RECOVERY SURFACE MOUNT RECTIFIER

MURS205-LFR THRU MURS260-LFR

FEATURES

- LOW PROFILE PACKAGE
- PLASTIC PACKAGE HAS UNDERWRITERS LABORATORY 94V-0
- IDEAL FOR SURFACE MOUNTED APPLICATION
- GLASS PASSIVATED CHIP JUNCTION
- BUILT-IN STRAIN RELIEF DESIGN
- ULTRA FAST RECOVERY TIME FOR HIGH EFFICIENT
- HIGH TEMPERATURE SOLDERING : 250 °C/10 SECONDS AT TERMINALS
- ROHS

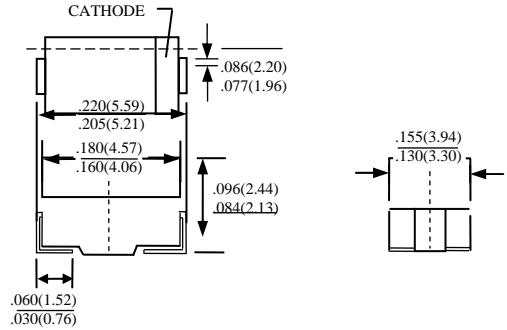

MECHANICAL DATA

- CASE: JEDEC DO-214AA MOLDED PLASTIC BODY, DO-214AA (SMB) DIMENSIONS IN INCHES AND (MILLIMETERS)
- TERMINAL: SOLDER PLATED, SOLDERABLE PER MIL-STD-750 METHOD 2026
- POLARITY: COLOR BAND DENOTES CATHODE
- WEIGHT: 0.093 GRAMS

MAXIMUM RATINGS AND ELECTRICAL CHARACTERISTICS RATINGS AT 25°C AMBIENT TEMPERATURE UNLESS OTHERWISE SPECIFIED SINGLE PHASE, HALF WAVE, 60 HZ, RESISTIVE OR INDUCTIVE LOAD. FOR CAPACITIVE LOAD, DERATE CURRENT BY 20%

RATINGS	SYMBOL	MURS 205-LFR	MURS 210-LFR	MURS 215-LFR	MURS 220-LFR	MURS 240-LFR	MURS 260-LFR	UNITS
MAXIMUM RECURRENT PEAK REVERSE VOLTAGE	V_{RRM}	50	100	150	200	400	600	V
MAXIMUM RMS VOLTAGE	V_{RMS}	35	70	105	140	280	420	V
MAXIMUM DC BLOCKING VOLTAGE	V_{DC}	50	100	150	200	400	600	V
MAXIMUM AVERAGE FORWARD RECTIFIED CURRENT AT $T_J=75^\circ\text{C}$	I_O	2.0						A
PEAK FORWARD SURGE CURRENT, 8.3ms SINGLE HALF SINE-WAVE SUPERIMPOSED ON RATED LOAD	I_{FSM}	40				35		A
TYPICAL JUNCTION CAPACITANCE (NOTE 1)	C_J	50						PF
TYPICAL THERMAL RESISTANCE (NOTE 2)	$R_{\theta JL}$	15						°C/W
STORAGE TEMPERATURE RANGE	T_{STG}	-55 TO + 150						°C
OPERATING TEMPERATURE RANGE	T_{OP}	-55 TO + 150						°C

ELECTRICAL CHARACTERISTICS ($A_T, T_A = 25^\circ\text{C}$ UNLESS OTHERWISE NOTED)

CHARACTERISTICS	SYMBOL	MURS 205-LFR	MURS 210-LFR	MURS 215-LFR	MURS 220-LFR	MURS 240-LFR	MURS 260-LFR	UNITS
MAXIMUM FORWARD VOLTAGE AT I_O DC	V_F	0.94				1.45		V
MAXIMUM DC REVERSE CURRENT AT $T_A=25^\circ\text{C}$	I_R	2				5		μA
MAXIMUM DC REVERSE CURRENT AT $T_A=125^\circ\text{C}$	I_R	250						μA
MAXIMUM REVERSE RECOVERY TIME (NOTE 3)	T_{RR}	20				50		nS
MARKING		U2A	U2B	U2C	U2D	U2G	U2J	

NOTES : 1. MEASURED AT 1 MHZ AND APPLIED REVERSE VOLTAGE OF 4.0 VOLTS

2. THERMAL RESISTANCE FROM JUNCTION TO AMBIENT AND JUNCTION TO LEAD P.C.B. MOUNTED ON 0.3x0.3" (8.0x8.0 mm) COPPER PAD AREAS

3. REVERSE RECOVERY TEST CONDITIONS: $I_F=0.5\text{A}$, $I_R=1.0\text{A}$, $I_{RR}=0.25\text{A}$

RATINGS AND CHARACTERISTIC CURVE MURS305-LFR THRU MURS360-LFR

FIG. 1-TEST CIRCUIT DIAGRAM AND REVERSE RECOVERY TIME CHARACTERISTIC

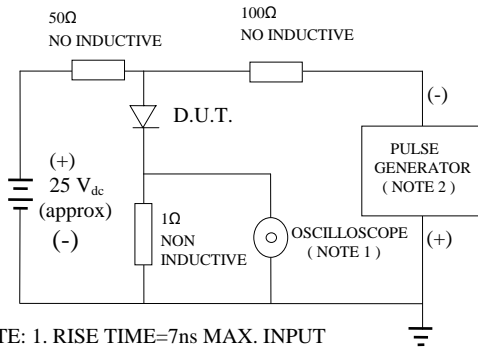

NOTE: 1. RISE TIME=7ns MAX. INPUT IMPEDANCE=1 MOhms 22PF
 2. RISE TIME =10ns MAX. SOURCE IMPEDANCE=50 OHMS

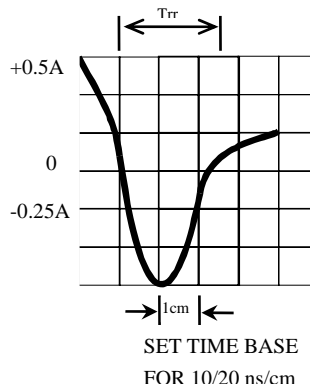

FIG. 2-TYPICAL FORWARD CURRENT DERATING CURVE

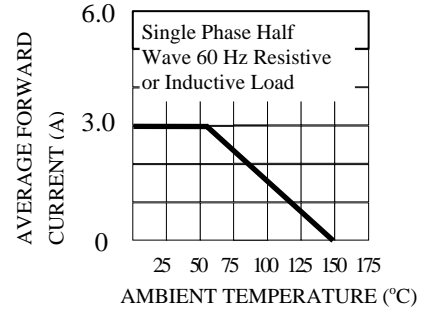

FIG. 3-TYPICAL REVERSE CHARACTERISTICS

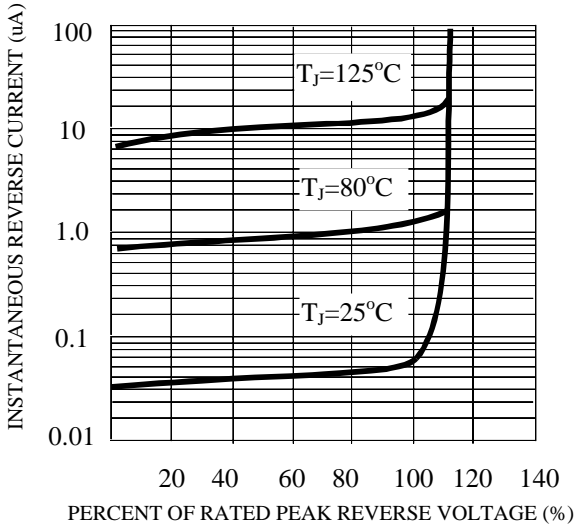

FIG. 4-TYPICAL INSTANTANEOUS FORWARD CHARACTERISTICS

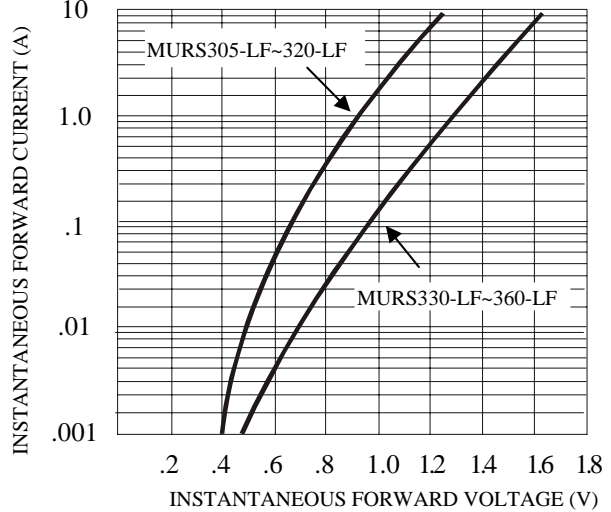

FIG. 5-MAXIMUM NON-REPETITIVE FORWARD SURGE CURRENT

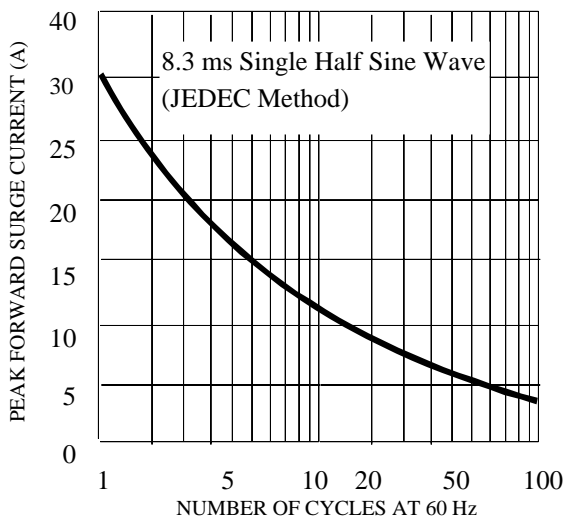

FIG. 6-TYPICAL JUNCTION CAPACITANCE

