



# UTD36N03

Power MOSFET

## N-CHANNEL ENHANCEMENT MODE

### ■ FEATURES

- \*  $R_{DS(ON)} = 17m\Omega @ V_{GS} = 10 V$
- \* Low capacitance
- \* Optimized gate charge
- \* Fast switching capability
- \* Avalanche energy specified

### ■ SYMBOL

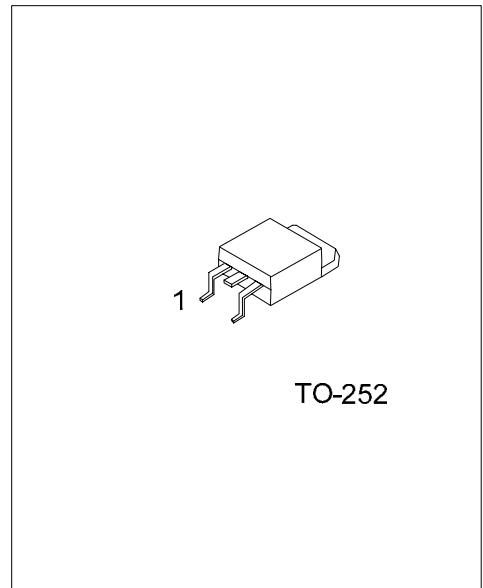
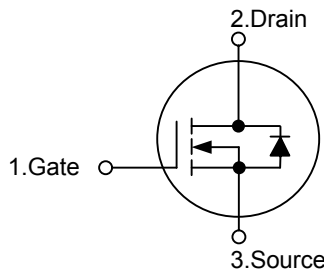

\*Pb-free plating product number: UTD36N03L

### ■ ORDERING INFORMATION

Ordering Number		Package	Pin Assignment			Packing
Normal	Lead Free Plating		1	2	3	
UTD36N03-TN3-R	UTD36N03L-TN3-R	TO-252	G	D	S	Tape Reel
UTD36N03-TN3-T	UTD36N03L-TN3-T	TO-252	G	D	S	Tube

<p>UTD36N03L-TN3-R</p> <p>(1)Packing Type</p> <p>(2)Package Type</p> <p>(3)Lead Plating</p>	<p>(1) R: Tape Reel, T: Tube</p> <p>(2) TN3: TO-252</p> <p>(3) L: Lead Free Plating, Blank: Pb/Sn</p>
---	---

■ ABSOLUTE MAXIMUM RATINGS ( $T_J=25^{\circ}\text{C}$ , unless otherwise specified)

PARAMETER	SYMBOL	RATINGS	UNIT
Drain-Source Voltage	$V_{DSS}$	30	V
Gate-Source Voltage	$V_{GSS}$	$\pm 20$	V
Continuous Drain Current	$I_D$	43.4	A
Pulsed Drain Current (Note 1)	$I_{DM}$	173.6	A
Power Dissipation	$P_D$	57.6	W
Junction Temperature	$T_J$	+175	
Storage Temperature	$T_{STG}$	-55 ~ +175	

Note: Absolute maximum ratings are those values beyond which the device could be permanently damaged.

Absolute maximum ratings are stress ratings only and functional device operation is not implied.

■ THERMAL DATA

PARAMETER	SYMBOL	MIN	TYP	MAX	UNIT
Junction-to-Ambient	$\theta_{JA}$			75	/W

■ ELECTRICAL CHARACTERISTICS ( $T_J=25^{\circ}\text{C}$ , unless otherwise specified)

PARAMETER	SYMBOL	TEST CONDITIONS	MIN	TYP	MAX	UNIT
<b>OFF CHARACTERISTICS</b>						
Drain-Source Breakdown Voltage	$BV_{DSS}$	$V_{GS}=0V, I_D=250\ \mu A$	30			V
Drain-Source Leakage Current	$I_{DSS}$	$V_{DS}=24V, V_{GS}=0V$		0.05	1	$\mu A$
Gate-Source Leakage Current	$I_{GSS}$	$V_{GS}=\pm 20V, V_{DS}=0V$		10	100	nA
<b>ON CHARACTERISTICS</b>						
Gate-Threshold Voltage	$V_{GS(TH)}$	$V_{DS}=V_{GS}, I_D=250\ \mu A$	1	1.5	2	V
Drain-Source On-State Resistance	$R_{DS(ON)}$	$V_{GS}=4.5V, I_D=12A$		18	22	m $\Omega$
		$V_{GS}=10V, I_D=25A$		14	17	
<b>DYNAMIC CHARACTERISTICS</b>						
Input Capacitance	$C_{ISS}$	$V_{DS}=25V, V_{GS}=0V, f=1.0MHz$		690		pF
Output Capacitance	$C_{OSS}$			160		
Reverse Transfer Capacitance	$C_{RSS}$			110		
<b>SWITCHING PARAMETERS</b>						
Turn-ON Delay Time	$t_{D(ON)}$	$V_{DS}=15V, V_{GS}=10V, R_G=10\Omega, R_L=0.6\Omega$		6		ns
Turn-ON Rise Time	$t_R$			10		
Turn-OFF Delay Time	$t_{D(OFF)}$			33		
Turn-OFF Fall-Time	$t_F$			19		
Total Gate Charge	$Q_G$	$V_{DS}=15V, V_{GS}=10V, I_D=36A$		18.5		nC
Gate-Source Charge	$Q_{GS}$			4.2		
Gate-Drain Charge	$Q_{GD}$			2.9		
<b>SOURCE- DRAIN DIODE RATINGS AND CHARACTERISTICS</b>						
Drain-Source Diode Forward Voltage	$V_{SD}$	$I_S=25A, V_{GS}=0V$		0.97	1.2	V
Maximum Continuous Drain-Source Diode Forward Current	$I_S$				43.4	A
Maximum Pulsed Drain-Source Diode Forward Current	$I_{SM}$				173.6	
Reverse Recovery Time	$t_{RR}$	$V_R=15V, I_F=I_S, dI_F/dt=100A/\mu s$		15	18	ns
Reverse Recovery Charge	$Q_{RR}$			2	3	nC

Notes: 1. Pulse width limited by  $T_{J(MAX)}$

2. Pulse width  $\leq 300\mu s$ , duty cycle  $\leq 2\%$ .

## TYPICAL CHARACTERISTICS

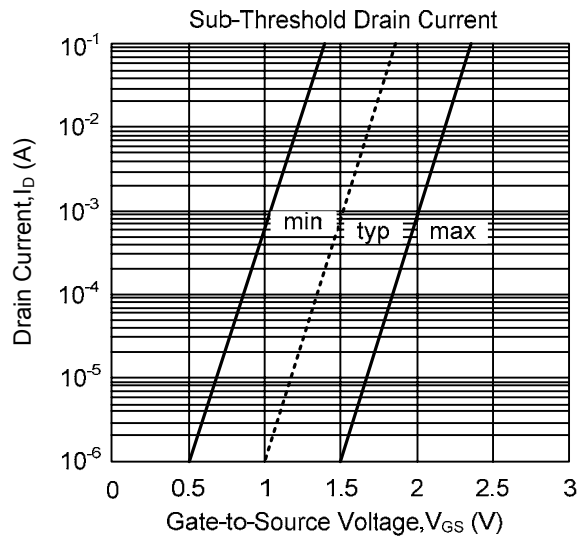
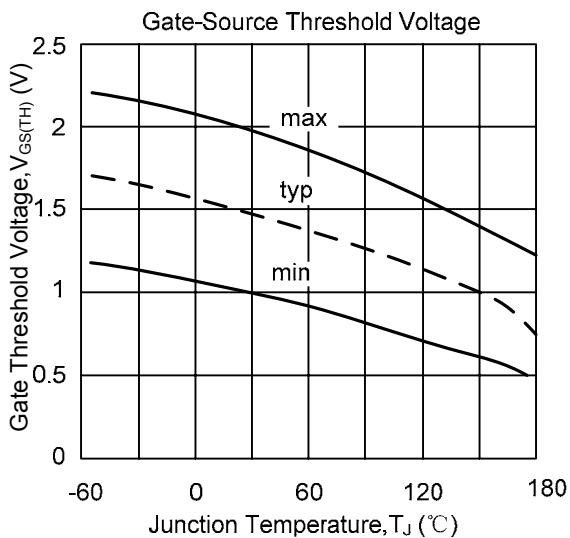
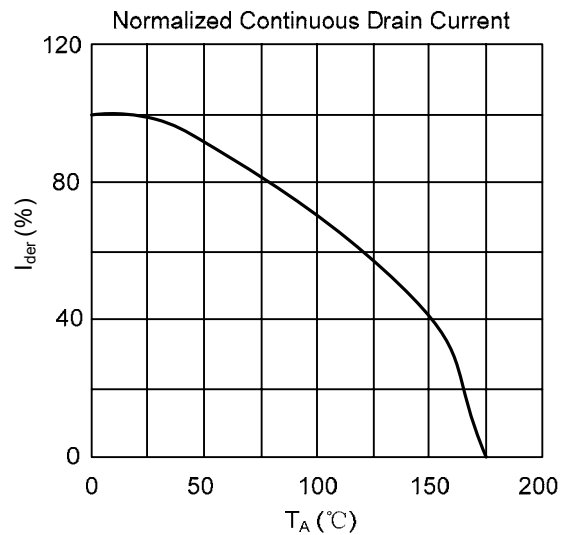
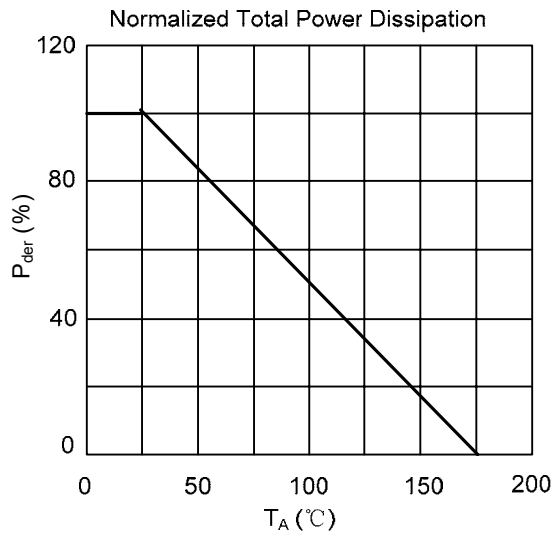
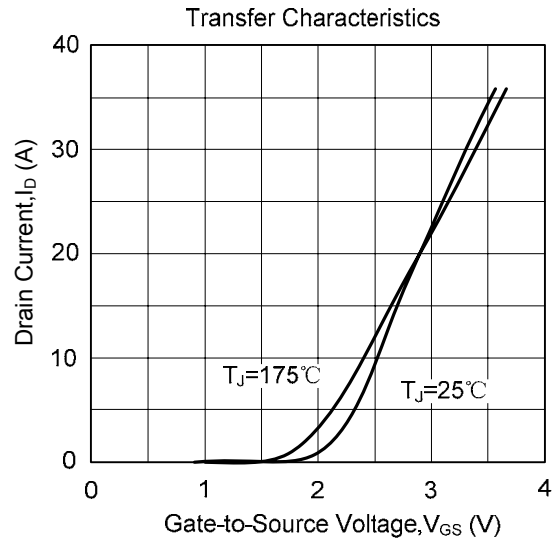
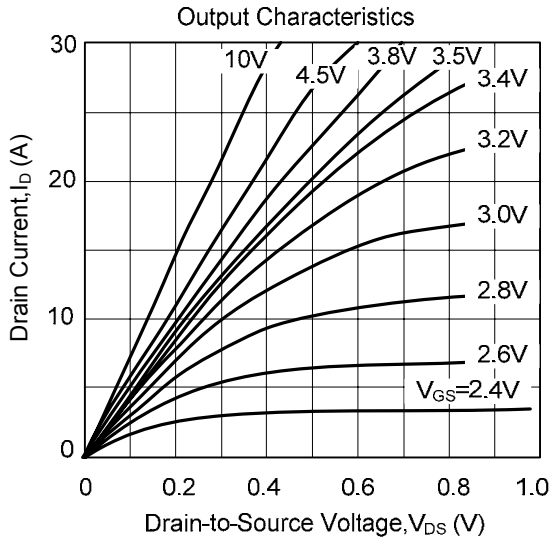

## ■ TYPICAL CHARACTERISTICS(Cont.)

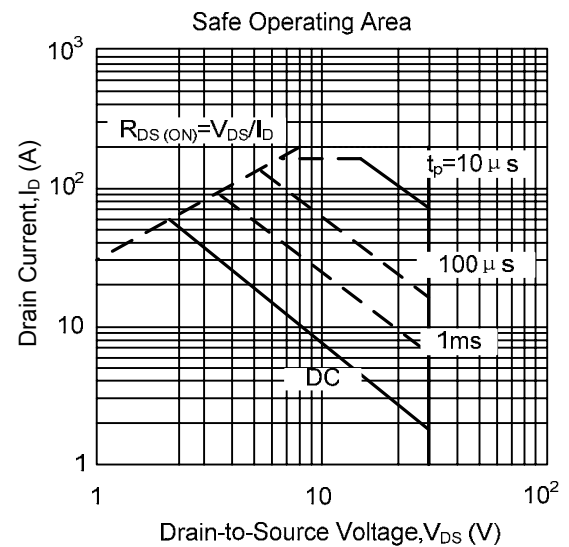
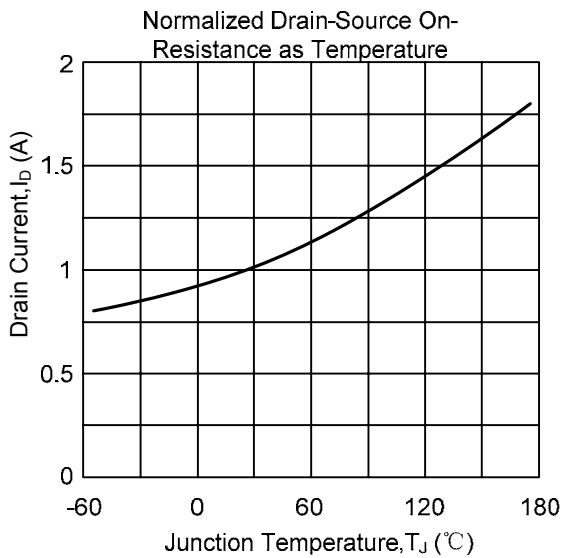
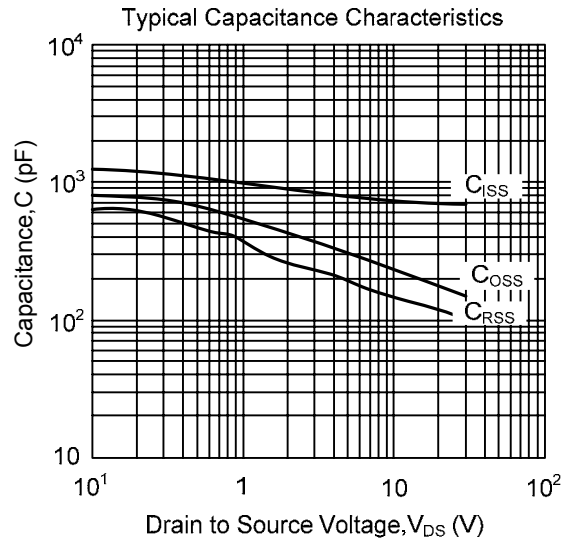
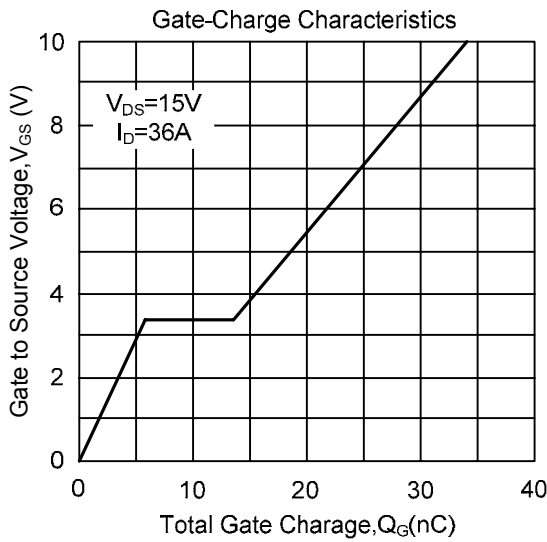
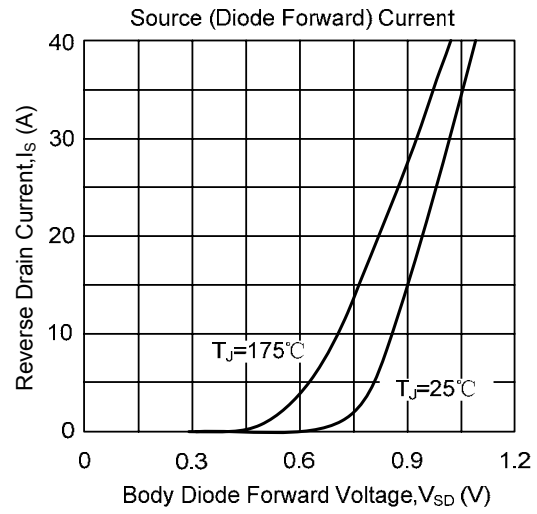
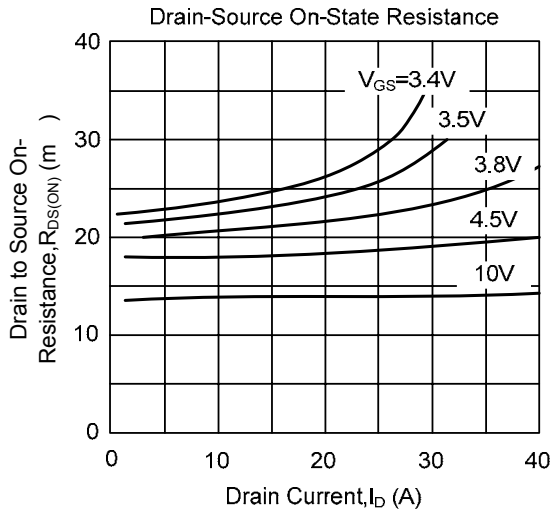

■ TYPICAL CHARACTERISTICS(Cont.)

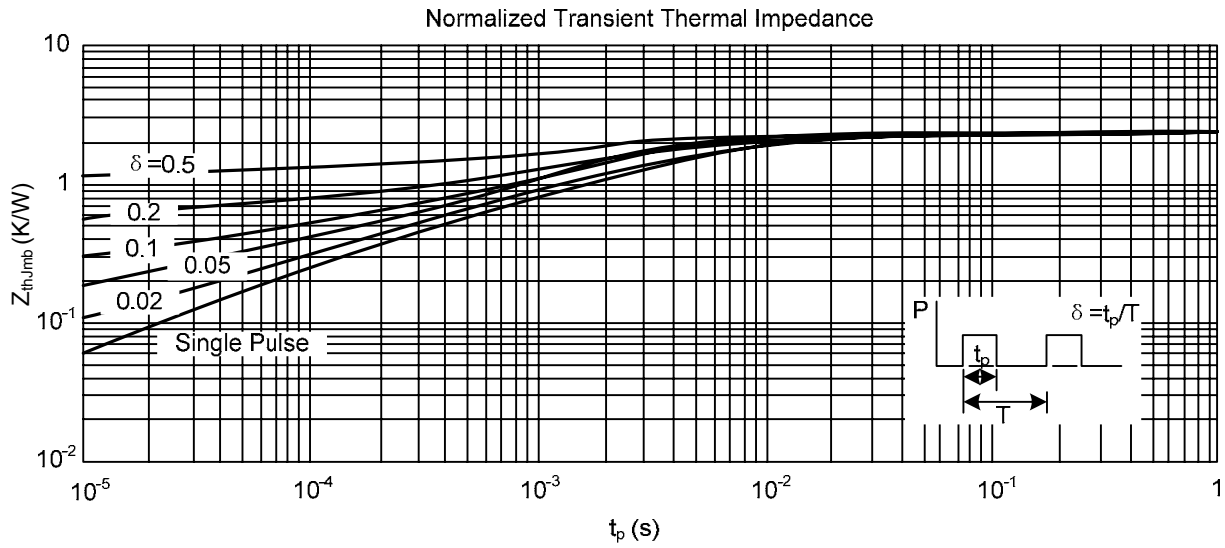

UTC assumes no responsibility for equipment failures that result from using products at values that exceed, even momentarily, rated values (such as maximum ratings, operating condition ranges, or other parameters) listed in products specifications of any and all UTC products described or contained herein. UTC products are not designed for use in life support appliances, devices or systems where malfunction of these products can be reasonably expected to result in personal injury. Reproduction in whole or in part is prohibited without the prior written consent of the copyright owner. The information presented in this document does not form part of any quotation or contract, is believed to be accurate and reliable and may be changed without notice.