



SOT-25



Pin Definition:

1. EN
2. Ground
3. Switching Output
4. Input
5. Feedback

General Description

TS3410 is a high efficiency monolithic synchronous buck regulator using a constant frequency, current mode architecture. The device is available in an adjustable version. Supply current with no load is 250uA and drops to <1uA in shutdown. The 2.5V to 6V input voltage range makes TS3410 ideally suited for single Li-Ion, two to four AA battery-powered applications. 100% duty cycle provides low dropout operation, extending battery life in portable systems. PWM pulse skipping mode operation provides very low output ripple voltage for noise sensitive applications. Switching frequency is internally set at 1.4MHz, allowing the use of small surface mount inductors and capacitors. The internal synchronous switch increases efficiency and decreases need of an external Schottky diode. Low output voltages are easily supported with the 0.6V feedback reference voltage.

Features

- High Efficiency: Up to 96%
- 2.5V to 6V Input Voltage Range
- Output Voltage from 0.6V to VIN
- Short Circuit Protection (SCP)
- Build in Soft-Start Function
- 1.4MHz Constant Frequency Operation
- Up to 1A Output Current
- Low Quiescent Current: 250uA (Typ.)
- No Schottky Diode Required in Application
- ≤1uA Shutdown Current
- Current Mode Operation for Excellent Line and Load Transient Response

Application

- Cellular Phones
- Digital Still Cameras
- Portable Electronics
- USB Devices

Pin Description

Name	Description
EN	Power-off pin H : normal operation L : Step-down operation stopped (All circuits deactivated)
GND	Ground pin
SW	Switch output pin. Connect external inductor here. Minimize trace area at this pin to reduce EMI.
VCC	IC power supply pin
FB	Output Feedback pin

Ordering Information

Part No.	Package	Packing
TS3410CX5 RF	SOT-25	3Kpcs/ 7" Reel

Application Circuit

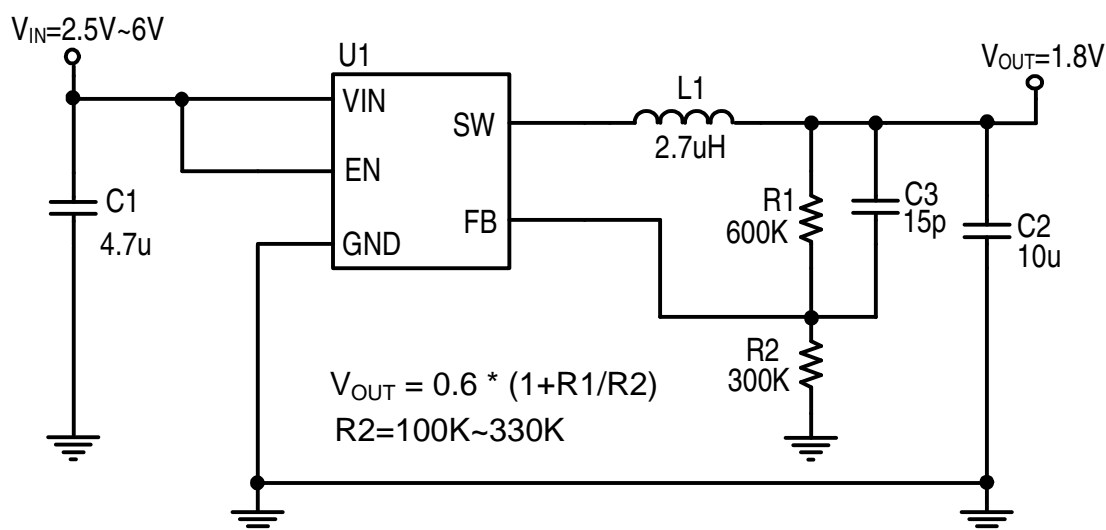

Absolute Maximum Rating

Characteristics	Symbol	Rating	Unit
V _{IN} Pin Voltage	V _{IN}	Gnd - 0.3 to Gnd + 6.5	V
Feedback Pin Voltage	V _{FB}	Gnd - 0.3 to V _{IN} + 0.3	V
RUN Pin Voltage	V _{RUN}	Gnd - 0.3 to V _{IN} + 0.3	V
Switch Pin Voltage	V _{SW}	Gnd - 0.3 to V _{IN} + 0.3	V
Peak SW Sink & Source Current	I _{PSW}	1.4	A
Power Dissipation	P _D	(T _J -T _A) / θ _{JA}	mW
Storage Temperature Range	T _{ST}	-40 to +150	°C
Operating Temperature Range	T _{OP}	-40 to +85	°C
Junction Temperature	T _J	+125	°C
Thermal Resistance from Junction to case	θ _{JC}	110	°C/W
Thermal Resistance from Junction to ambient	θ _{JA}	250	°C/W

Note1: θ_{JA} is measured with the PCB copper area of approximately 1 in² (Multi-layer). that need connect to Gnd pin of the TS3410.

Electrical Specifications (T_A = 25°C, V_{IN}=V_{RUN}=3.6V unless otherwise noted)

Characteristics	Symbol	Conditions	Min	Typ	Max	Units
Feedback Voltage	V _{FB}	T _A = 25°C, I _{OUT} = 50mA	0.588	0.6	0.612	V
		-40°C ≤ T _A ≤ 85°C	0.582	0.6	0.618	
Quiescent Current	I _{CCQ}	V _{FB} = 0.5V	--	250	350	uA
Feedback Bias Current	I _{FB}	V _{FB} = 0.65V	--	--	±30	nA
Shutdown Supply Current	I _{SD}	V _{RUN} = 0V	--	0.1	1	uA
Maximum Output Current	I _{OUT(MAX)}	V _{CC} = 3V, V _{OUT} = 1.8V	1	--	--	A
Current Limit	I _{LIMIT}	V _{CC} = 3V	1.2	1.4	--	A
Line Regulation	ΔV _{OUT} /V _{OUT}	V _{CC} = 2.5V~5.5V	--	0.04	0.4	%
Load Regulation	ΔV _{OUT} /V _{OUT}	I _{OUT} = 0.01 to 0.6A	--	0.5	--	%
Oscillation Frequency	F _{OSC}	SW pin	1.1	1.4	1.7	MHz
R _{DS(ON)} of P-CH MOSFET	R _{DSON}	I _{SW} = 500mA	--	0.3	0.4	Ω
R _{DS(ON)} of N-CH MOSFET	R _{DSON}	Note 1	--	0.25	0.35	Ω
Efficiency	E _{FFI}	V _{OUT} = 3.3V, I _{OUT} = 0.5A	--	94	--	%
EN pin logic Input Threshold Voltage	V _{ENL}		--	--	0.4	V
	V _{ENH}		1.5	--	--	
EN Pin Input Current	I _{EN}		--	±0.1	±1	uA
Thermal shutdown	T _{DS}		--	140	--	°C
Thermal shutdown Hysteresis	T _{SH}		--	30	--	°C

Note 1: Guaranteed by Design

Note 2: 100% production test at +25°C. Specifications over the temperature range are guaranteed by design and characterization.

Block Diagram

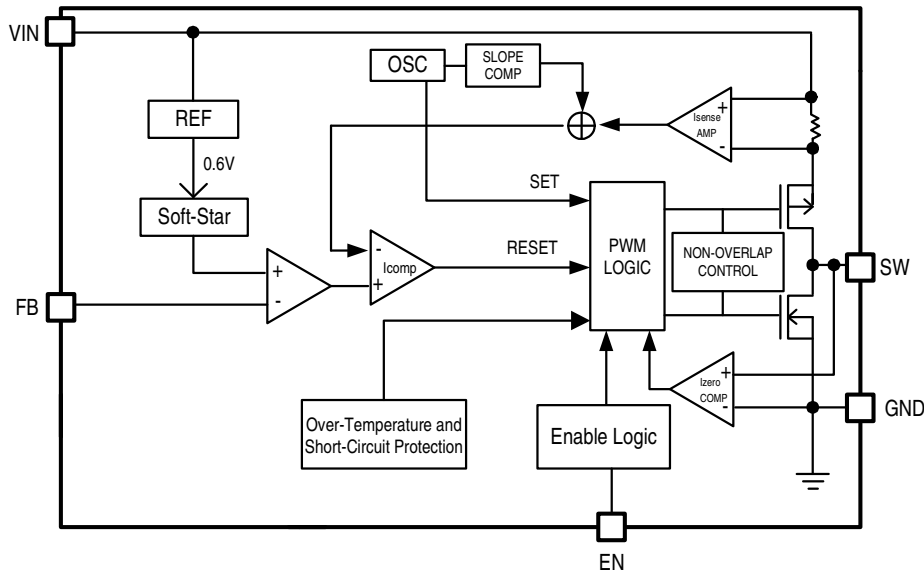

Function Description

Operation

TS3410 is a monolithic switching mode step-down DC-DC converter. It utilizes internal MOSFETs to achieve high efficiency and can generate very low output voltage by using internal reference at 0.6V. It operates at a fixed switching frequency, and uses the slope compensated current mode architecture. This step-down DC-DC Converter supplies minimum 1000mA output current at input voltage range from 2.5V to 5.5V.

Current Mode PWM Control

Slope compensated current mode PWM control provides stable switching and cycle-by-cycle current limit for excellent load and line transient responses and protection of the internal main switch (P-Ch MOSFET) and synchronous rectifier (N-CH MOSFET). During normal operation, the internal P-Ch MOSFET is turned on for a certain time to ramp the inductor current at each rising edge of the internal oscillator, and switched off when the peak inductor current is above the error voltage. The current comparator, ICOMP, limits the peak inductor current. When the main switch is off, the synchronous rectifier will be turned on immediately and stay on until either the inductor current starts to reverse, as indicated by the current reversal comparator, IZERO, or the beginning of the next clock cycle..

Application Information

Setting the Output Voltage

Application circuit item shows the basic application circuit with TS3410 adjustable output version. The external resistor sets the output voltage according to the following formula:

$$V_{out} = 0.6V \times \left(1 + \frac{R1}{R2}\right)$$

Table 1: Resistor Select for Output Voltage Setting

VOUT	R2	R1
1.2V	300K	300K
1.5V	300K	450K
1.8V	300K	600K
2.5V	150K	470K
3.3V	120K	540K
5V	124K	910K

Inductor Selection

For most designs, the TS3410 operates with inductors of 2.2μH to 3.3μH. Low inductance values are physically smaller but require faster switching, which results in some efficiency loss. The inductor value can be derived from the following formula:

$$L = \frac{V_{out} \times (V_{in} - V_{out})}{V_{in} \times \Delta I_L \times F_{osc}}$$

Table 2: Inductor Select for Output Voltage Setting (V_{IN}=3.6V)

VOUT	1.2V	1.5V	1.8V	2.5V
Inductor	2.7uH	2.7uH	2.7uH	2.2uH
Part Number WE-TPC	7440430027	7440430027	7440430027	7440430022

Note: Part Type MH or M (www.we-online.com)

Where is inductor Ripple Current. Large value inductors lower ripple current and small value inductors result in high ripple currents. Choose inductor ripple current approximately 20% of the maximum load current 1A, ΔIL=200mA.

For output voltages above 2.0V, when light-load efficiency is important, the minimum recommended inductor is 2.7μH. For optimum voltage-positioning load transients, choose an inductor with DC series resistance in the 50mΩ to 150mΩ range. For higher efficiency at heavy loads (above 200mA), or minimal load regulation (but some transient overshoot), the resistance should be kept below 100mΩ. The DC current rating of the inductor should be at least equal to the maximum load current plus half the ripple current to prevent core saturation (1000mA+100mA)

Input Capacitor Selection

The input capacitor reduces the surge current drawn from the input and switching noise from the device. The input capacitor impedance at the switching frequency shall be less than input source impedance to prevent high frequency switching current passing to the input. A low ESR input capacitor sized for maximum RMS current must be used. Ceramic capacitors with X5R or X7R dielectrics are highly recommended because of their low ESR and small temperature coefficients. A 4.7μF ceramic capacitor for most applications is sufficient.

Output Capacitor Selection

The output capacitor is required to keep the output voltage ripple small and to ensure regulation loop stability. The output capacitor must have low impedance at the switching frequency. Ceramic capacitors with X5R or X7R dielectrics are recommended due to their low ESR and high ripple current.

Compensation Capacitor Selection

The compensation capacitors for increasing phase margin provide additional stability. It is required and more than 15pF. Please refer to demo board schematic for design.

Electrical Characteristics Curve

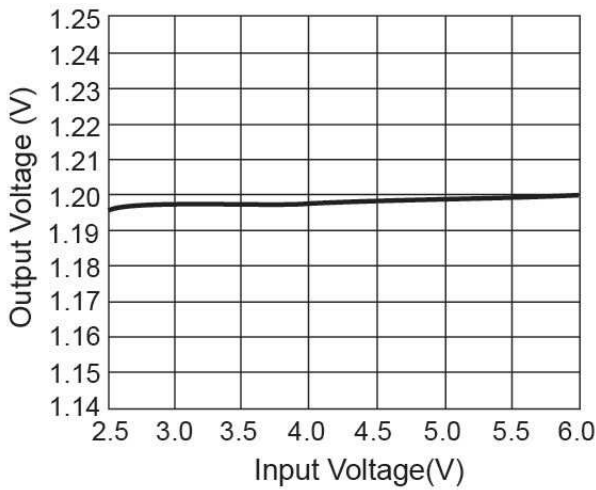

Figure 1. Output Voltage vs. Input Voltage

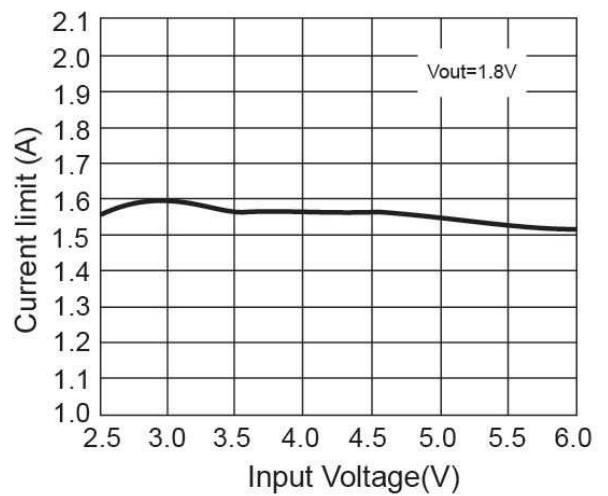

Figure 2. Current Limit vs. Input Voltage

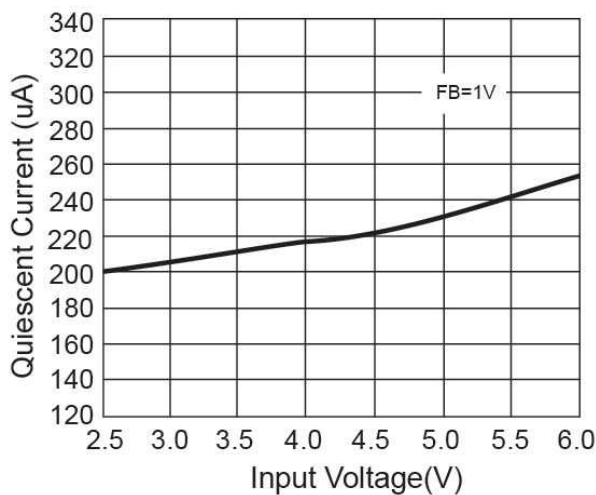

Figure 3. Quiescent Current vs. Input Voltage

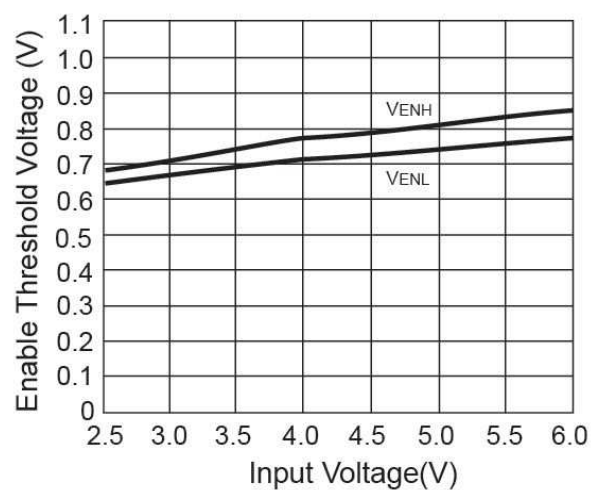

Figure 4. Threshold Voltage vs. Input Voltage

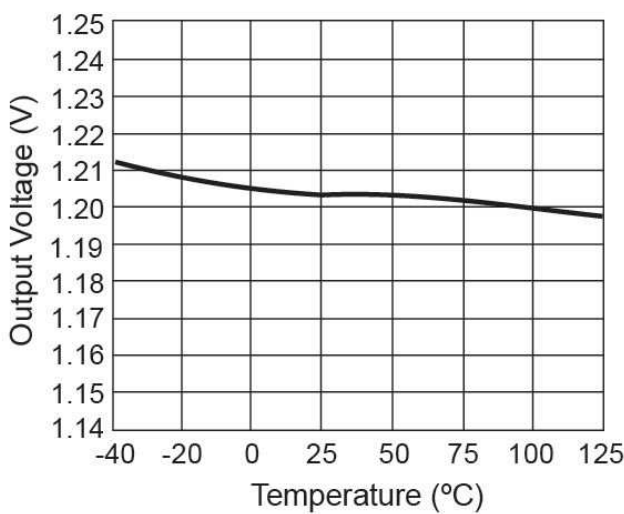

Figure 5. Output Voltage vs. Temperature

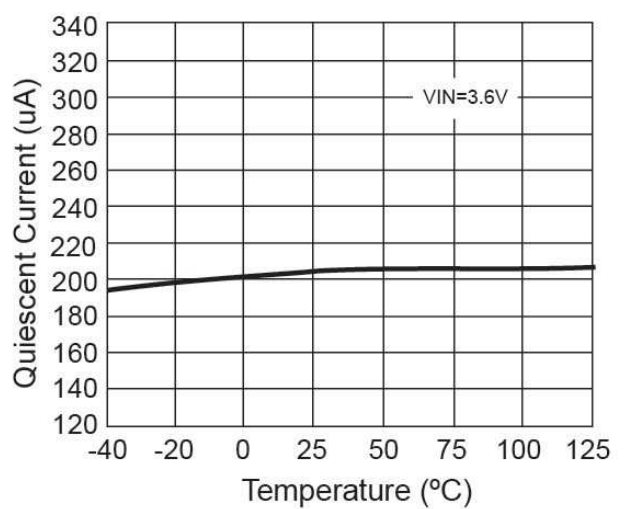

Figure 6. Quiescent Current vs. Temperature

Electrical Characteristics Curve

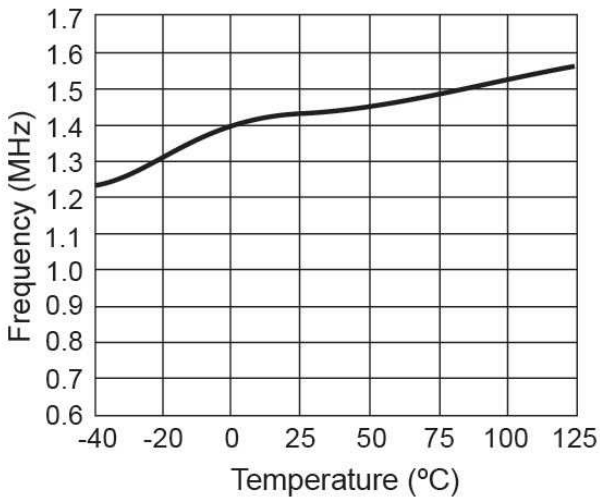

Figure 7. Frequency vs. Temperature

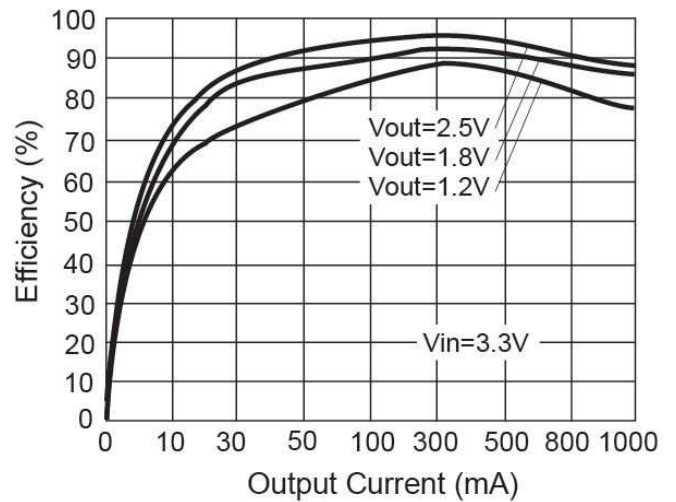

Figure 8. Efficiency vs. Output Current

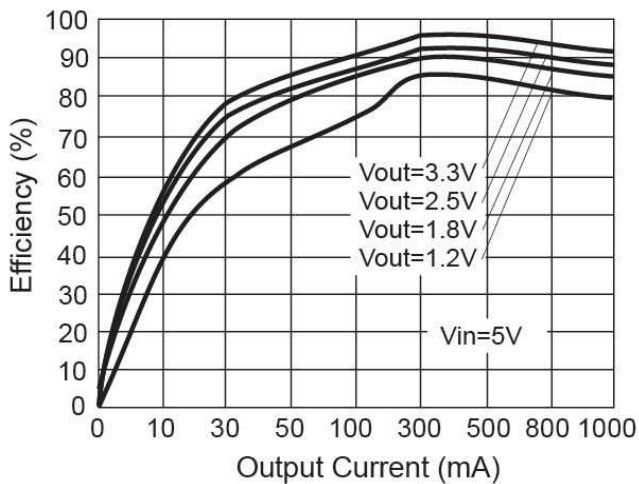

Figure 9. Efficiency vs. Output Current

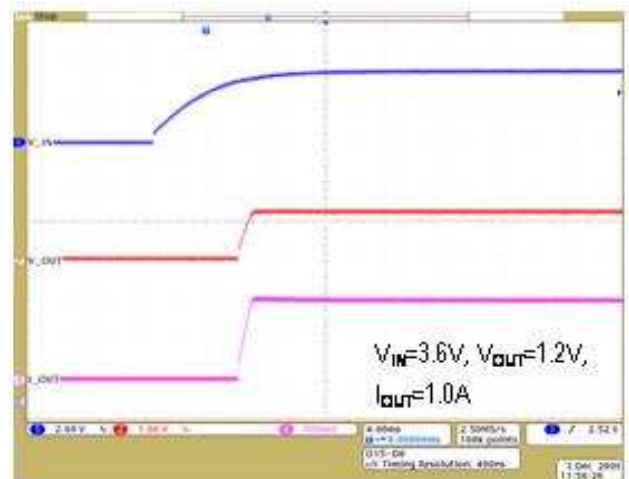

Figure 10. Power-On Waveform

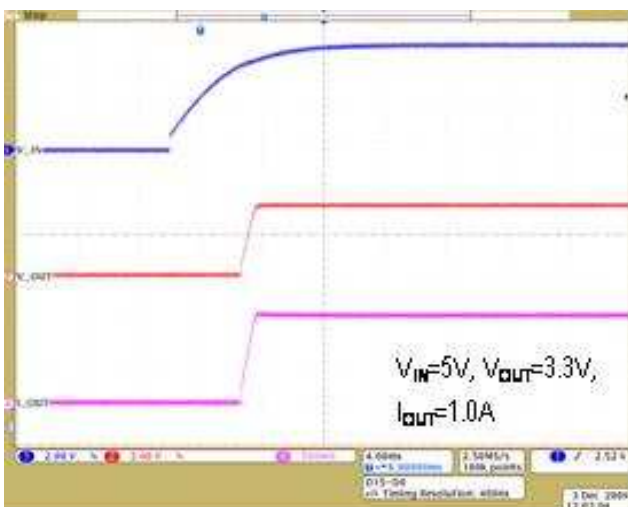

Figure 11. Power-On Waveform

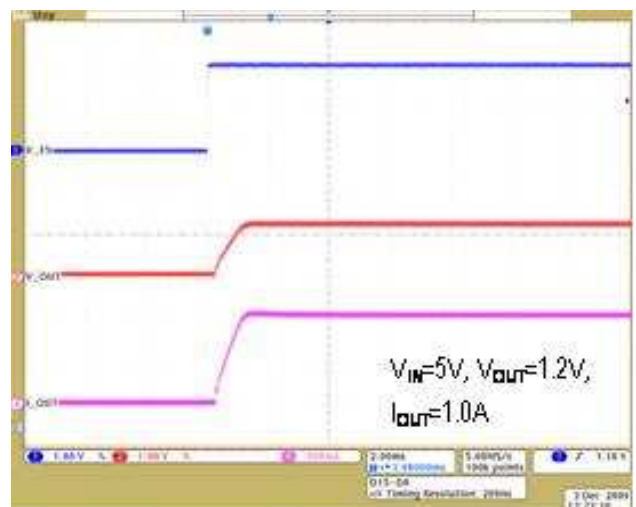

Figure 12. Enable-ON Waveform

Electrical Characteristics Curve

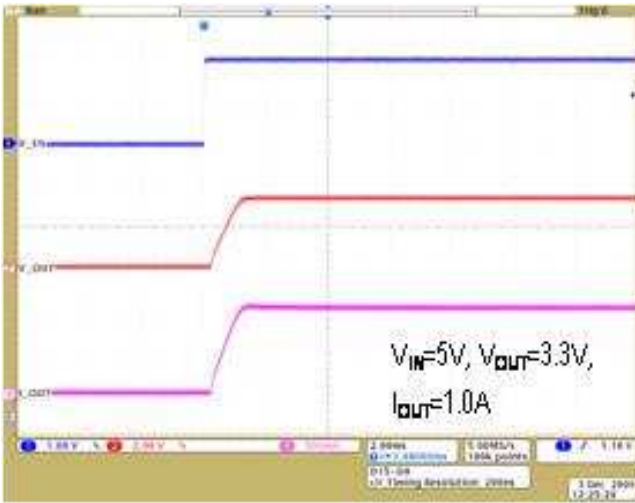

Figure 13. Enable-ON Waveform

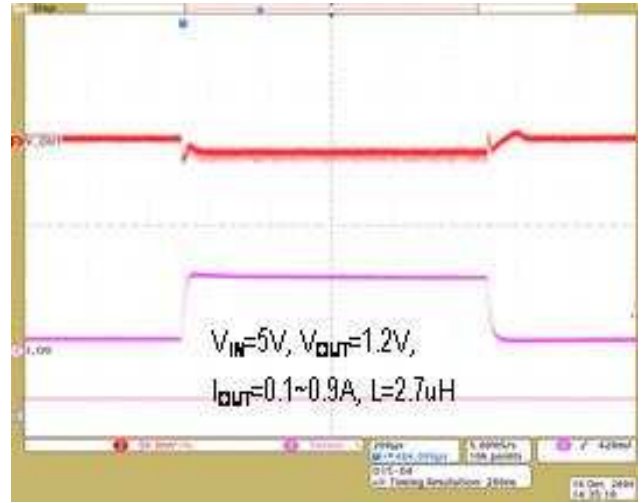

Figure 14. Load Transient

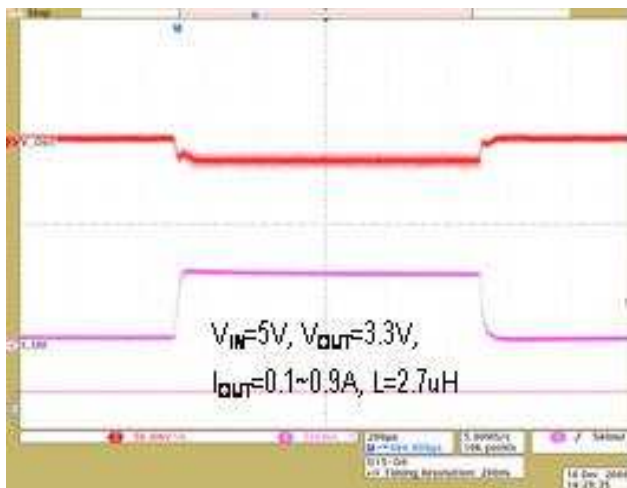

Figure 15. Load Transient

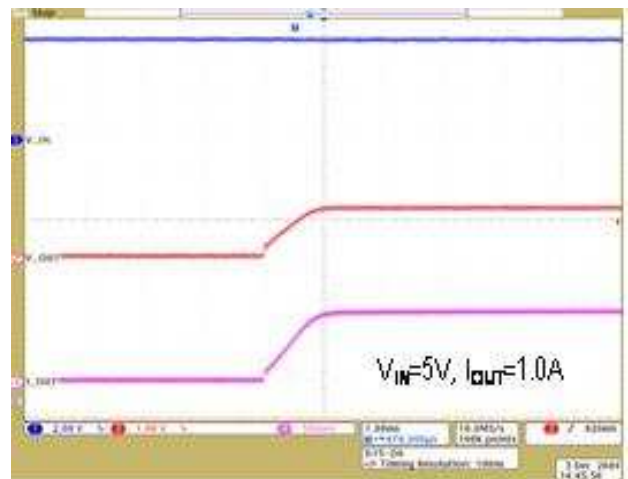

Figure 16. TSD to Release

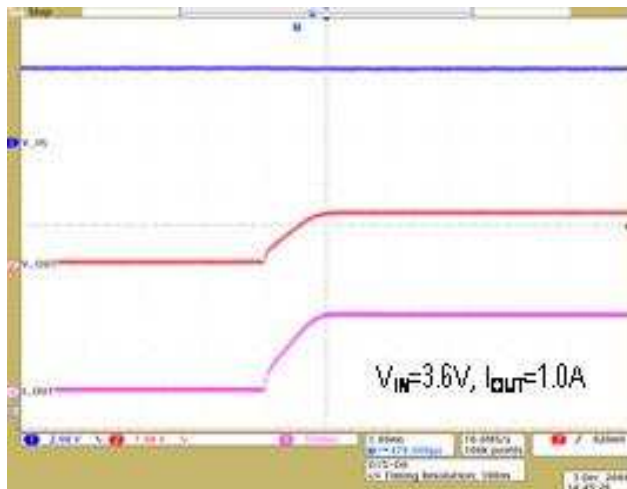
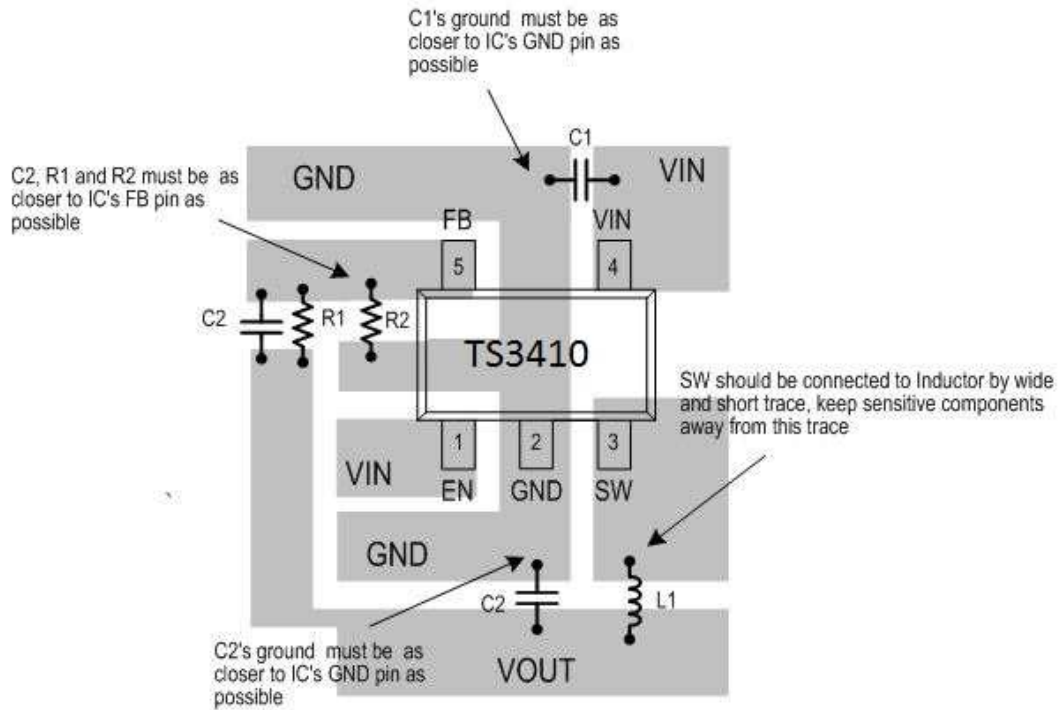

Figure 17. TSD to Release

Application Information (Continue)

Layout Guide



SOT-25 Mechanical Drawing

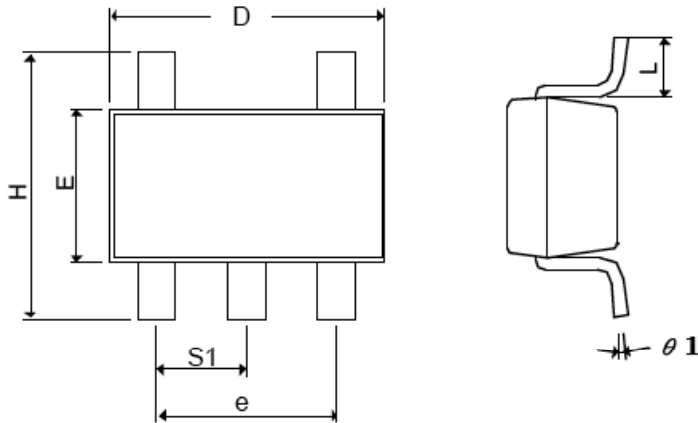

DIM	MILLIMETERS		INCHES	
	MIN	MAX	MIN	MAX.
A+A1	0.09	1.25	0.0354	0.0492
B	0.30	0.50	0.0118	0.0197
C	0.09	0.25	0.0035	0.0098
D	2.70	3.10	0.1063	0.1220
E	1.40	1.80	0.0551	0.0709
E	1.90 BSC		0.0748 BSC	
H	2.40	3.00	0.09449	0.1181
L	0.35 BSC		0.0138 BSC	
θ1	0°	10°	0°	10°
S1	0.95 BSC		0.0374 BSC	

Front View

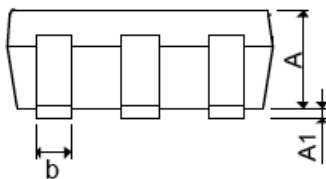

Marking Diagram

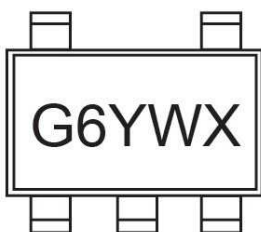

- G6** = Device Code
- Y** = Year Code
 - A = 2010
 - 1 = 2011
- W** = Week Code
 - 01 ~ 26 (A~Z)
 - 27 ~ 52 (a~z)
- X** = Internal ID Code

Notice

Specifications of the products displayed herein are subject to change without notice. TSC or anyone on its behalf, assumes no responsibility or liability for any errors or inaccuracies.

Information contained herein is intended to provide a product description only. No license, express or implied, to any intellectual property rights is granted by this document. Except as provided in TSC's terms and conditions of sale for such products, TSC assumes no liability whatsoever, and disclaims any express or implied warranty, relating to sale and/or use of TSC products including liability or warranties relating to fitness for a particular purpose, merchantability, or infringement of any patent, copyright, or other intellectual property right.

The products shown herein are not designed for use in medical, life-saving, or life-sustaining applications. Customers using or selling these products for use in such applications do so at their own risk and agree to fully indemnify TSC for any damages resulting from such improper use or sale.