



AKD4430-SA

AK4430 Evaluation Board Rev.1

General Description

AKD4430-SA is an evaluation board for AK4430 (192kHz sampling 24Bit Stereo $\Delta \Sigma$ DAC with 2Vrms Output). AKD4430-SA has a digital audio interface (AK4115) of Optical input and can easily achieve the interface with digital audio system. Therefore, it is easy to evaluate the sound quality of AK4430.

■ **Ordering Guide**

AKD4430-SA ---- AK4430 Evaluation Board

Function

- On-board digital audio interface. (AK4115)

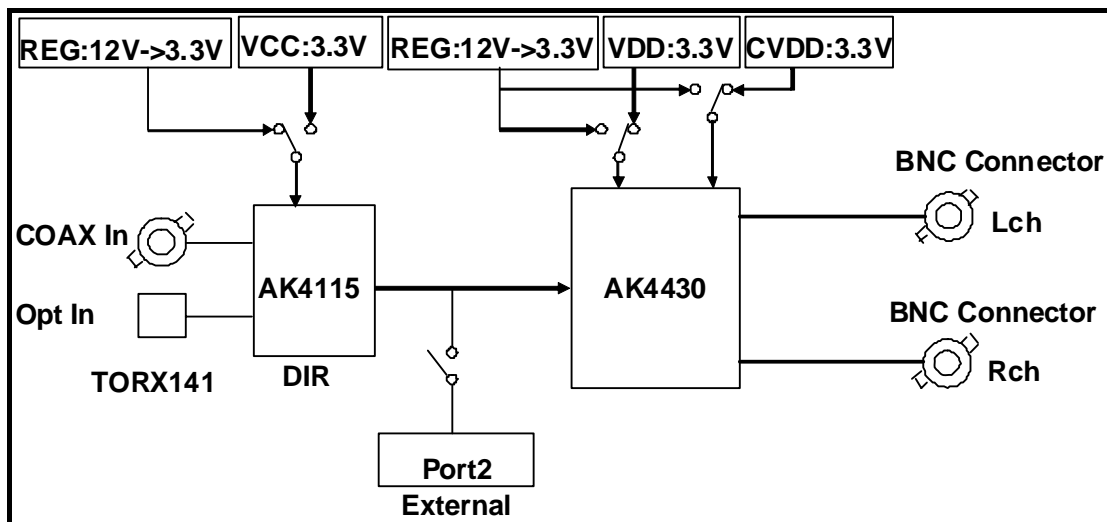

Figure 1. AKD4430-SA Block diagram
 (* Circuit diagram are attached at the end of this manual.)

Board Outline Chart

■ Outline Chart

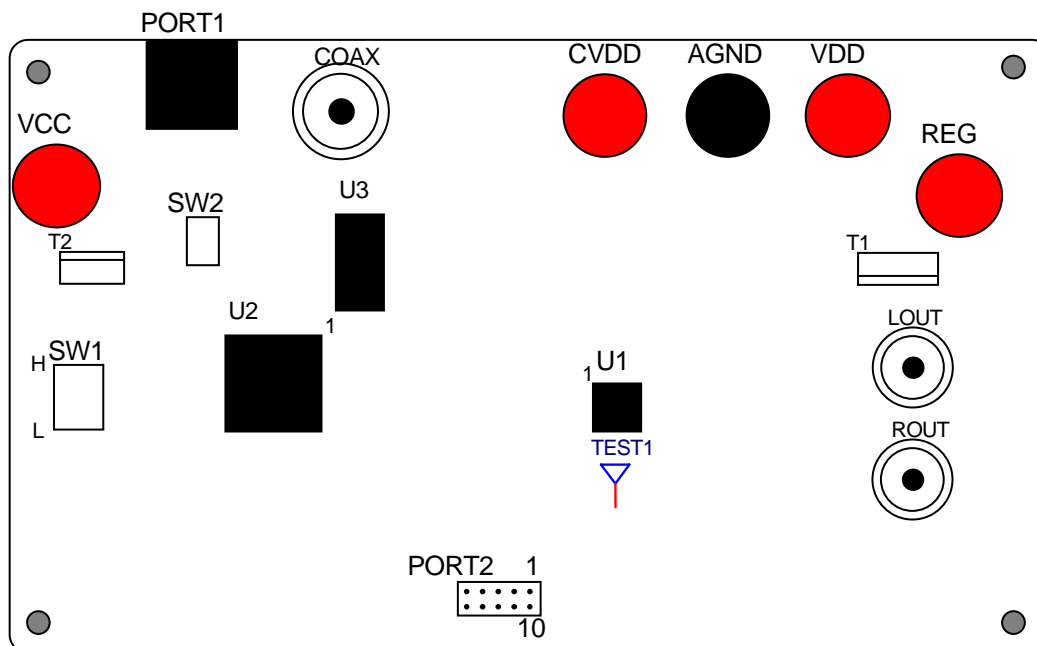

Figure 2. AKD4430-SA Outline Chart

■ Comment

- (1) LOUT, ROUT (BNC-JACK)
It is analog signal output Jack. The signal is output from LOUT/ROUT pins.
- (2) COAX, PORT1, PORT2 (Digital signal connector)
COAX (BNC-JACK): Digital signal (SPDIF, Fs: 24~48kHz) is input to the AK4115. (Default)
PORT1 (Optical Connector): Optical digital signal (SPDIF, Fs: 32~48kHz) is input to the AK4115.
PORT2 (10 pin header): The clock and data can be input and output with this connector.
- (3) REG, VDD, AGND, CVDD, VCC
These are the power supply connectors. Connect power supply with these pins.
As for the detail comments, refer to the setup of power supply in P3.
- (4) SW1, SW2 (Switch)
SW1: Setting of frequency of MCKO that is output from AK4115.
SW2: Reset of AK4115. Keep "H" during normal operation.

■ Operation sequence

- 1) Set up the power supply lines.
Each supply line should be distributed from the power supply unit.

Name of jack	Color of jack	Typ Voltage	Voltage Range	Using	Default Setting
VCC1 (Note 1)	Red	+12V	+7~+15V	AVDD, DVDD, TVDD, OVDD of AK4115 and VCC of Logic circuit (Regulator:T2)	Connected to +12V
VDD1	Red	+3.3V	+3~+3.6V	VDD of AK4430	Open
CVDD1	Red	+3.3V	+3~+3.6V	CVDD of AK4430	Open
AGND2	Black	0V	0V	Ground	Connected to GND (Should be connected)
REG (Note 2)	Red	+12V	+7V~+15V	VDD, CVDD of AK4430 (Regulator:T1)	Connected to +12V

Table 1.Set up of power supply lines

Note 1) In case of using +3.3V power supply to connect VCC1, It is possible to supply the voltage to AK4115 and the Logic circuit without using Regulator.

In this case, change to R36: Open→ Short (0 Ω); R34,R35: Short (0 Ω) → Open

Note 2) In case of using +12V power supply to connect REG, Use regulator: T1 can supply AK4430 with clean voltage. (Default)

In this case, change to R25,R44: Short (0 Ω)→ Open; R37,R43:Open→ Short (0 Ω); VDD, CVDD should be open.

- 2) DIP Switch setting:

Refer to Table 2 and Table 3

- 3) Power Down:

The AK4115 should be reset once by bringing SW2 (AK4115 PDN) “L” upon power-up.

■ Evaluation mode

1. Using DIR (Optical Link)

The DIR generates MCLK, BICK, LRCK and SDATA from the received data through optical connector (PORT1: TORX141). It is possible to evaluate the AK4430 by using CD disk.

Setting: R19: Open →470Ω; R33: short (0Ω)→Open

2. Using DIR (COAX) (Default)

The DIR generates MCLK, BICK, LRCK and SDATA from the received data through BNC connector (J3). It is possible to evaluate the AK4430 by using CD disk.

Setting: R19: Open; R33: short (0Ω); (Default)

* COAX is recommended for an evaluation of the Sound quality.

3. Supply all interface signals that include master clock via PORT2 from external equipments..

Setting: R11: 5.1Ω→Open
R12, R13, R14: 51Ω→Open
R15, R16, R17, R18: Open→51Ω or short (0Ω)

Note) The above work of removing (open) or shorting resistors need to modify the connection by soldering.

■ Setting of DIP switch

[SW1]: AK4115 setting

No.	Pin	OFF (“L”)	ON (“H”)	Default の状態
1	OCKS0	AK4115’s Master Clock setting Look Table 3		L
2	OCKS1			H

Table 2. SW1 setting

OCKS1	OCKS0	MCLK Frequency	Default
0	0/1	256fs @ fs=96kHz	
1	0	512fs @ fs=48kHz	
1	1	128fs @ fs=192kHz	

Table 3. MCLK clock setting

■ Setting of SW2 switch

[SW2](PDN): Reset of AK4115. Keep “H” during normal operation.

Measurement Results

[Measurement condition]

- Measurement unit : Audio Precision System two Cascade (AP2)
- MCLK : 512fs, 256fs, 128fs
- BICK : 64fs
- fs : 44.1kHz, 96kHz, 192kHz
- Bit : 24bit
- Power Supply : VDD=CVDD=3.3V
- Interface : DIR
- Temperature : Room

Table Data

fs=44.1kHz

Parameter	Input signal	Measurement filter	Lch	Rch
S/(N+D)	1kHz, 0dB	20kLPF	91.8	92.2
DR	1kHz, -60dB	20kLPF SPCL, A-weighted	104.5	104.5
S/N	“0” data	20kLPF SPCL, A-weighted	104.7	104.7

fs=96kHz

Parameter	Input signal	Measurement filter	Lch	Rch
S/(N+D)	1kHz, 0dB	40kLPF	91.4	91.9
DR	1kHz, -60dB	40kLPF SPCL, A-weighted	104.4	104.4
S/N	“0” data	40kLPF SPCL, A-weighted	104.6	104.6

fs=192kHz

Parameter	Input signal	Measurement filter	Lch	Rch
S/(N+D)	1kHz, 0dB	40kLPF	89.5	89.9
DR	1kHz, -60dB	40kLPF SPCL, A-weighted	104.0	103.9
S/N	“0” data	40kLPF SPCL, A-weighted	104.5	104.4

Plot Data

fs=44.1kHz

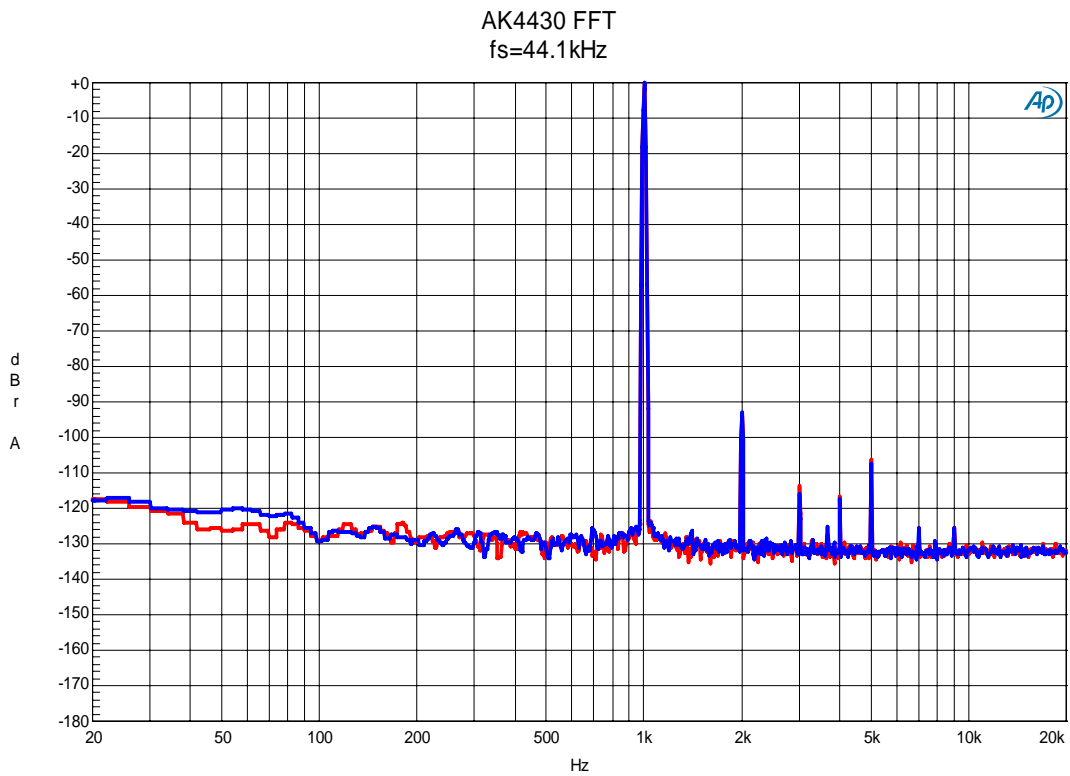

Figure 3. FFT (0dB Input ,fin=1kHz)

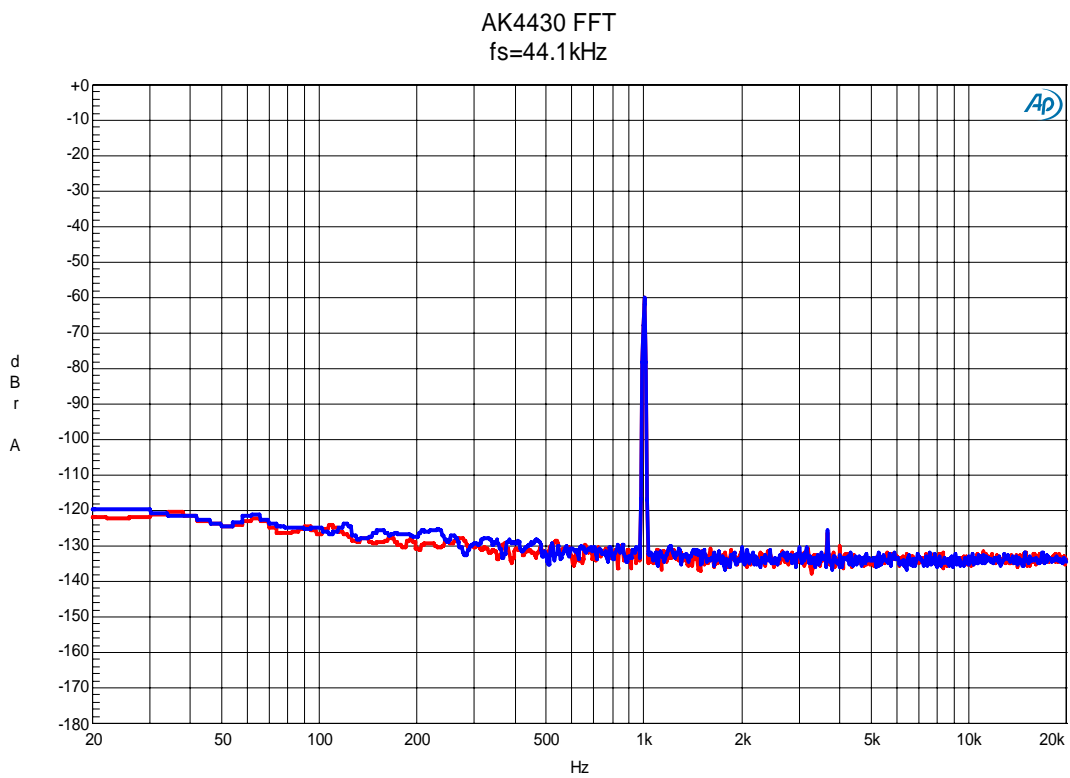

Figure 4. FFT (-60dB Input, fin=1kHz)

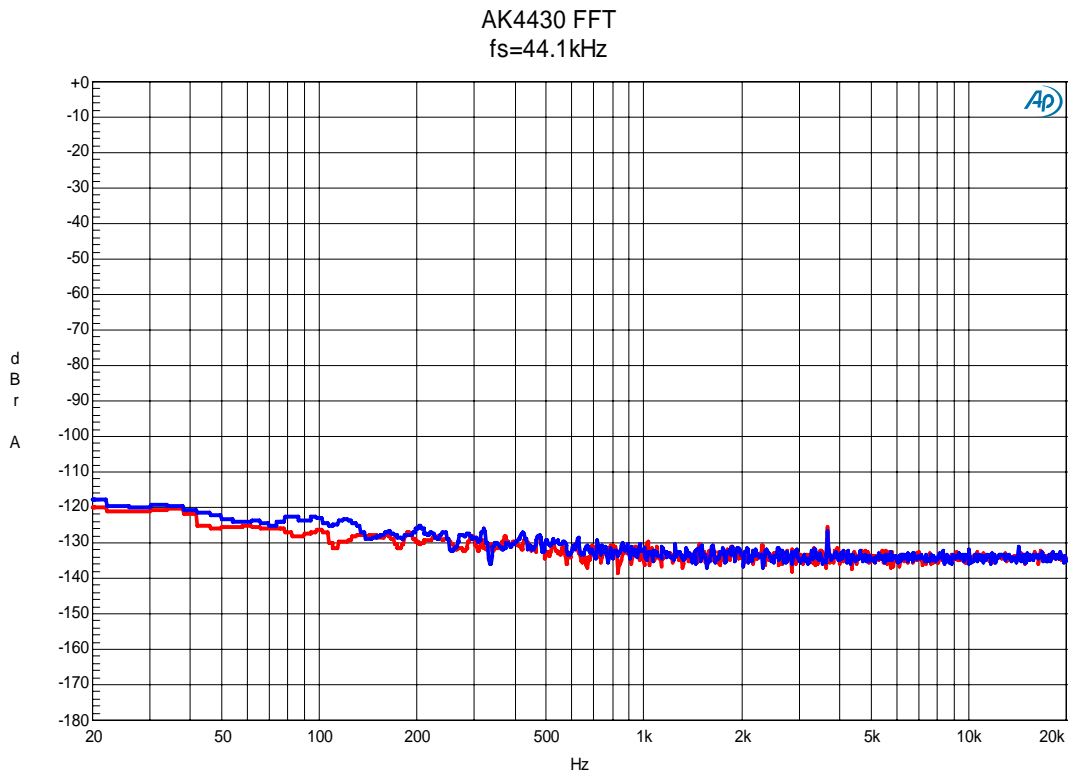

Figure 5. FFT (No Signal)

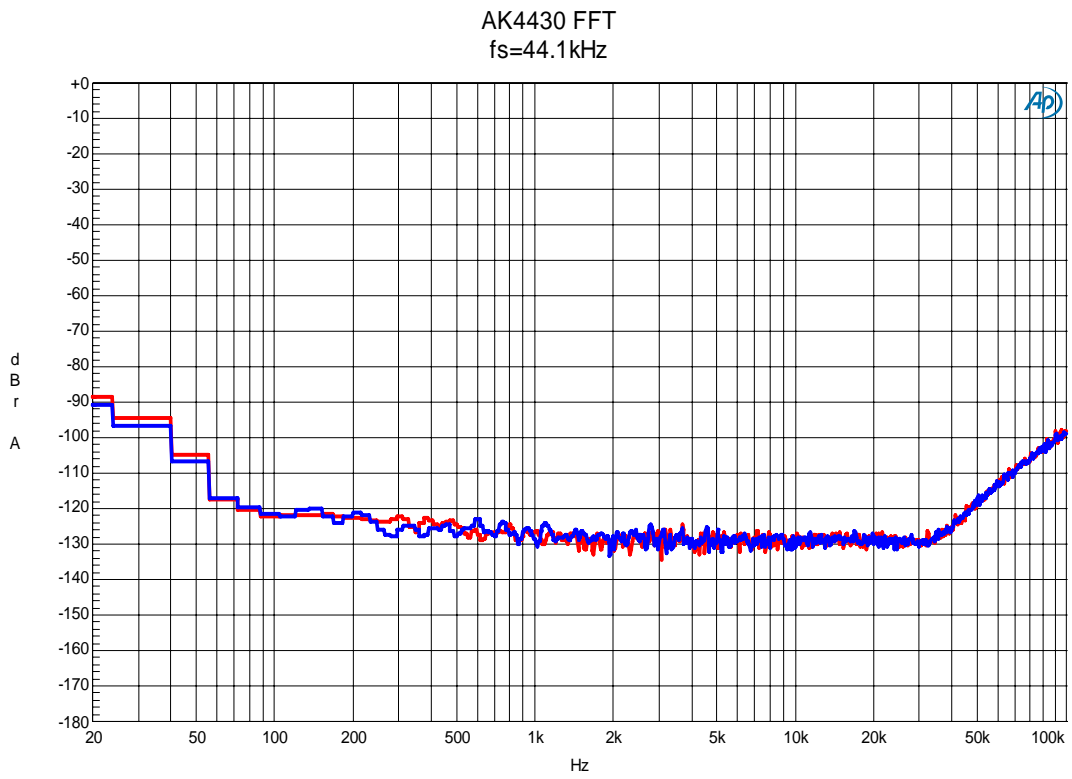

Figure 6. FFT (Out of Band Noise)

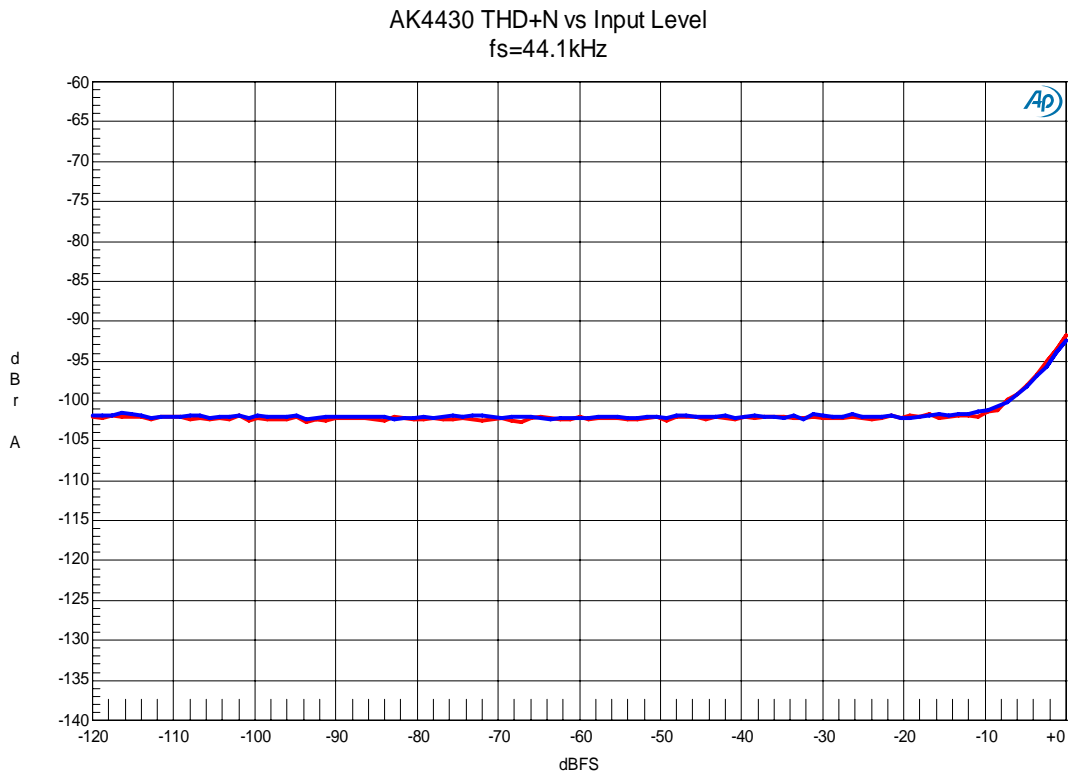

Figure 7. THD + N vs Input Level (fin=1kHz)

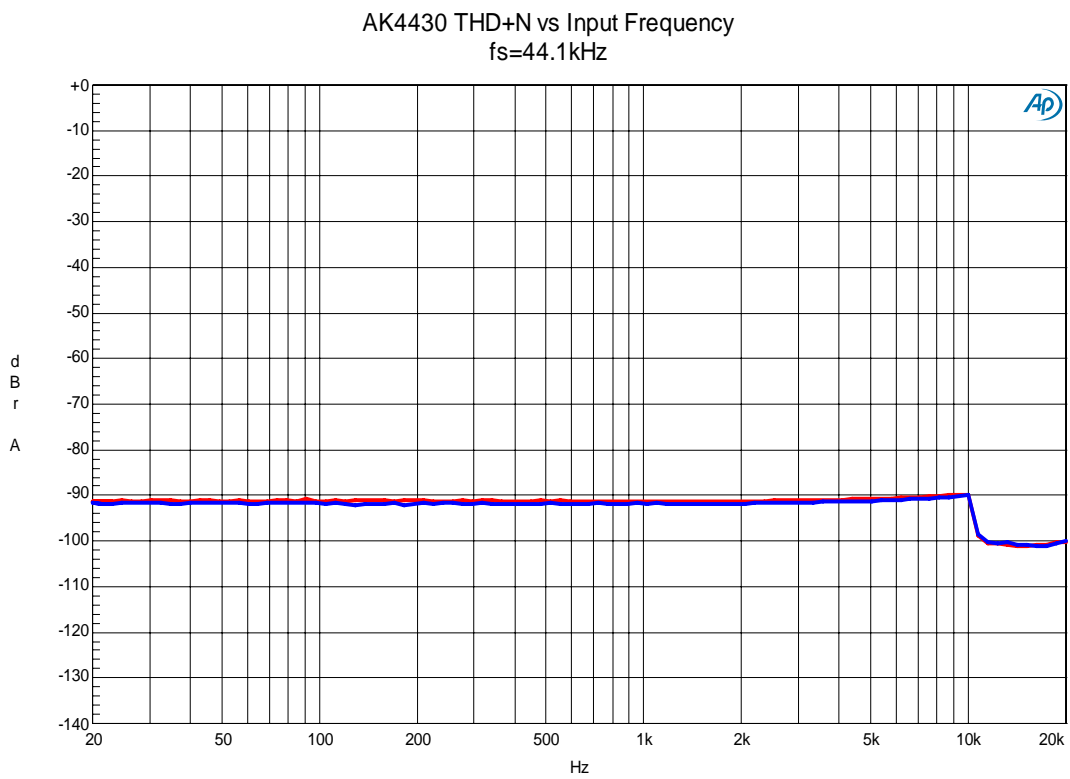

Figure 8. THD + N vs Input Frequency (0dB Input)

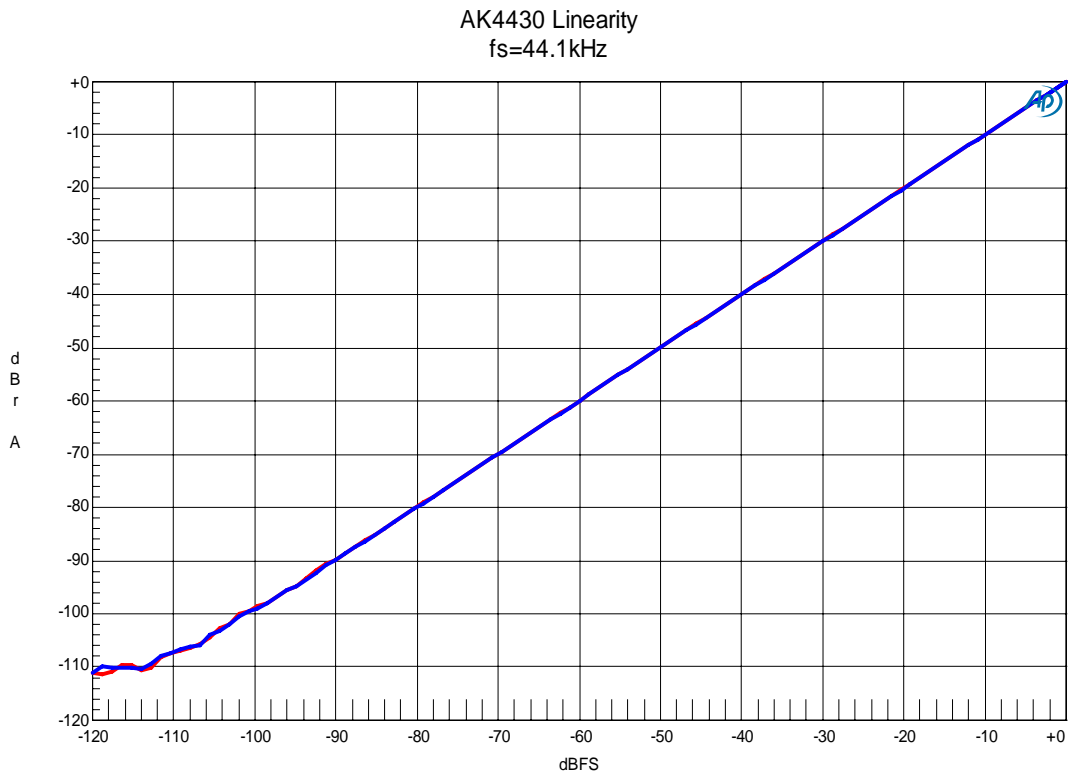

Figure 9. Linearity (fin=1kHz)

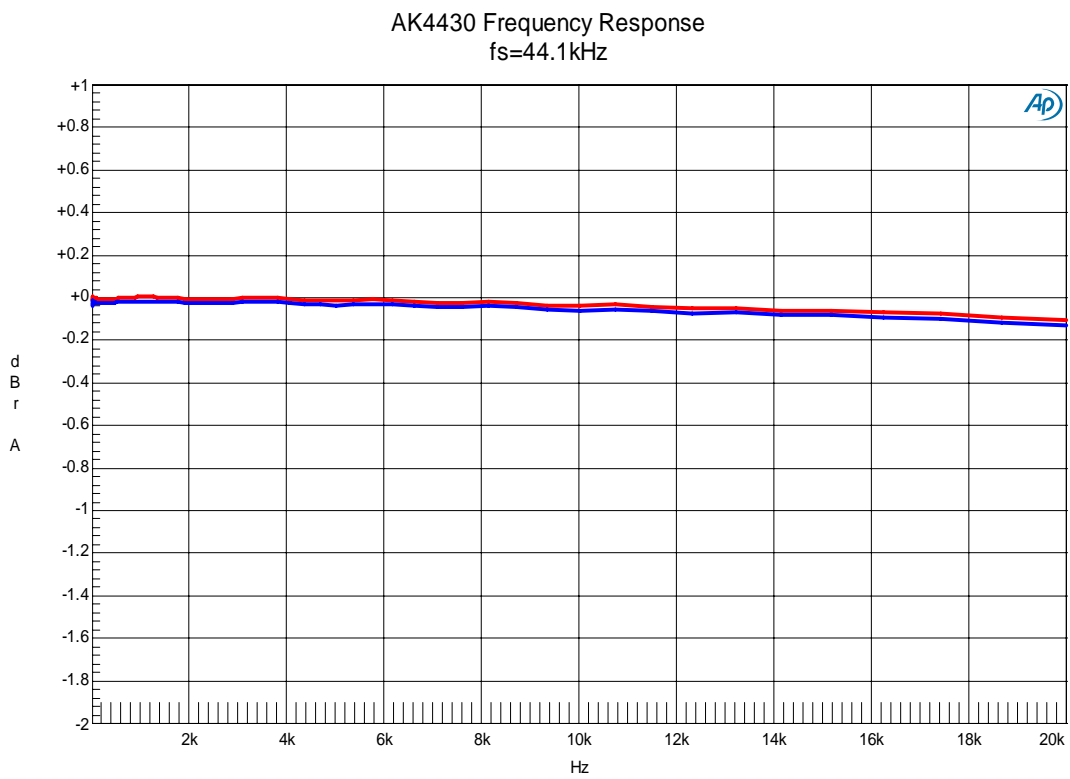

Figure 10. Frequency Response (0dB Input)

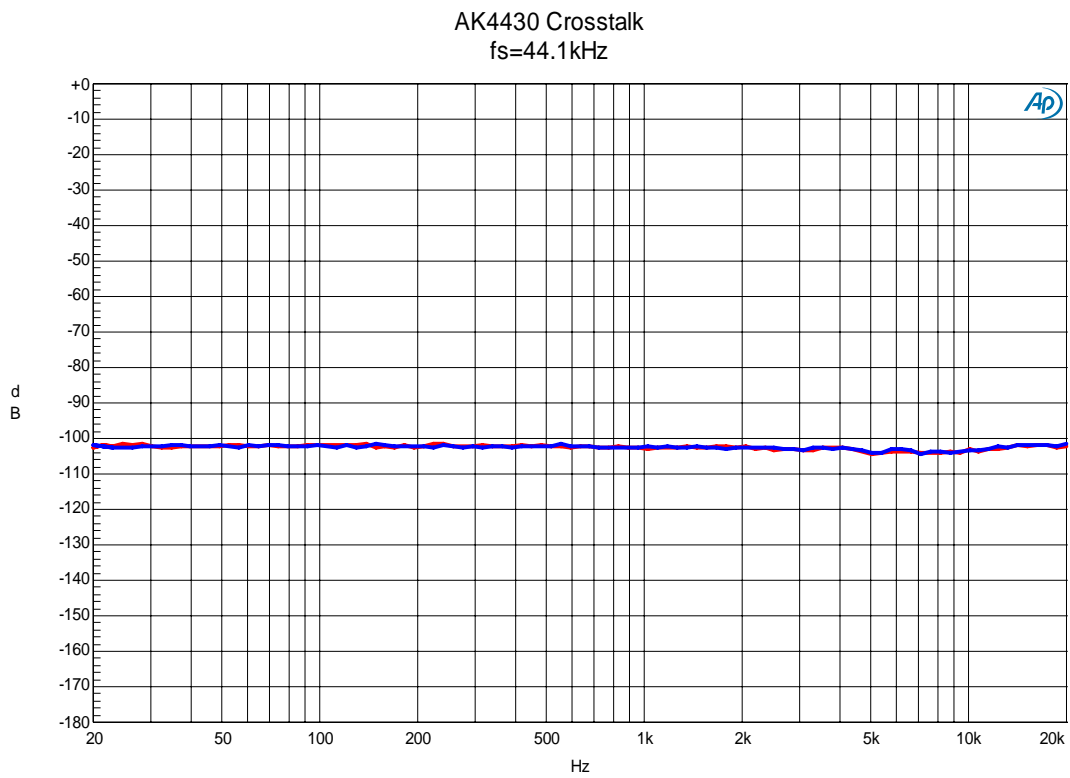

Figure 11. Crosstalk (0dB Input)

fs=96kHz

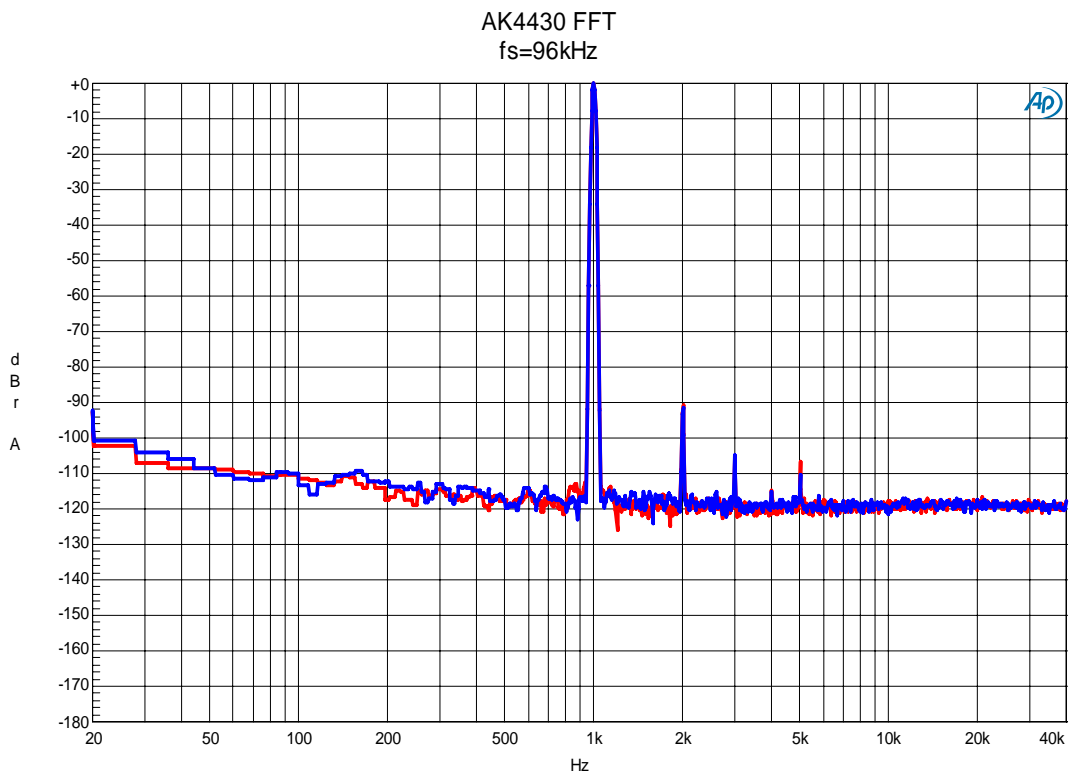

Figure 12. FFT (0dB Input, fin=1kHz)

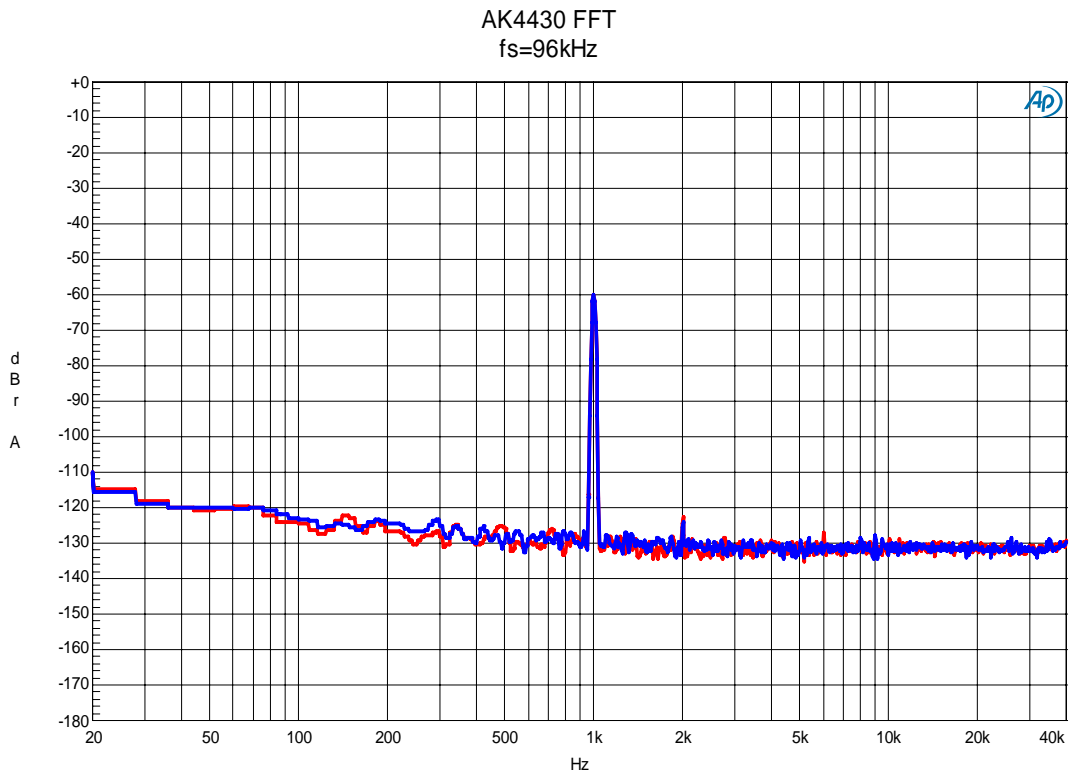

Figure 13. FFT (-60dB Input, fin=1kHz)

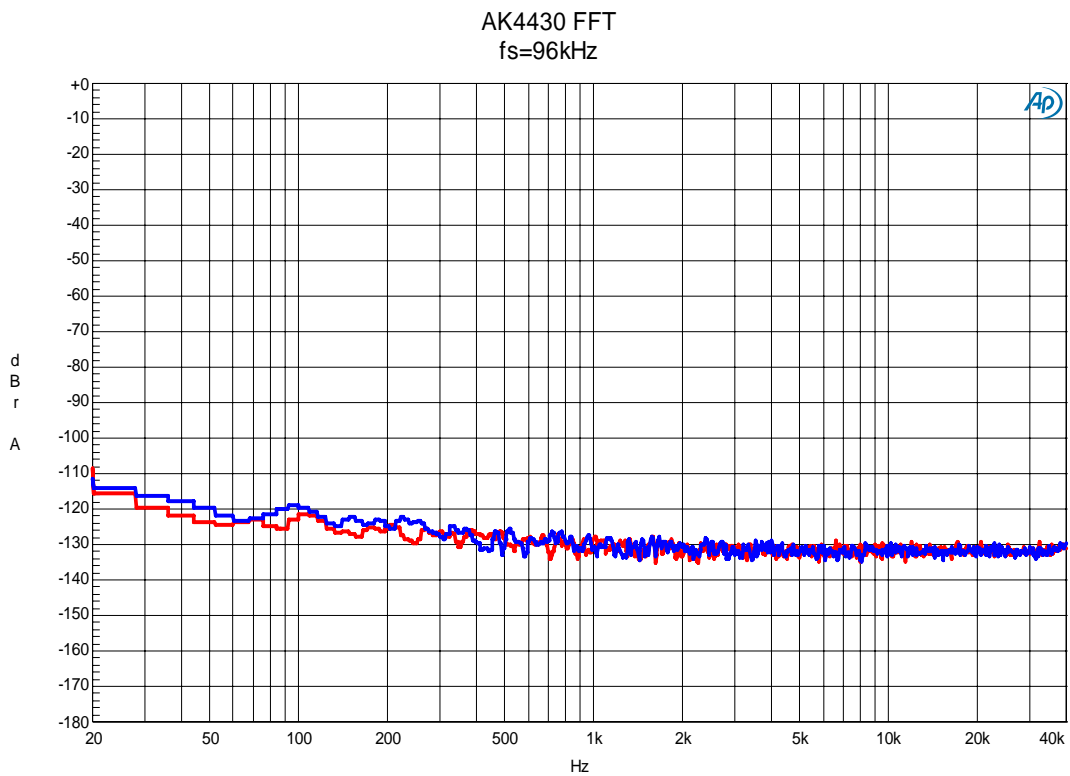

Figure 14.FFT (No Signal)

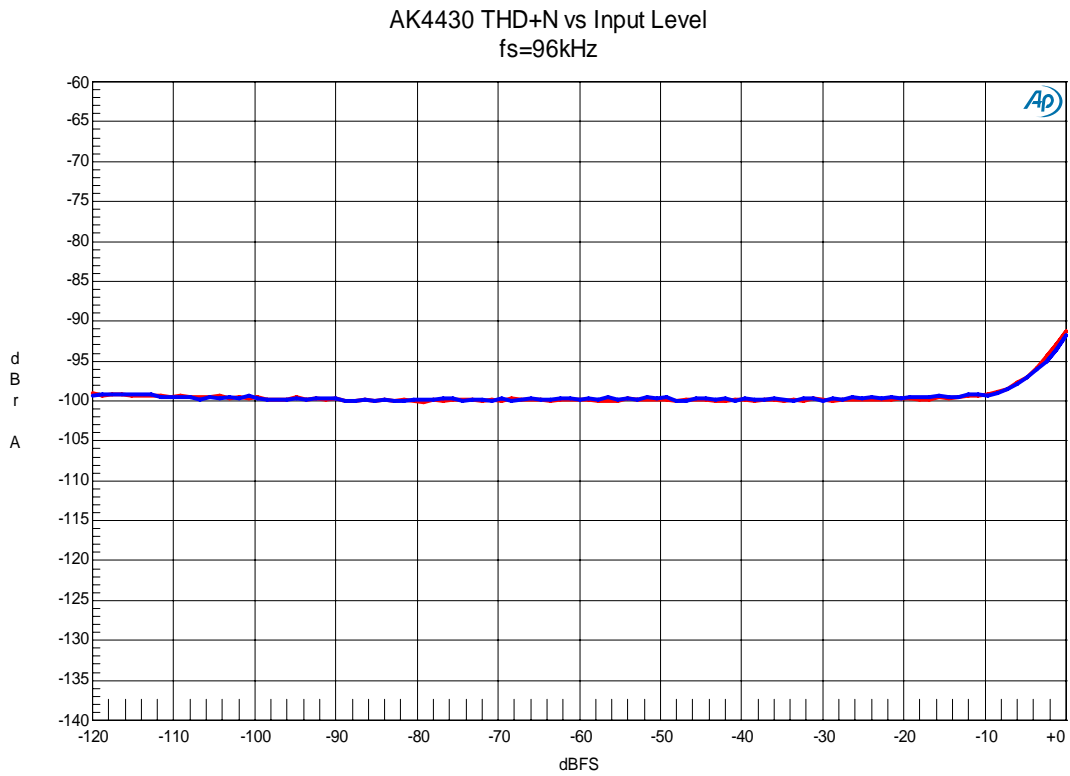

Figure 15. THD+N vs Input Level (fin=1kHz)

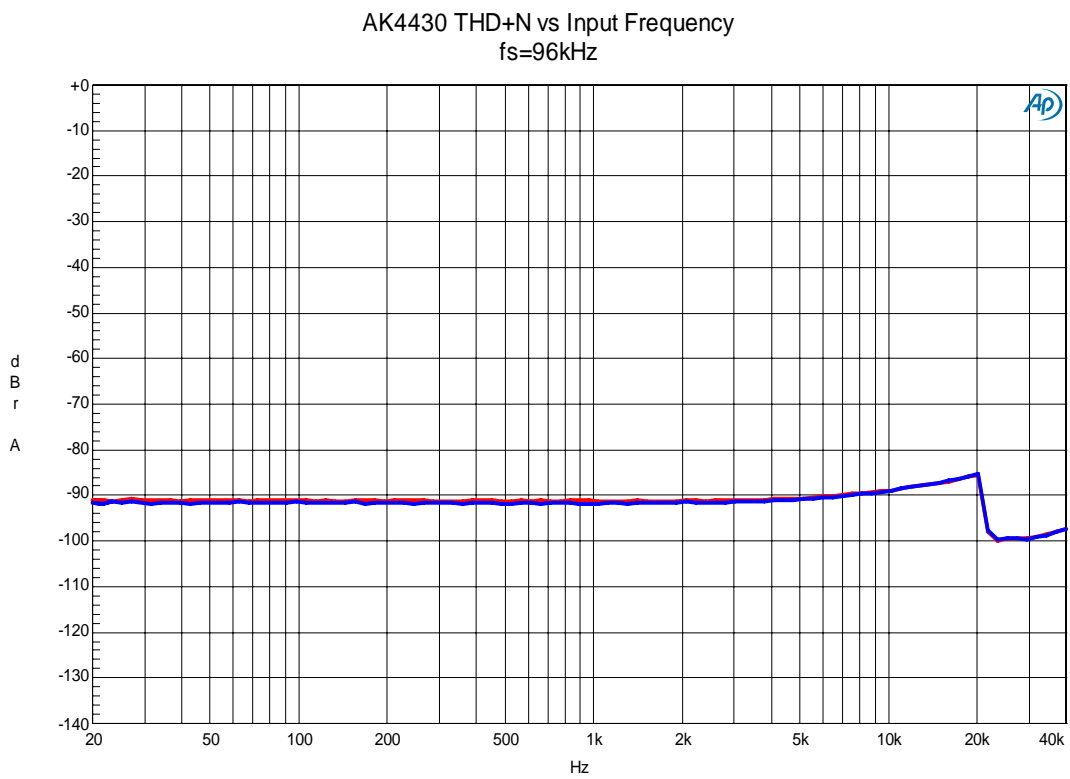

Figure 16. THD+N vs Input Frequency (0dB Input)

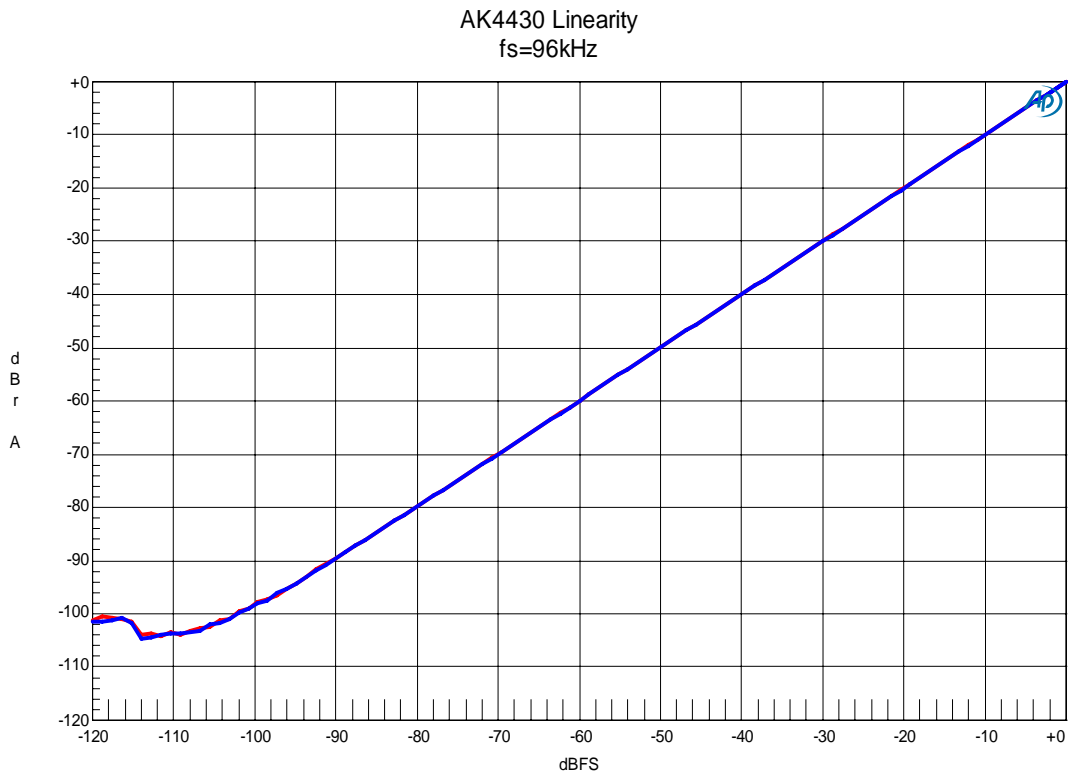

Figure 17. Linearity (f_{in}=1kHz)

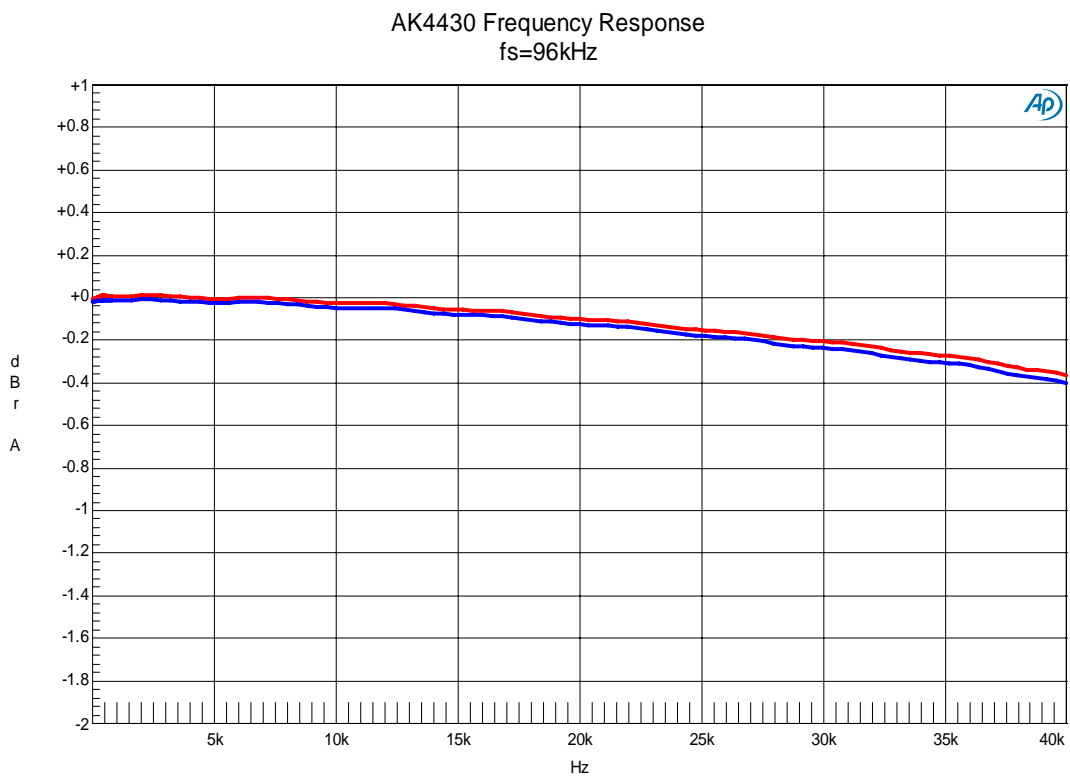

Figure 18. Frequency Response (0dB Input)

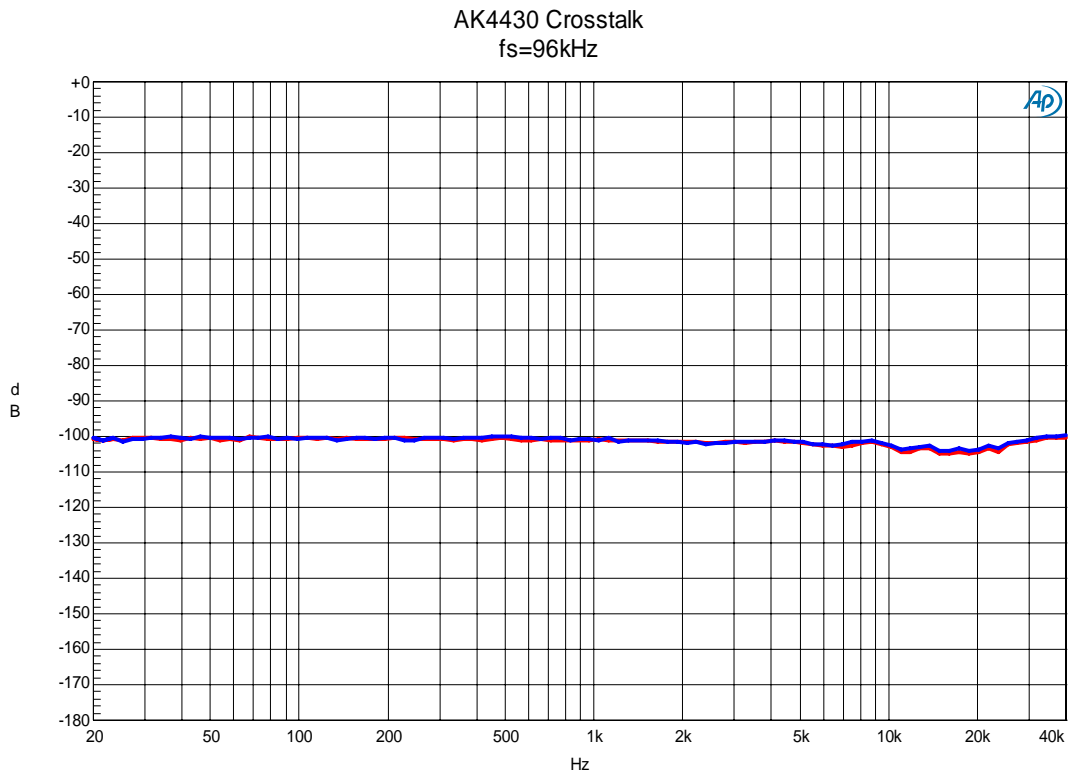

Figure 19. Crosstalk (0dB Input)

fs=192kHz

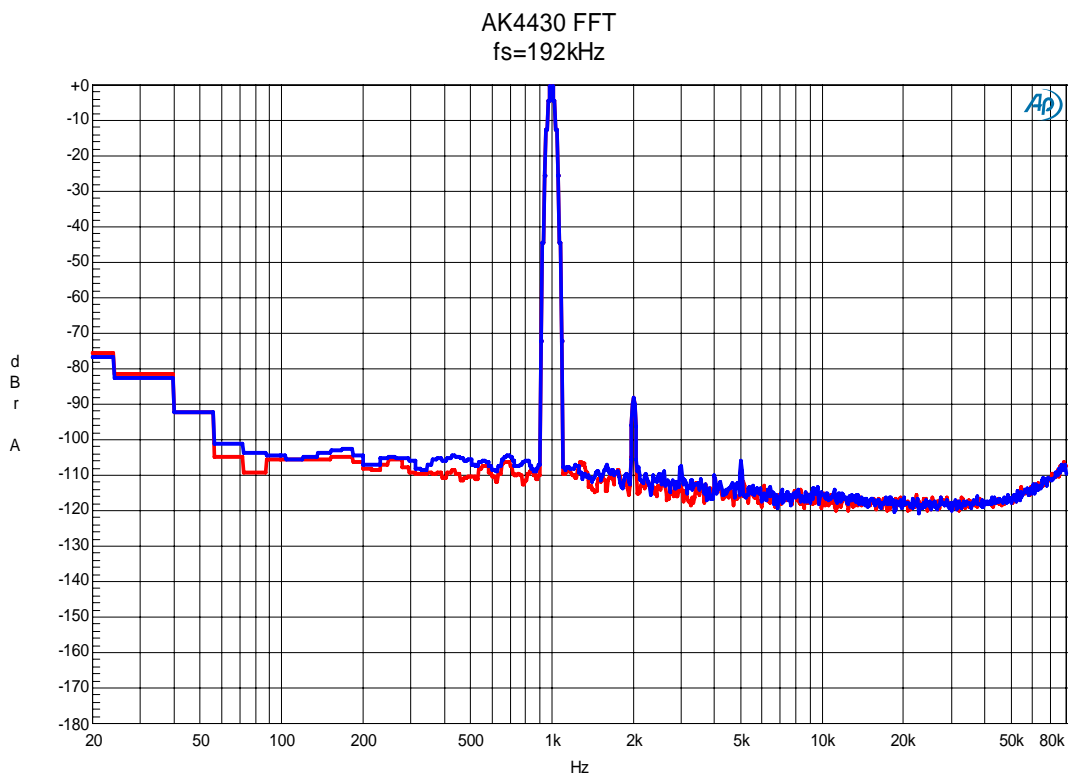

Figure 20.FFT (0dB Input, fin=1kHz)

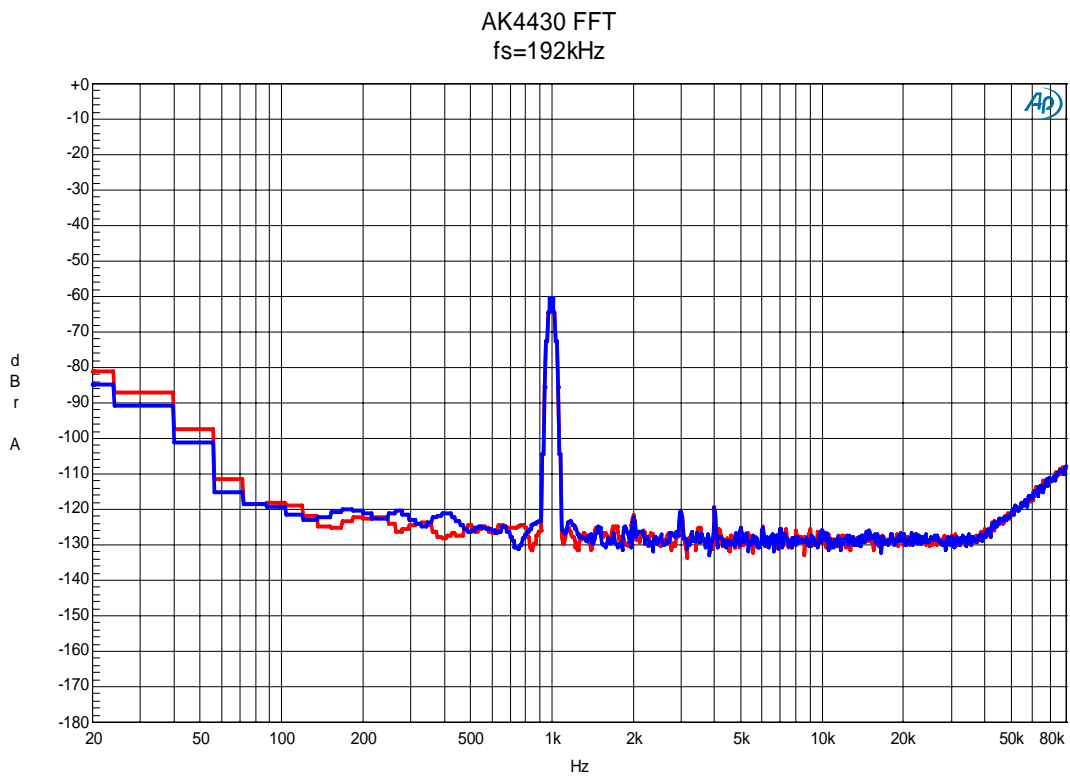

Figure 21.FFT (-60dB Input, $f_{in}=1\text{kHz}$)

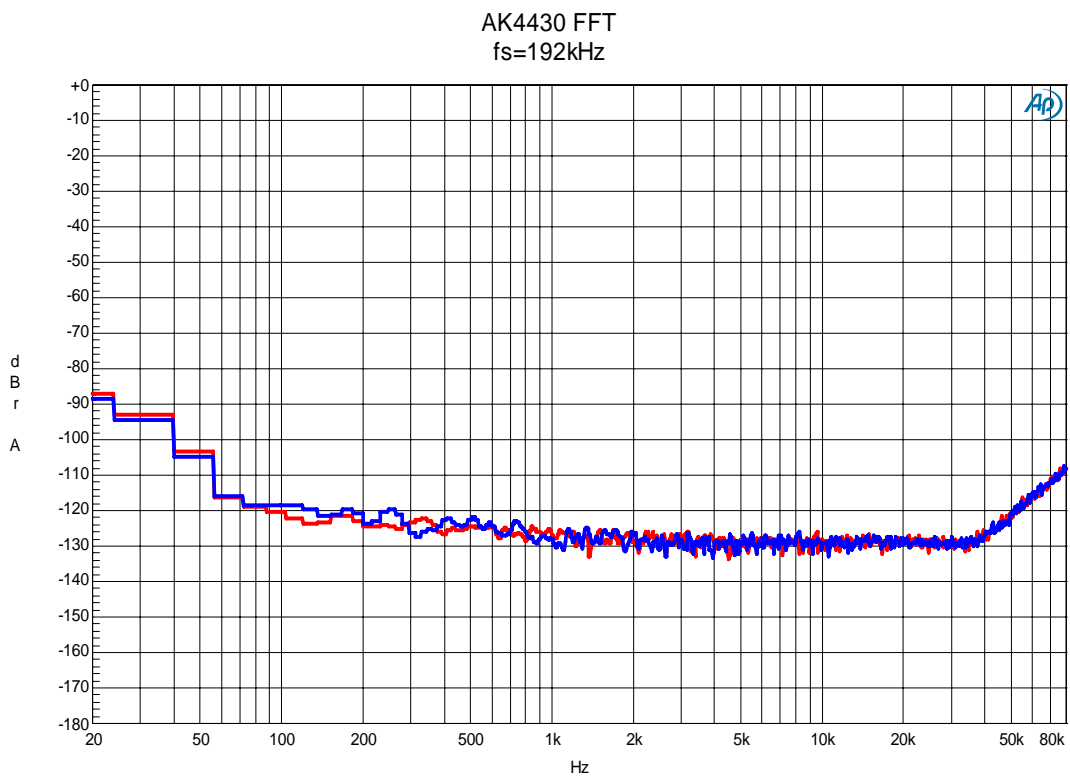

Figure 22.FFT (No Signal)

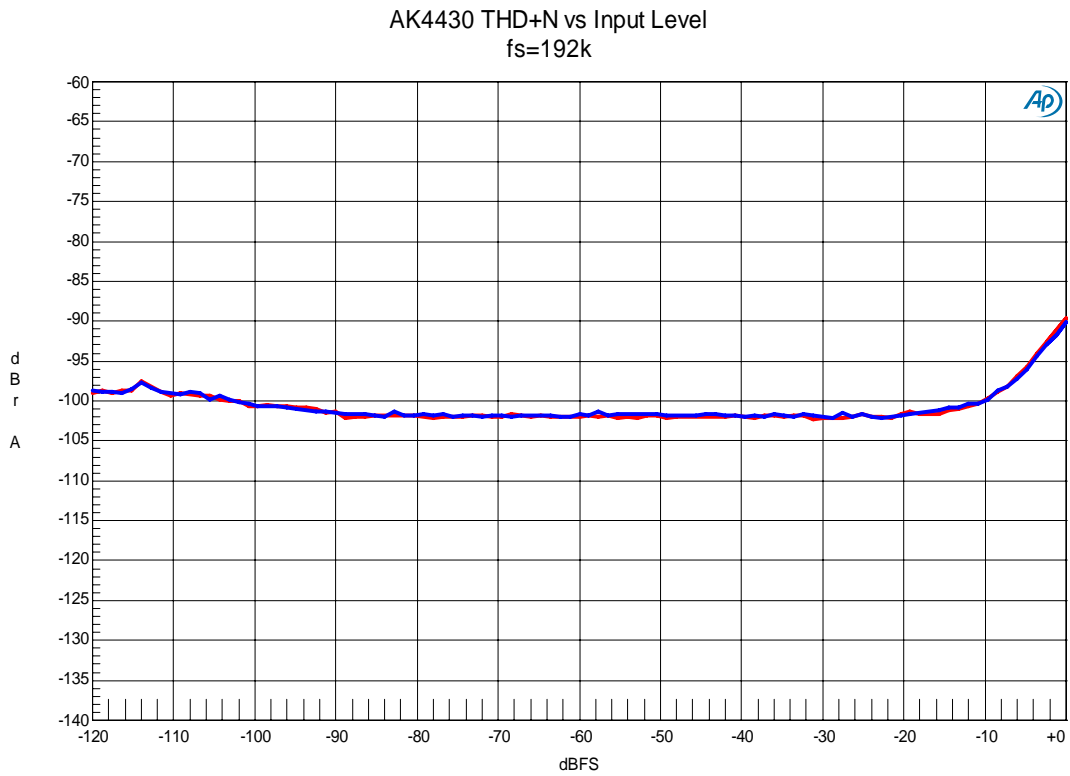

Figure 23. THD+N vs Input Level (f_{in}=1kHz)

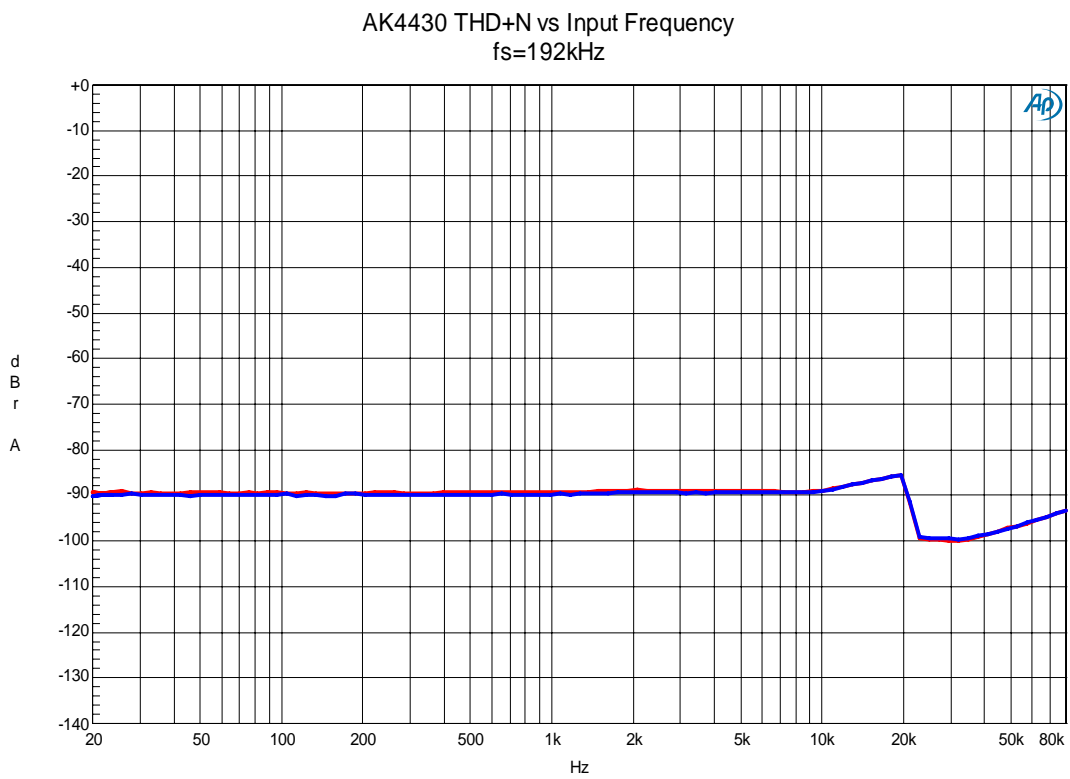

Figure 24. THD+N vs Input Frequency (0dB Input)

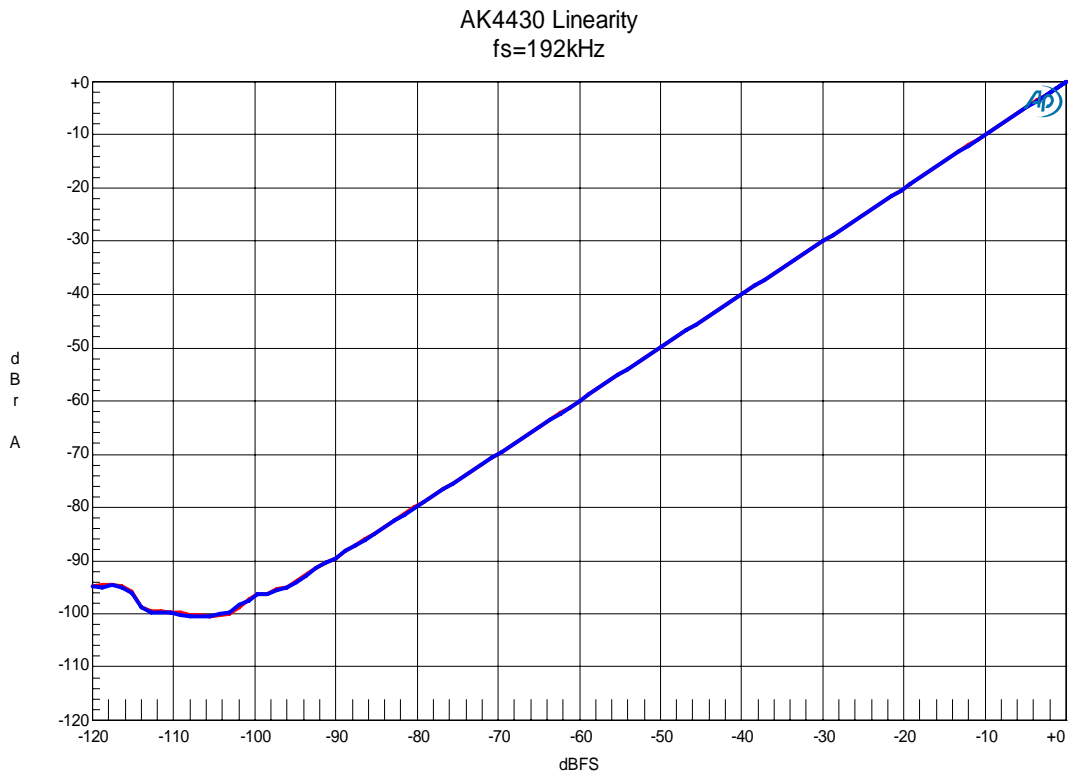

Figure 25. Linearity (f_{in}=1kHz)

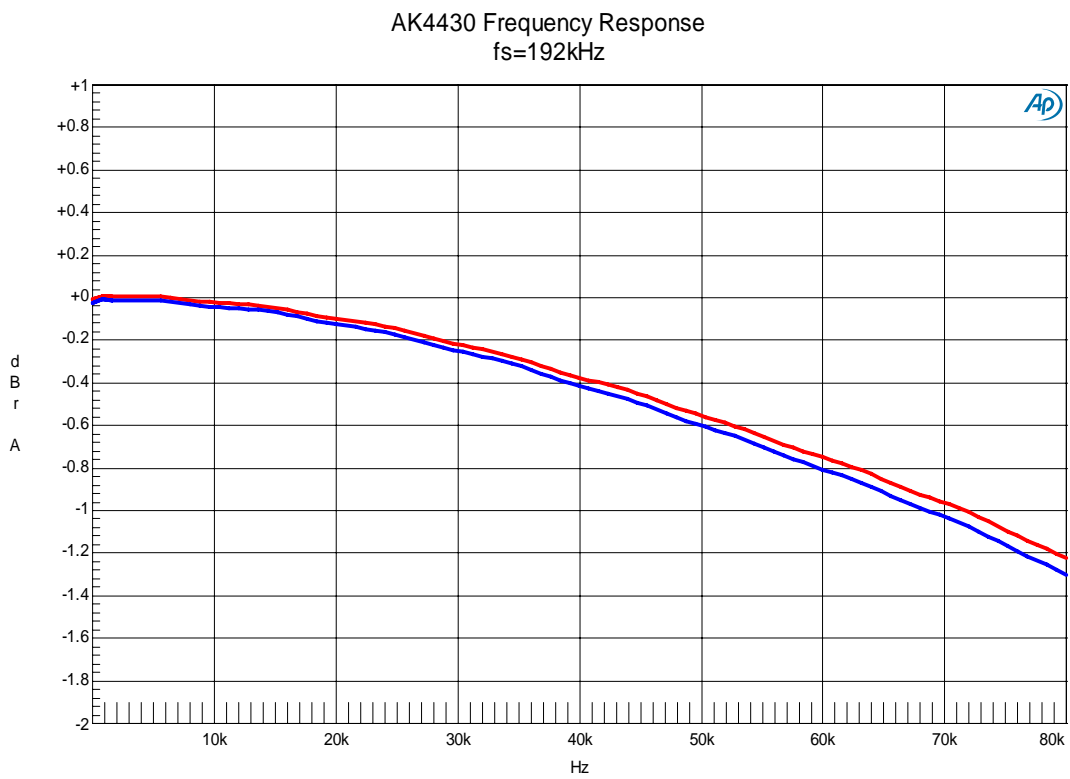

Figure 26. Frequency Response (0dB Input)

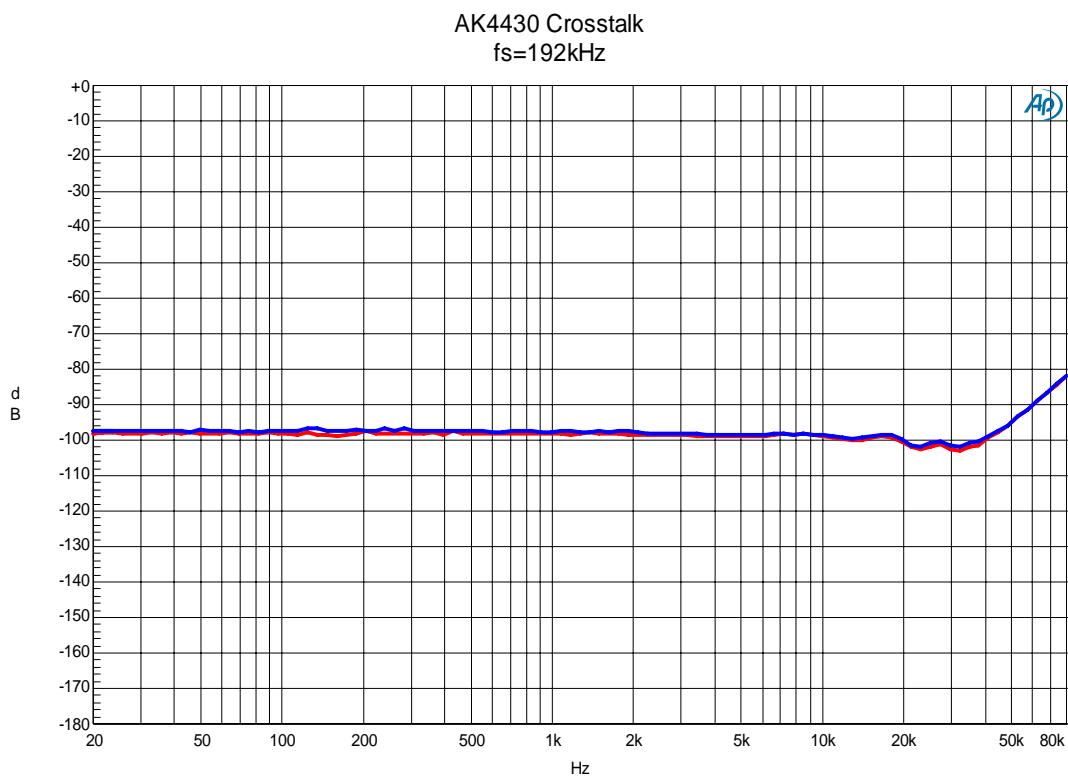

Figure 27. Crosstalk (0dB Input)

REVISION HISTORY

Date (yy/mm/dd)	Manual Revision	Board Revision	Reason	Page	Contents
09/11/04	KM101700	0	First Edition		
10/04/13	KM101701	1	Modification	5-18	Update of measurement results and Plots.

IMPORTANT NOTICE

- These products and their specifications are subject to change without notice.
When you consider any use or application of these products, please make inquiries the sales office of Asahi Kasei Microdevices Corporation (AKM) or authorized distributors as to current status of the products.
- AKM assumes no liability for infringement of any patent, intellectual property, or other rights in the application or use of any information contained herein.
- Any export of these products, or devices or systems containing them, may require an export license or other official approval under the law and regulations of the country of export pertaining to customs and tariffs, currency exchange, or strategic materials.
- AKM products are neither intended nor authorized for use as critical components_{Note1)} in any safety, life support, or other hazard related device or system_{Note2)}, and AKM assumes no responsibility for such use, except for the use approved with the express written consent by Representative Director of AKM. As used here:
 - Note1) A critical component is one whose failure to function or perform may reasonably be expected to result, whether directly or indirectly, in the loss of the safety or effectiveness of the device or system containing it, and which must therefore meet very high standards of performance and reliability.
 - Note2) A hazard related device or system is one designed or intended for life support or maintenance of safety or for applications in medicine, aerospace, nuclear energy, or other fields, in which its failure to function or perform may reasonably be expected to result in loss of life or in significant injury or damage to person or property.
- It is the responsibility of the buyer or distributor of AKM products, who distributes, disposes of, or otherwise places the product with a third party, to notify such third party in advance of the above content and conditions, and the buyer or distributor agrees to assume any and all responsibility and liability for and hold AKM harmless from any and all claims arising from the use of said product in the absence of such notification.

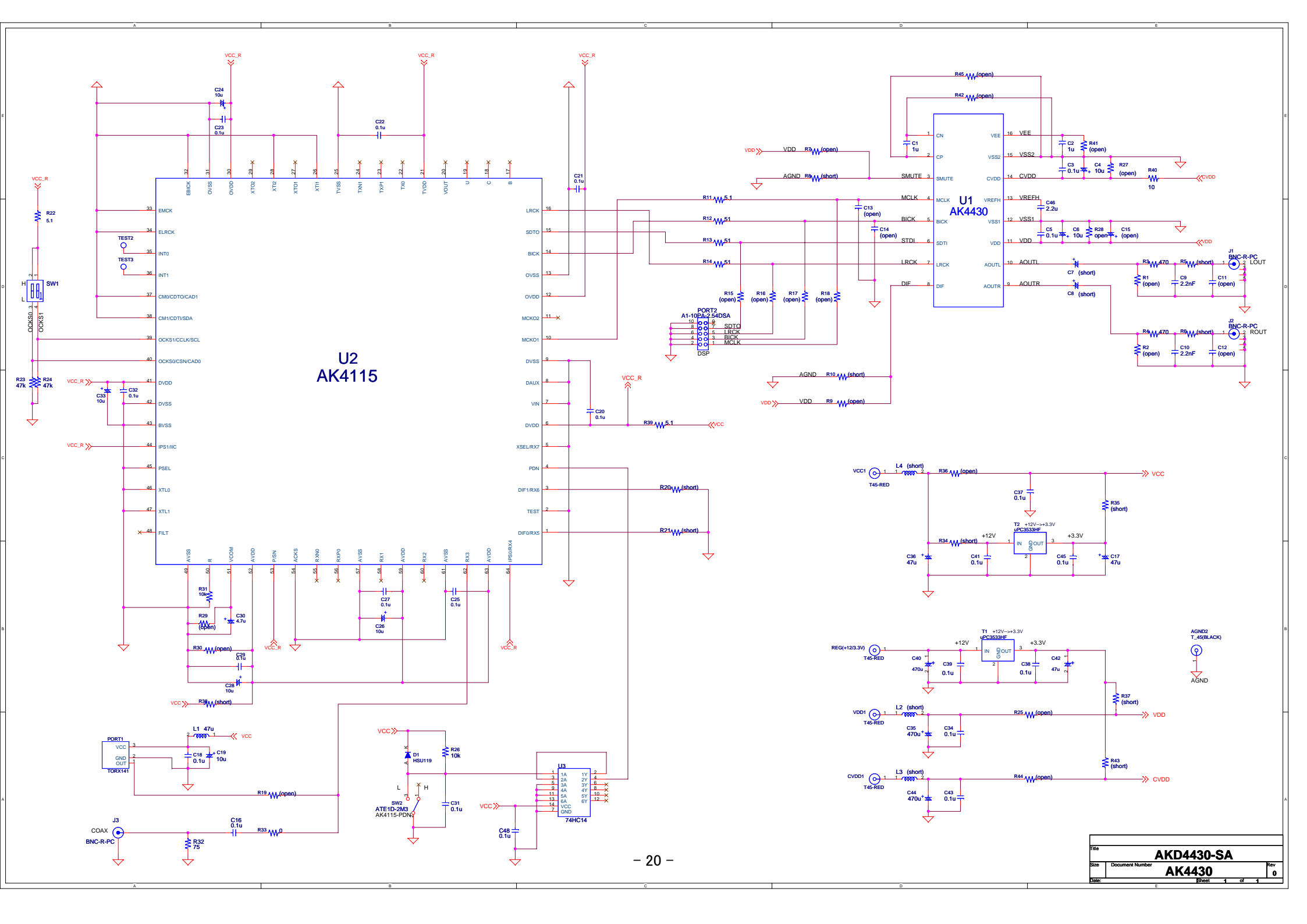

**U2
AK4115**

**U1
AK4430**

File		
AKD4430-SA		
Size	Document Number	Rev
	AK4430	0
Date:	Sheet 1 of 1	