

**SURFACE MOUNT SCHOTTKY BARRIER RECTIFIER**

**VOLTAGE RANGE 80 to 100 Volts CURRENT 1.0 Ampere**

**FEATURES**

- \* Low switching noise
- \* Low forward voltage drop
- \* High current capability
- \* High switching capability
- \* High surge capability
- \* High reliability

**MECHANICAL DATA**

- \* Case: Molded plastic
- \* Epoxy: Device has UL flammability classification 94V-0
- \* Lead: MIL-STD-202E method 208C guaranteed
- \* Metallurgically bonded construction
- \* Mounting position: Any
- \* Weight: 0.098 gram

**MAXIMUM RATINGS AND ELECTRICAL CHARACTERISTICS**

Ratings at 25 °C ambient temperature unless otherwise specified.  
 Single phase, half wave, 60 Hz, resistive or inductive load.  
 For capacitive load, derate current by 20%.

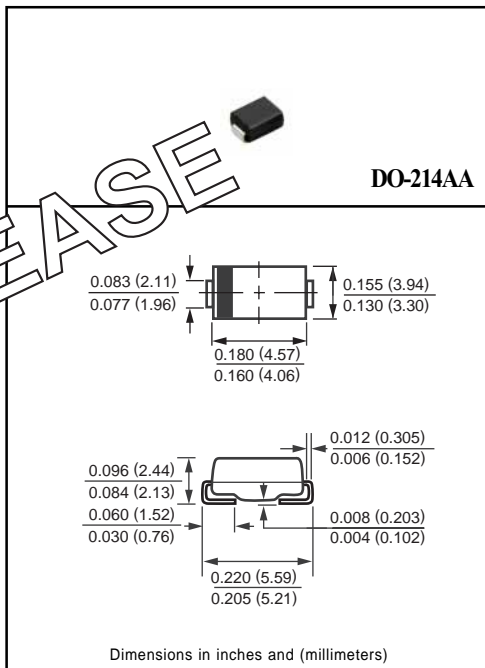

**MAXIMUM RATINGS** (At TA = 25°C unless otherwise noted)

RATINGS	SYMBOL	FM180B	FM1100B	UNITS
Maximum Recurrent Peak Reverse Voltage	VRRM	80	100	Volts
Maximum RMS Voltage	VRMS	56	70	Volts
Maximum DC Blocking Voltage	VDC	80	100	Volts
Maximum Average Forward Rectified Current at Derating Lead Temperature	IO	1.0		Amps
Peak Forward Surge Current 8.3 ms single half sine-wave superimposed on rated load (JEDEC method)	IFSM	40		Amps
Typical Thermal Resistance (Note 1)	RθJA	57		°C/W
Typical Junction Capacitance (Note 2)	CJ	110		pF
Operating Temperature Range	TJ	150		°C
Storage Temperature Range	TSTG	-55 to + 150		°C

**ELECTRICAL CHARACTERISTICS** (At TA = 25°C unless otherwise noted)

CHARACTERISTICS	SYMBOL	FM180B	FM1100B	UNITS
Maximum Instantaneous Forward Voltage at 1.0A DC	VF	.85		Volts
Maximum Average Reverse Current at Rated DC Blocking Voltage	IR	@ TA = 25°C	1.0	uA
		@ TJ = 125°C	0.5	mA

NOTES : 1. Thermal Resistance (Junction to Ambient): Vertical PC Board Mounting, 0.5" (12.7mm) Lead Length.  
 2. Measured at 1 MHz and applied reverse voltage of 4.0 volts.

# RATING AND CHARACTERISTIC CURVES ( FM180B THRU FM1100B )

FIG. 1 - TYPICAL FORWARD CURRENT DERATING CURVE

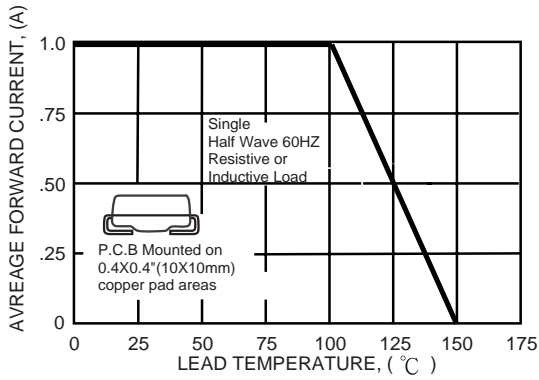

FIG. 2 - TYPICAL INSTANTANEOUS FORWARD CHARACTERISTICS

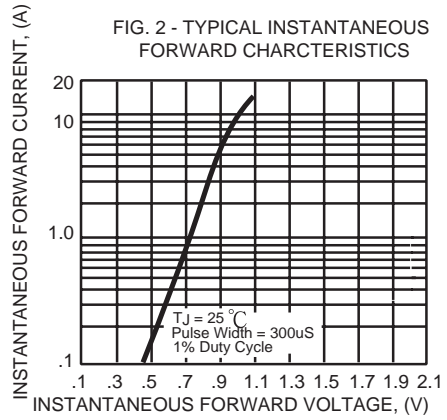

FIG. 3A - TYPICAL REVERSE CHARACTERISTICS

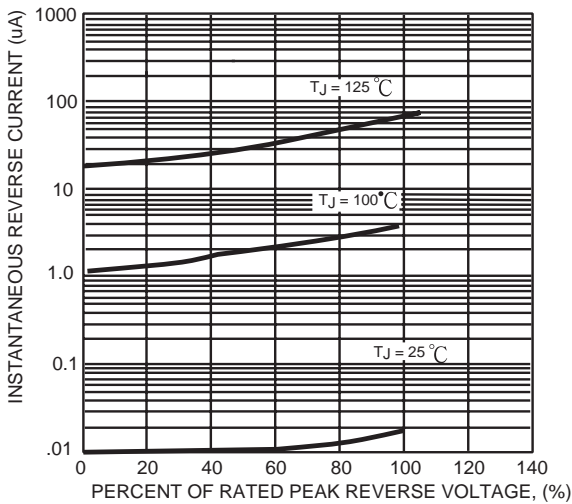

FIG. 4 - MAXIMUM NON-REPETITIVE FORWARD SURGE CURRENT

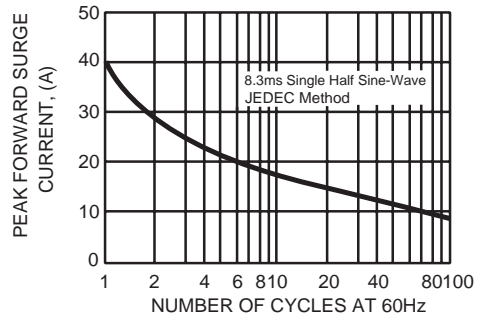
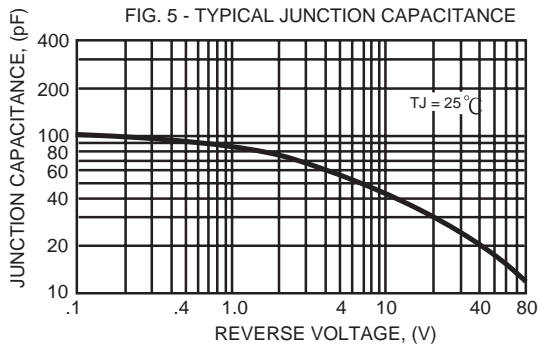
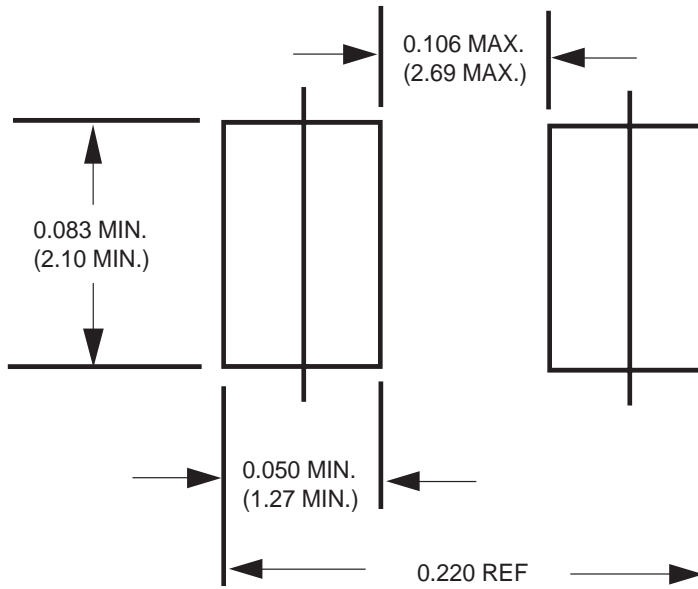

FIG. 5 - TYPICAL JUNCTION CAPACITANCE



## Mounting Pad Layout



Dimensions in inches and (millimeters)