

**PLEASE CHECK WWW.MOLEX.COM FOR LATEST PART INFORMATION**

**Part Number:** **0739424000**  
**Status:** **Active**  
**Overview:** hdm  
**Description:** 2.00mm (.079") Pitch HDM® Board-to-Board Backplane Header, Vertical, Solder Tail, Open End, 72 Circuits

**Documents:**

[3D Model](#) [RoHS Certificate of Compliance \(PDF\)](#)  
[Drawing \(PDF\)](#)

**Agency Certification**

CSA LR19980  
 UL E29179

**General**

Product Family Backplane Connectors  
 Series 73942  
 Application Backplane  
 Comments Solder Tail  
 Component Type PCB Header  
 Overview hdm  
 Product Name HDM®  
 Style N/A

**Physical**

Circuits (Loaded) 72  
 Circuits (maximum) 72  
 Color - Resin Black, Natural  
 Durability (mating cycles max) 250  
 First Mate / Last Break No  
 Flammability 94V-0  
 Guide to Mating Part No  
 Keying to Mating Part None  
 Material - Metal Phosphor Bronze  
 Material - Plating Mating Gold  
 Material - Plating Termination Tin  
 Material - Resin High Temperature Thermoplastic  
 Number of Columns 12  
 Number of Pairs Open Pin Field  
 Number of Rows 6  
 Orientation Vertical  
 PC Tail Length (in) 0.118 In  
 PC Tail Length (mm) 3.00 mm  
 PCB Retention None  
 PCB Thickness Recommended (in) 0.098 In  
 PCB Thickness Recommended (mm) 2.50 mm  
 Packaging Type Tube  
 Pitch - Mating Interface (in) 0.079 In  
 Pitch - Mating Interface (mm) 2.00 mm  
 Plating min: Mating (µin) 30  
 Plating min: Mating (µm) 0.75  
 Plating min: Termination (µin) 100  
 Plating min: Termination (µm) 2.5  
 Stackable Yes  
 Surface Mount Compatible (SMC) Yes  
 Temperature Range - Operating -55°C to +105°C

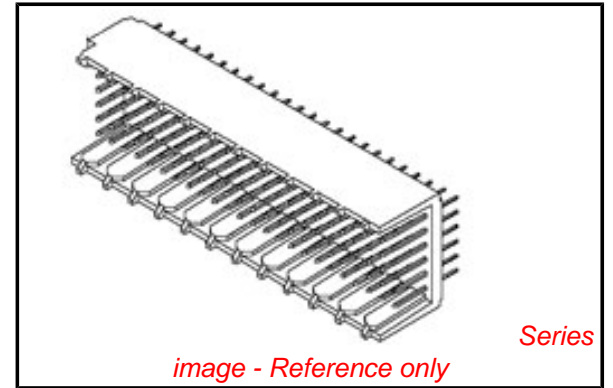

**EU RoHS**

**ELV and RoHS  
 Compliant  
 REACH SVHC  
 Not Reviewed  
 Halogen-Free  
 Status  
 Not Reviewed**

**China RoHS**



**Need more information on product  
 environmental compliance?**

Email [productcompliance@molex.com](mailto:productcompliance@molex.com)  
 For a multiple part number RoHS Certificate of Compliance, [click here](#)

Please visit the [Contact Us](#) section for any non-product compliance questions.

**Search Parts in this Series**

[73942Series](#)

**Mates With**

[73632](#) HDM PLUS® Board-to-Board Daughtercard Receptacle. [73780](#) HDM® Board-to-Board Daughtercard Receptacle

**Application Tooling | FAQ**

*Tooling specifications and manuals are found by selecting the products below. Crimp Height Specifications are then contained in the Application Tooling Specification document.*

**Global**

| Description      | Product #                  |
|------------------|----------------------------|
| HDM® Backplane   | <a href="#">0621001400</a> |
| Insertion Signal |                            |
| Contact Tool     |                            |
| Extraction Tool  | <a href="#">0621001000</a> |

Termination Interface: Style Through Hole

**Electrical**

Current - Maximum per Contact 1A  
Data Rate 1.0 Gbps  
Voltage - Maximum 250V AC

**Material Info**

**Reference - Drawing Numbers**

Packaging Specification PK-70873-0818  
Sales Drawing SD-73942-001

HDM and High Density Metric are trademarks of Amphenol Corporation

This document was generated on 05/14/2010

**PLEASE CHECK [WWW.MOLEX.COM](http://WWW.MOLEX.COM) FOR LATEST PART INFORMATION**

**NOTES:**

1. MATERIALS: HOUSING--LIQUID CRYSTAL POLYMER (LCP), GLASS FILLED, UL94V-0, COLOR: BLACK, TERMINAL: PHOSPHOR BRONZE.
2. FINISH: 0.75 MICROMETERS MINIMUM SELECTIVE GOLD (Au) IN MATING AREA; 2.50 MICROMETERS MINIMUM SELECTIVE TIN (Sn) IN TAIL AREA; NICKEL (Ni) UNDERPLATE OVERALL.
3. THIS PART CONFORMS TO MOLEX PRODUCT SPECIFICATION PS-73670-9999.
4. FOR MIXED CONTACT MATING LENGTHS, CONSULT FACTORY FOR AVAILABILITY.
5. PACKAGE PER PK-70873-0818.
6. PARTS MARKED WITH PART NUMBER AND DATE CODE, ON EITHER SIDE, APPROXIMATELY WHERE SHOWN.

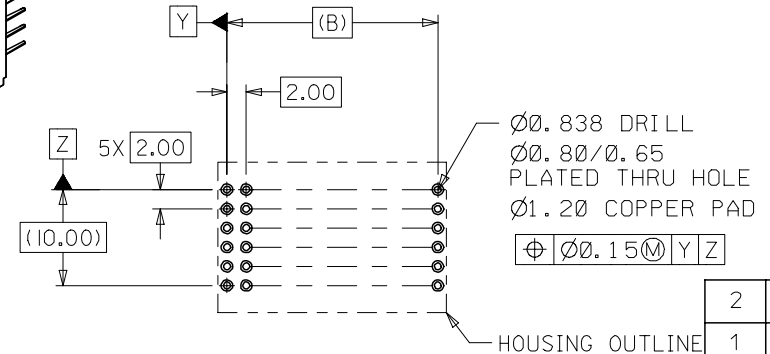
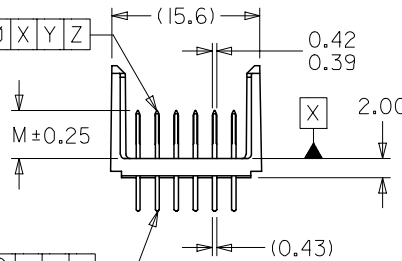
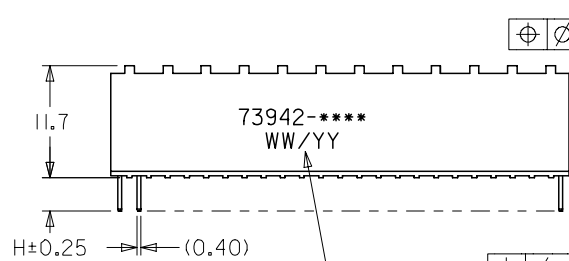
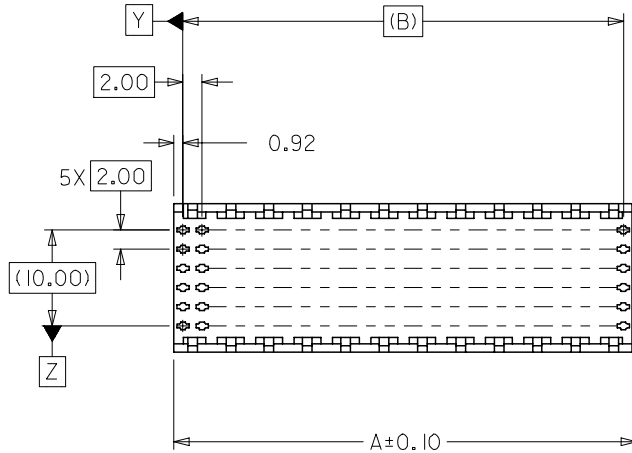
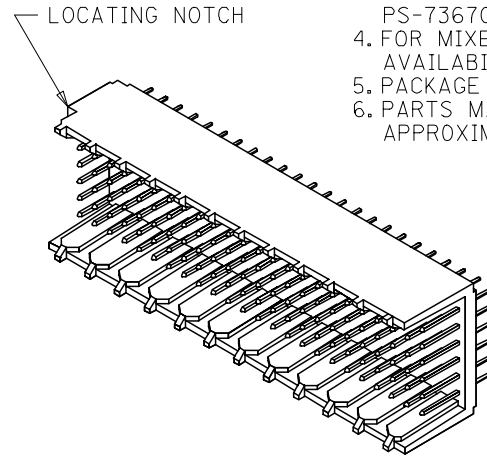

PCB LAYOUT: COMPONENT SIDE  
RECOMMENDED PCB THICKNESS: 2.50 MIN.

|     |     |
|-----|-----|
| 2   | A   |
| 1   | G   |
| SHT | REV |

SEE NOTE 6

|                          |                 |
|--------------------------|-----------------|
| MODIFY FINISH NOTE       | QUALITY SYMBOLS |
| EC NO: UCP2007-2259      | ▽=0             |
| IDRW:MSIBARRA 2007/03/13 | ▽=0             |
| CHKD:BBARKER 2007/03/21  |                 |
| APPR:SMILLER 2007/03/22  |                 |
| DESCRIPTION              |                 |
| REV                      |                 |

|                                       |
|---------------------------------------|
| GENERAL TOLERANCES (UNLESS SPECIFIED) |
| 4 PLACES ± --- ± ---                  |
| 3 PLACES ± --- ± ---                  |
| 2 PLACES ± 0.05 ± ---                 |
| 1 PLACE ± 0.10 ± ---                  |
| ANGULAR ±1/2°                         |

|  |            |                          |                        |
|--|------------|--------------------------|------------------------|
| DIMENSION STYLE                                      | SCALE      | DESIGN UNITS             | THIRD ANGLE PROJECTION |
| MM ONLY  | 2:1        | METRIC                   | ☉                      |
| DRAWN BY   | DATE       | TITLE                    |                        |
| JB INGHAM  | 1998/01/13 | SALES ASSY HDM BACKPLANE |                        |
| CHECKED BY   | DATE       | OPEN END OPTION          |                        |
| SREED  | 1998/01/13 | SOLDER TAIL VERSION      |                        |
| APPROVED BY  | DATE       | MATERIAL NO.             | DOCUMENT NO.           |
| CBIXLER  | 1998/01/13 | SEE CHART                | SD-73942-001           |
| DRAFT WHERE APPLICABLE MUST REMAIN WITHIN DIMENSIONS |            |                          |                        |

|      |   |
|------|---|
| SIZE | THIS DRAWING CONTAINS INFORMATION THAT IS PROPRIETARY TO MOLEX INCORPORATED AND SHOULD NOT BE USED WITHOUT WRITTEN PERMISSION |
| B    |   |



|              |              |           |
|--------------|--------------|-----------|
| MATERIAL NO. | DOCUMENT NO. | SHEET NO. |
| SEE CHART    | SD-73942-001 | 1 OF 2    |

## MATERIAL NUMBER ASSIGNMENT

73942-\* \* 0 0

| NUMBER | CIRCUIT SIZE | DIM "A" | DIM "B" | DIM "H" |
|--------|--------------|---------|---------|---------|
| 0      | 72           | 23.84   | 22.00   | 2.0     |
| 1      | 144          | 47.84   | 46.00   | 2.0     |
| 2      | 72           | 23.84   | 22.00   | 2.5     |
| 3      | 144          | 47.84   | 46.00   | 2.5     |
| 4      | 72           | 23.84   | 22.00   | 3.0     |
| 5      | 144          | 47.84   | 46.00   | 3.0     |
| 6      | 72           | 23.84   | 22.00   | 3.5     |
| 7      | 144          | 47.84   | 46.00   | 3.5     |

| NUMBER | DIM "M" |
|--------|---------|
| 0      | 5.0     |
| 1      | 5.5     |
| 2      | 6.0     |

|   |   |   |   |   |  |  |  |  |                       |
|---|---|---|---|---|--|--|--|--|-----------------------|
| SEE SHEET 1<br>EC No. U81577<br>DRWN:JBINGHAM 98/0203<br>CHK: SREED 98/0203<br>APPR:CBIXLER 98/0203 | MAJOR<br><br>CRITICAL<br> | QUALITY SYMBOLS   | GENERAL TOLERANCES:<br>(UNLESS SPECIFIED) | SCALE<br>---:--   | DESIGN UNITS<br><input checked="" type="checkbox"/> mm <input type="checkbox"/> INCH | DIMENSIONS:<br><input type="checkbox"/> mm <input type="checkbox"/> INCH <input checked="" type="checkbox"/> mm ONLY | SHT<br>REV   |  |                       |
|   |   | DRAWN BY & DATE<br>JBINGHAM 98/01/13  | CHECKED BY & DATE<br>SREED 98/01/13       |   | APPROVED BY & DATE<br>CBIXLER 98/01/13   |  | TITLE: SALES ASSY, HDM BACKPLANE<br>OPEN END OPTION<br>SOLDER TAIL VERSION |  | REVISE ON<br>CAD ONLY |
|   |   | ANGLAR: ± °   |   | DRAFT WHERE APPLICABLE MUST<br>REMAIN WITHIN DIMENSIONS |  | CAD FILENAME<br>S73942X2.DGN   |  | MATERIAL NO. SEE CHART<br>DRAWING NO. SD-73942-001 |                       |
|   |   | THIS DRAWING CONTAINS INFORMATION THAT IS PROPRIETARY TO MOLEX<br>INCORPORATED AND SHOULD NOT BE USED WITHOUT WRITTEN PERMISSION. |   | SHEET NO.<br>2  |  | SIZE<br>B  |  |  |                       |