

General Description

The AOT29S50 & AOB29S50 & AOTF29S50 have been fabricated using the advanced α MOS™ high voltage process that is designed to deliver high levels of performance and robustness in switching applications. By providing low $R_{DS(ON)}$, Q_g and E_{OSS} along with guaranteed avalanche capability these parts can be adopted quickly into new and existing offline power supply designs.

Features

V_{DS} @ $T_{j,max}$	600V
I_{DM}	120A
$R_{DS(ON),max}$	0.15 Ω
$Q_{g,typ}$	26.6nC
E_{OSS} @ 400V	6.3 μ J

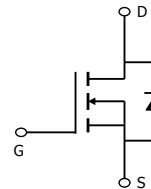

Absolute Maximum Ratings $T_A=25^\circ\text{C}$ unless otherwise noted

Parameter	Symbol	AOT29S50/AOB29S50	AOTF29S50	AOTF29S50L	Units
Drain-Source Voltage	V_{DS}	500			V
Gate-Source Voltage	V_{GS}	± 30			V
Continuous Drain Current	I_D	$T_C=25^\circ\text{C}$	29	29*	29*
		$T_C=100^\circ\text{C}$	18	18*	18*
Pulsed Drain Current ^C	I_{DM}	120			A
Avalanche Current ^C	I_{AR}	7.5			A
Repetitive avalanche energy ^C	E_{AR}	110			mJ
Single pulsed avalanche energy ^G	E_{AS}	608			mJ
Power Dissipation ^B	P_D	$T_C=25^\circ\text{C}$	357	50	37.9
		Derate above 25°C	2.9	0.4	0.3
MOSFET dv/dt ruggedness		100			V/ns
Peak diode recovery dv/dt ^H		20			V/ns
Junction and Storage Temperature Range	T_J, T_{STG}	-55 to 150			$^\circ\text{C}$
Maximum lead temperature for soldering purpose, 1/8" from case for 5 seconds ^J	T_L	300			$^\circ\text{C}$

Thermal Characteristics

Parameter	Symbol	AOT29S50/AOB29S50	AOTF29S50	AOTF29S50L	Units
Maximum Junction-to-Ambient ^{A,D}	$R_{\theta JA}$	65	65	65	$^\circ\text{C}/\text{W}$
Maximum Case-to-sink ^A	$R_{\theta CS}$	0.5	--	--	$^\circ\text{C}/\text{W}$
Maximum Junction-to-Case	$R_{\theta JC}$	0.35	2.5	3.3	$^\circ\text{C}/\text{W}$

* Drain current limited by maximum junction temperature.

Electrical Characteristics (T_J=25°C unless otherwise noted)

Symbol	Parameter	Conditions	Min	Typ	Max	Units
STATIC PARAMETERS						
BV _{DSS}	Drain-Source Breakdown Voltage	I _D =250μA, V _{GS} =0V, T _J =25°C	500	-	-	V
		I _D =250μA, V _{GS} =0V, T _J =150°C	550	600	-	
I _{DSS}	Zero Gate Voltage Drain Current	V _{DS} =500V, V _{GS} =0V	-	-	1	μA
		V _{DS} =400V, T _J =150°C	-	10	-	
I _{GSS}	Gate-Body leakage current	V _{DS} =0V, V _{GS} =±30V	-	-	±100	nA
V _{GS(th)}	Gate Threshold Voltage	V _{DS} =5V, I _D =250μA	2.6	3.3	3.9	V
R _{DS(ON)}	Static Drain-Source On-Resistance	V _{GS} =10V, I _D =14.5A, T _J =25°C	-	0.13	0.15	Ω
		V _{GS} =10V, I _D =14.5A, T _J =150°C	-	0.34	0.4	Ω
V _{SD}	Diode Forward Voltage	I _S =14.5A, V _{GS} =0V, T _J =25°C	-	0.85	-	V
I _S	Maximum Body-Diode Continuous Current		-	-	29	A
I _{SM}	Maximum Body-Diode Pulsed Current		-	-	120	A
DYNAMIC PARAMETERS						
C _{iss}	Input Capacitance	V _{GS} =0V, V _{DS} =100V, f=1MHz	-	1312	-	pF
C _{oss}	Output Capacitance		-	88	-	pF
C _{o(er)}	Effective output capacitance, energy related ^H	V _{GS} =0V, V _{DS} =0 to 400V, f=1MHz	-	78	-	pF
C _{o(tr)}	Effective output capacitance, time related ^I		-	227	-	pF
C _{rss}	Reverse Transfer Capacitance	V _{GS} =0V, V _{DS} =100V, f=1MHz	-	2.5	-	pF
R _g	Gate resistance	V _{GS} =0V, V _{DS} =0V, f=1MHz	-	4.8	-	Ω
SWITCHING PARAMETERS						
Q _g	Total Gate Charge	V _{GS} =10V, V _{DS} =400V, I _D =14.5A	-	26.6	-	nC
Q _{gs}	Gate Source Charge		-	6.2	-	nC
Q _{gd}	Gate Drain Charge		-	9.2	-	nC
t _{D(on)}	Turn-On Delay Time	V _{GS} =10V, V _{DS} =400V, I _D =14.5A, R _G =25Ω	-	28	-	ns
t _r	Turn-On Rise Time		-	39	-	ns
t _{D(off)}	Turn-Off Delay Time		-	103	-	ns
t _f	Turn-Off Fall Time		-	40	-	ns
t _{rr}	Body Diode Reverse Recovery Time	I _F =14.5A, di/dt=100A/μs, V _{DS} =400V	-	387	-	ns
I _{rm}	Peak Reverse Recovery Current	I _F =14.5A, di/dt=100A/μs, V _{DS} =400V	-	29.6	-	A
Q _{rr}	Body Diode Reverse Recovery Charge	I _F =14.5A, di/dt=100A/μs, V _{DS} =400V	-	7.3	-	μC

A. The value of R_{θJA} is measured with the device in a still air environment with T_A=25°C.

B. The power dissipation P_D is based on T_{J(MAX)}=150°C, using junction-to-case thermal resistance, and is more useful in setting the upper dissipation limit for cases where additional heatsinking is used.

C. Repetitive rating, pulse width limited by junction temperature T_{J(MAX)}=150°C. Ratings are based on low frequency and duty cycles to keep initial T_J=25°C.

D. The R_{θJA} is the sum of the thermal impedance from junction to case R_{θJC} and case to ambient.

E. The static characteristics in Figures 1 to 6 are obtained using <300 μs pulses, duty cycle 0.5% max.

F. These curves are based on the junction-to-case thermal impedance which is measured with the device mounted to a large heatsink, assuming a maximum junction temperature of T_{J(MAX)}=150°C. The SOA curve provides a single pulse rating.

G. L=60mH, I_{AS}=4.5A, V_{DD}=150V, Starting T_J=25°C

H. C_{o(er)} is a fixed capacitance that gives the same stored energy as C_{oss} while V_{DS} is rising from 0 to 80% V_{(BR)DSS}.

I. C_{o(tr)} is a fixed capacitance that gives the same charging time as C_{oss} while V_{DS} is rising from 0 to 80% V_{(BR)DSS}.

J. Wavesoldering only allowed at leads.

TYPICAL ELECTRICAL AND THERMAL CHARACTERISTICS

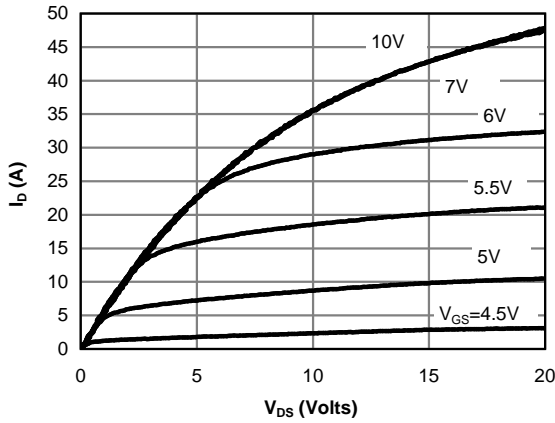

Figure 1: On-Region Characteristics @ 25°C

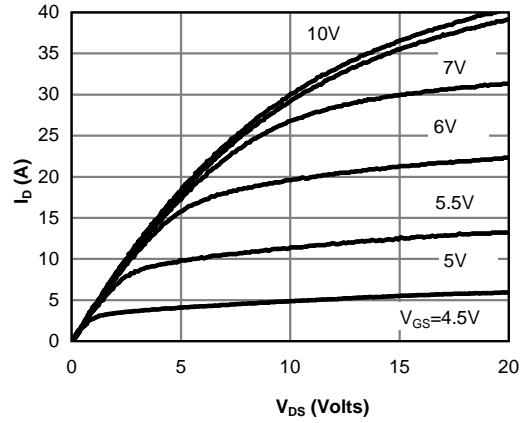

Figure 2: On-Region Characteristics @ 125°C

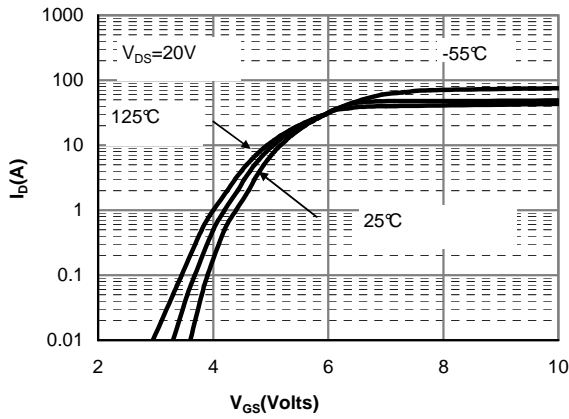

Figure 3: Transfer Characteristics

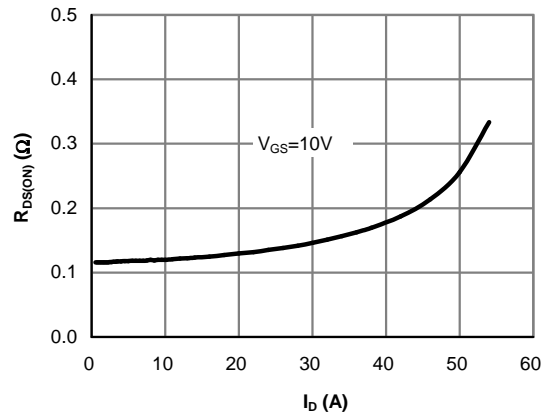

Figure 4: On-Resistance vs. Drain Current and Gate Voltage

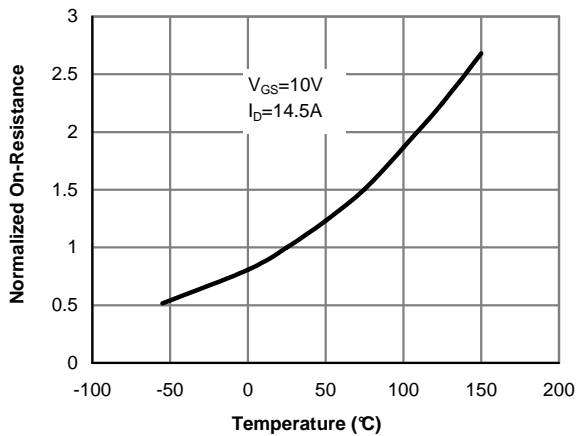

Figure 5: On-Resistance vs. Junction Temperature

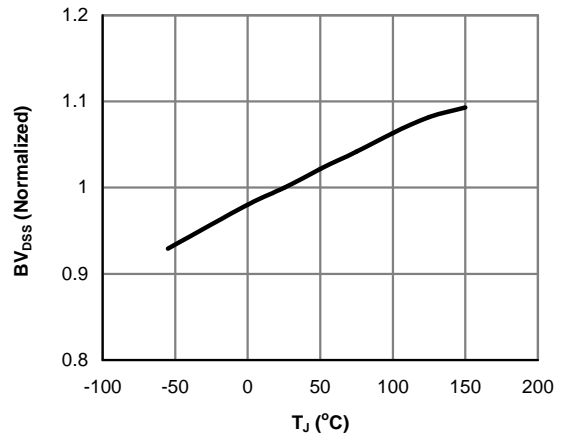

Figure 6: Break Down vs. Junction Temperature

TYPICAL ELECTRICAL AND THERMAL CHARACTERISTICS

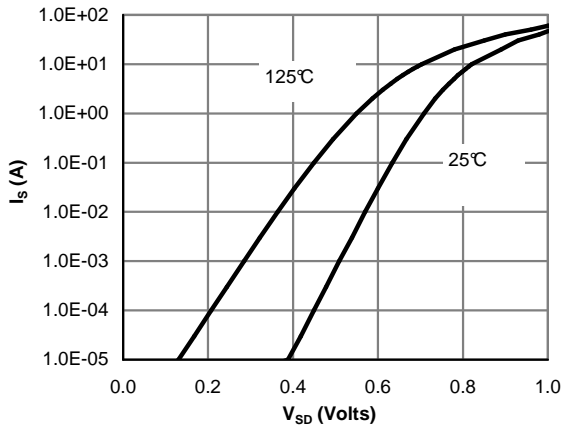

Figure 7: Body-Diode Characteristics (Note E)

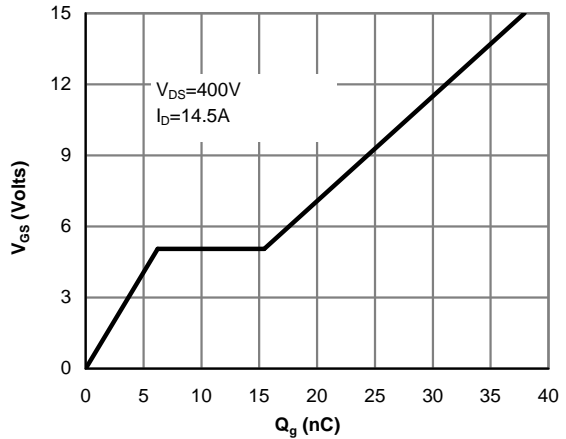

Figure 8: Gate-Charge Characteristics

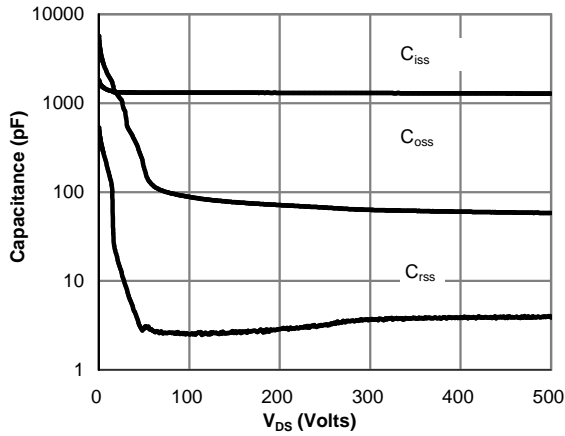

Figure 9: Capacitance Characteristics

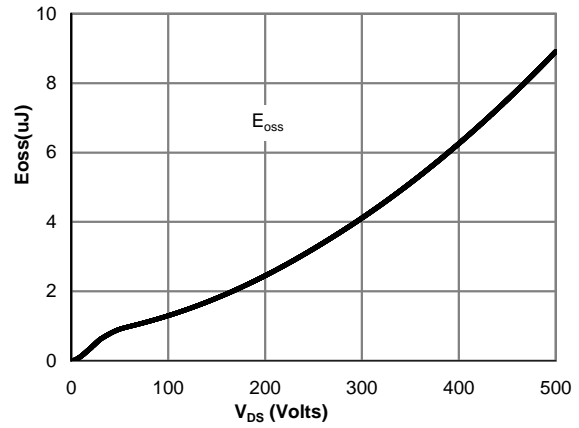

Figure 10: Coss stored Energy

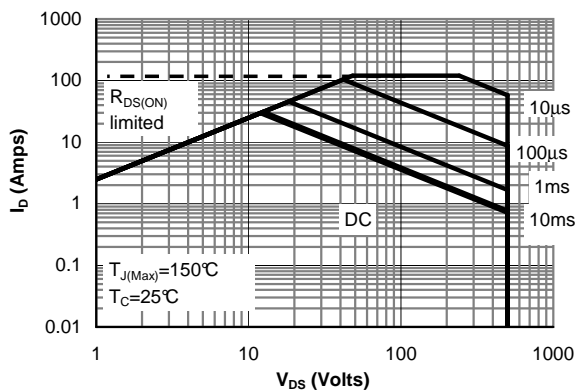

Figure 11: Maximum Forward Biased Safe Operating Area for AOT(B)29S50 (Note F)

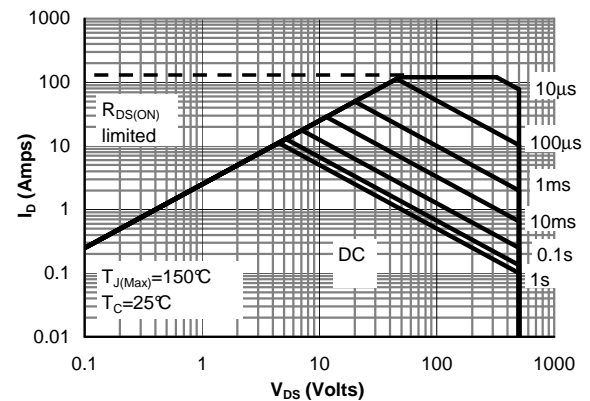

Figure 12: Maximum Forward Biased Safe Operating Area for AOTF29S50 (Note F)

TYPICAL ELECTRICAL AND THERMAL CHARACTERISTICS

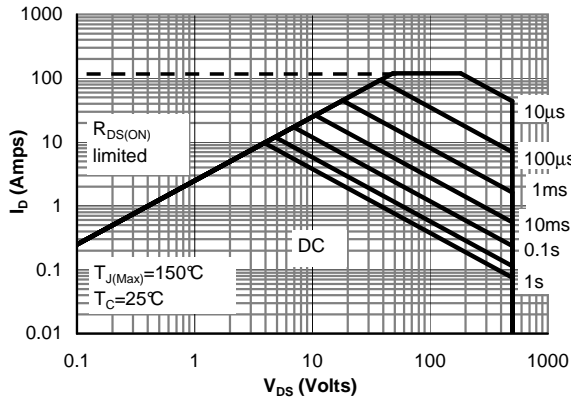

Figure 13: Maximum Forward Biased Safe Operating Area for AOTF29S50L(Note F)

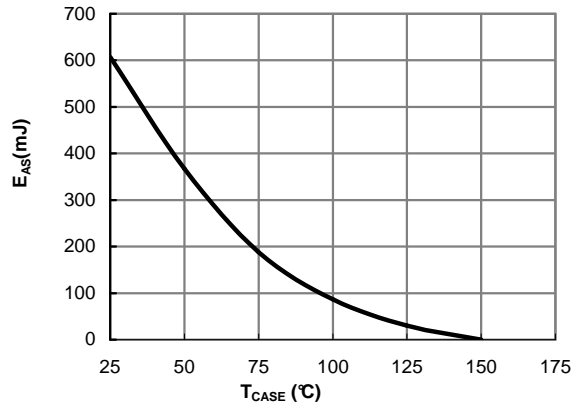

Figure 14: Avalanche energy

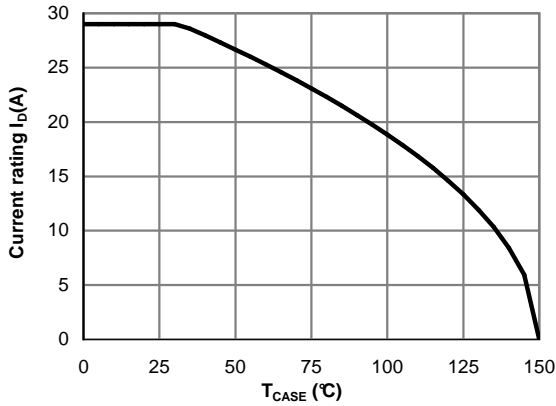

Figure 15: Current De-rating (Note B)

TYPICAL ELECTRICAL AND THERMAL CHARACTERISTICS

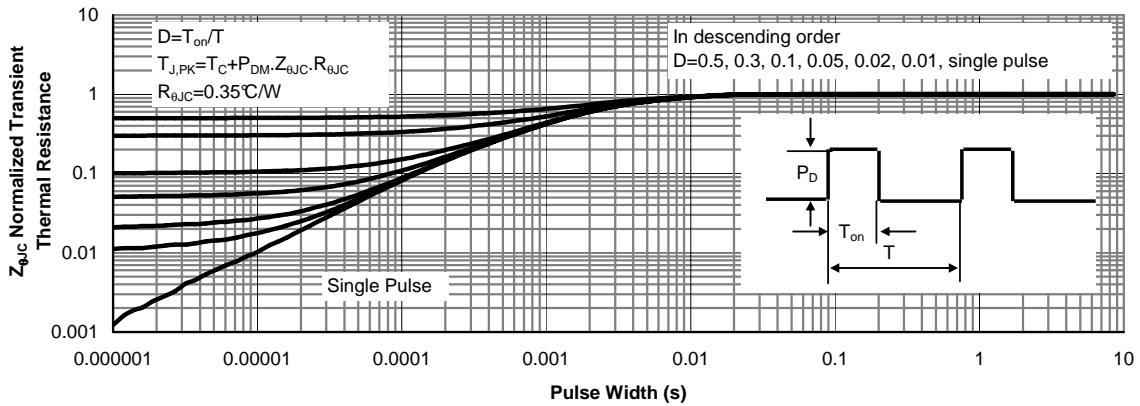

Figure 16: Normalized Maximum Transient Thermal Impedance for AOT(B)29S50 (Note F)

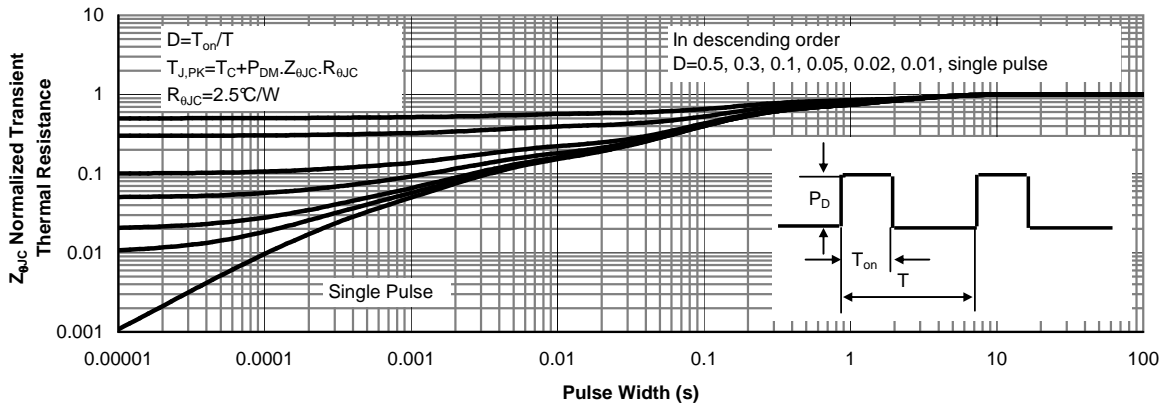

Figure 17: Normalized Maximum Transient Thermal Impedance for AOTF29S50 (Note F)

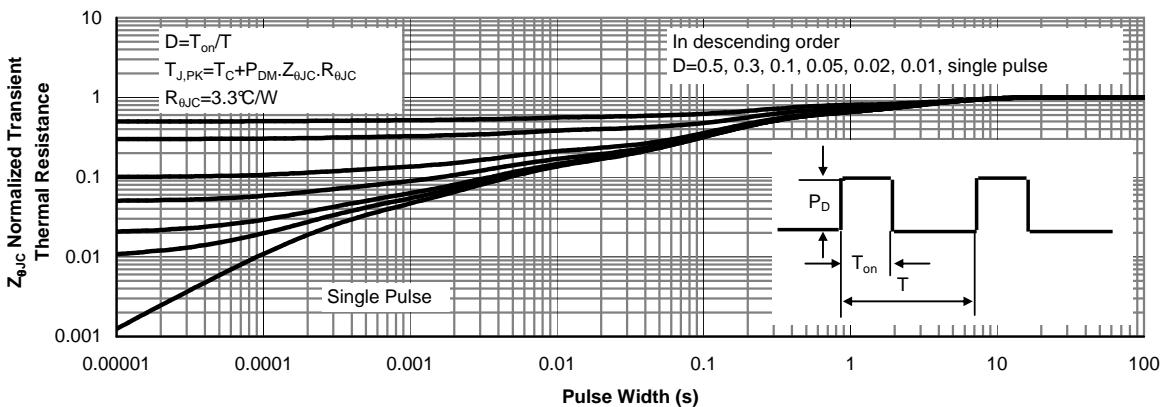
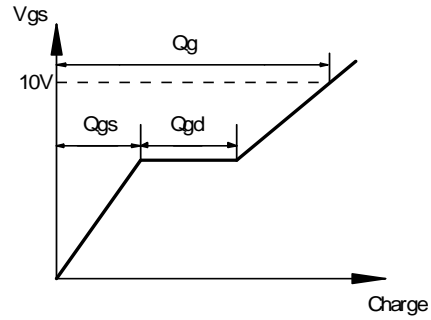
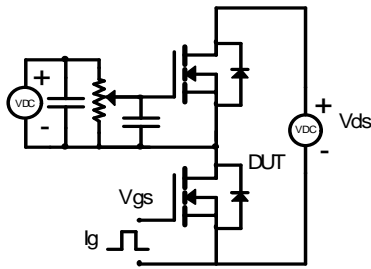
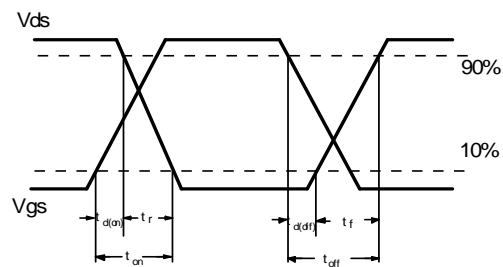
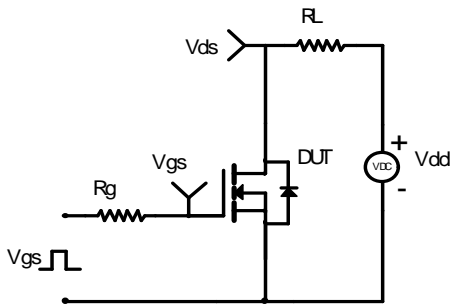

Figure 18: Normalized Maximum Transient Thermal Impedance for AOTF29S50L (Note F)

Gate Charge Test Circuit & Waveform



Resistive Switching Test Circuit & Waveforms



Unclamped Inductive Switching (UIS) Test Circuit & Waveforms

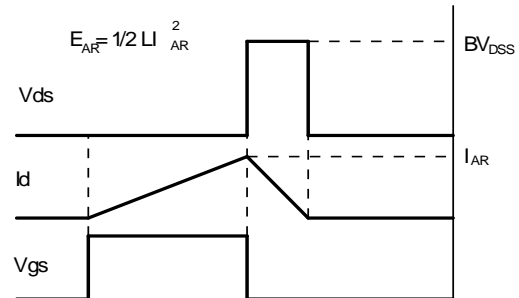
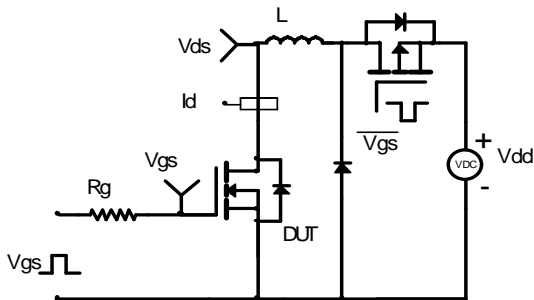

Diode Recovery Test Circuit & Waveforms

