

Cool MOS™ Power Transistor

Feature

- New revolutionary high voltage technology
- Ultra low gate charge
- Periodic avalanche rated
- Extreme dv/dt rated
- High peak current capability
- Improved transconductance
- P-TO-220-3-31: Fully isolated package (2500 VAC; 1 minute)

| | | |
|---------------------|------|----------|
| $V_{DS} @ T_{jmax}$ | 650 | V |
| $R_{DS(on)}$ | 0.95 | Ω |
| I_D | 4.5 | A |

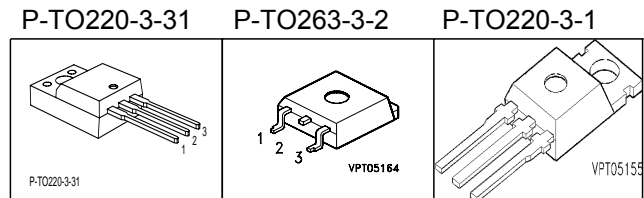

| Type | Package | Ordering Code | Marking |
|------------|--------------|---------------|---------|
| SPP04N60C3 | P-TO220-3-1 | Q67040-S4366 | 04N60C3 |
| SPB04N60C3 | P-TO263-3-2 | Q67040-S4407 | 04N60C3 |
| SPA04N60C3 | P-TO220-3-31 | Q67040-S4413 | 04N60C3 |

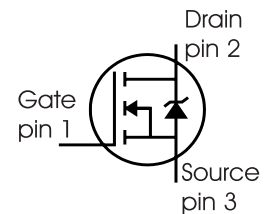

Maximum Ratings

| Parameter | Symbol | Value | | Unit |
|---|--------------------|------------|--|-------------|
| | | SPP_B | SPA | |
| Continuous drain current $T_C = 25\text{ °C}$ $T_C = 100\text{ °C}$ | I_D | 4.5 2.8 | 4.5 ¹⁾ 2.8 ¹⁾ | A |
| Pulsed drain current, t_p limited by T_{jmax} | $I_D \text{ puls}$ | 13.5 | 13.5 | A |
| Avalanche energy, single pulse $I_D=3.4, V_{DD}=50V$ | E_{AS} | 130 | 130 | mJ |
| Avalanche energy, repetitive t_{AR} limited by T_{jmax} ²⁾ $I_D=4.5A, V_{DD}=50V$ | E_{AR} | 0.4 | 0.4 | |
| Avalanche current, repetitive t_{AR} limited by T_{jmax} | I_{AR} | 4.5 | 4.5 | A |
| Gate source voltage static | V_{GS} | ± 20 | ± 20 | V |
| Gate source voltage AC ($f > 1\text{Hz}$) | V_{GS} | ± 30 | ± 30 | |
| Power dissipation, $T_C = 25\text{ °C}$ | P_{tot} | 50 | 31 | W |
| Operating and storage temperature | T_j, T_{stg} | -55...+150 | | °C |

Maximum Ratings

| Parameter | Symbol | Value | Unit |
|--|---------|-------|------|
| Drain Source voltage slope $V_{DS} = 480\text{ V}, I_D = 4.5\text{ A}, T_j = 125\text{ }^\circ\text{C}$ | dv/dt | 50 | V/ns |

Thermal Characteristics

| Parameter | Symbol | Values | | | Unit |
|---|----------------------|--------|------|------|------|
| | | min. | typ. | max. | |
| Thermal resistance, junction - case | R_{thJC} | - | - | 2.5 | K/W |
| Thermal resistance, junction - case, FullPAK | $R_{thJC\text{ FP}}$ | - | - | 4 | |
| Thermal resistance, junction - ambient, leaded | R_{thJA} | - | - | 62 | |
| Thermal resistance, junction - ambient, FullPAK | $R_{thJA\text{ FP}}$ | - | - | 80 | |
| SMD version, device on PCB: @ min. footprint @ 6 cm ² cooling area ³⁾ | R_{thJA} | - | - | 62 | |
| | | - | 35 | - | |
| Soldering temperature, 1.6 mm (0.063 in.) from case for 10s ⁴⁾ | T_{sold} | - | - | 260 | °C |

Electrical Characteristics, at $T_j=25^\circ\text{C}$ unless otherwise specified

| Parameter | Symbol | Conditions | Values | | | Unit |
|--|---------------|--|--------|------|------|---------------|
| | | | min. | typ. | max. | |
| Drain-source breakdown voltage | $V_{(BR)DSS}$ | $V_{GS}=0\text{V}, I_D=0.25\text{mA}$ | 600 | - | - | V |
| Drain-Source avalanche breakdown voltage | $V_{(BR)DS}$ | $V_{GS}=0\text{V}, I_D=4.5\text{A}$ | - | 700 | - | |
| Gate threshold voltage | $V_{GS(th)}$ | $I_D=200\mu\text{A}, V_{GS}=V_{DS}$ | 2.1 | 3 | 3.9 | |
| Zero gate voltage drain current | I_{DSS} | $V_{DS}=600\text{V}, V_{GS}=0\text{V},$ $T_j=25^\circ\text{C}$ $T_j=150^\circ\text{C}$ | - | 0.5 | 1 | μA |
| | | | - | - | 50 | |
| Gate-source leakage current | I_{GSS} | $V_{GS}=30\text{V}, V_{DS}=0\text{V}$ | - | - | 100 | nA |
| Drain-source on-state resistance | $R_{DS(on)}$ | $V_{GS}=10\text{V}, I_D=2.8\text{A}$ $T_j=25^\circ\text{C}$ $T_j=150^\circ\text{C}$ | - | 0.85 | 0.95 | Ω |
| | | | - | 2.3 | - | |
| Gate input resistance | R_G | $f=1\text{MHz}, \text{open drain}$ | - | 0.95 | - | |

Electrical Characteristics

| Parameter | Symbol | Conditions | Values | | | Unit |
|---|--------------|--|--------|------|------|------|
| | | | min. | typ. | max. | |
| Transconductance | g_{fs} | $V_{DS} \geq 2 \cdot I_D \cdot R_{DS(on)max}$, $I_D = 2.8A$ | - | 4.4 | - | S |
| Input capacitance | C_{iss} | $V_{GS} = 0V$, $V_{DS} = 25V$, $f = 1MHz$ | - | 490 | - | pF |
| Output capacitance | C_{oss} | | - | 160 | - | |
| Reverse transfer capacitance | C_{rss} | | - | 15 | - | |
| Effective output capacitance, ⁵⁾ energy related | $C_{o(er)}$ | $V_{GS} = 0V$, $V_{DS} = 0V$ to 480V | - | 20 | - | |
| Effective output capacitance, ⁶⁾ time related | $C_{o(tr)}$ | | - | 35 | - | |
| Turn-on delay time | $t_{d(on)}$ | $V_{DD} = 380V$, $V_{GS} = 0/10V$, $I_D = 4.5A$, $R_G = 18\Omega$ | - | 6 | - | ns |
| Rise time | t_r | | - | 2.5 | - | |
| Turn-off delay time | $t_{d(off)}$ | | - | 58.5 | 80 | |
| Fall time | t_f | | - | 9.5 | 14 | |

Gate Charge Characteristics

| | | | | | | |
|-----------------------|-----------------|---|---|-----|----|----|
| Gate to source charge | Q_{gs} | $V_{DD} = 480V$, $I_D = 4.5A$ | - | 2.2 | - | nC |
| Gate to drain charge | Q_{gd} | | - | 8.8 | - | |
| Gate charge total | Q_g | $V_{DD} = 480V$, $I_D = 4.5A$, $V_{GS} = 0$ to 10V | - | 19 | 25 | |
| Gate plateau voltage | $V_{(plateau)}$ | $V_{DD} = 480V$, $I_D = 4.5A$ | - | 5 | - | V |

¹Limited only by maximum temperature

²Repetitive avalanche causes additional power losses that can be calculated as $P_{AV} = E_{AR} \cdot f$.

³Device on 40mm*40mm*1.5mm epoxy PCB FR4 with 6cm² (one layer, 70 μm thick) copper area for drain connection. PCB is vertical without blown air.

⁴Soldering temperature for TO-263: 220°C, reflow

⁵ $C_{o(er)}$ is a fixed capacitance that gives the same stored energy as C_{oss} while V_{DS} is rising from 0 to 80% V_{DSS} .

⁶ $C_{o(tr)}$ is a fixed capacitance that gives the same charging time as C_{oss} while V_{DS} is rising from 0 to 80% V_{DSS} .

Electrical Characteristics

| Parameter | Symbol | Conditions | Values | | | Unit |
|---|--------------|-----------------------------------|--------|------|------|------------------------|
| | | | min. | typ. | max. | |
| Inverse diode continuous forward current | I_S | $T_C=25^\circ\text{C}$ | - | - | 4.5 | A |
| Inverse diode direct current, pulsed | I_{SM} | | - | - | 13.5 | |
| Inverse diode forward voltage | V_{SD} | $V_{GS}=0\text{V}, I_F=I_S$ | - | 1 | 1.2 | V |
| Reverse recovery time | t_{rr} | $V_R=480\text{V}, I_F=I_S,$ | - | 300 | 500 | ns |
| Reverse recovery charge | Q_{rr} | $di_F/dt=100\text{A}/\mu\text{s}$ | - | 2.6 | - | μC |
| Peak reverse recovery current | I_{rrm} | | - | 18 | - | A |
| Peak rate of fall of reverse recovery current | di_{rr}/dt | $T_j=25^\circ\text{C}$ | - | 900 | - | $\text{A}/\mu\text{s}$ |

Typical Transient Thermal Characteristics

| Symbol | Value | | Unit | Symbol | Value | | Unit |
|-----------|-------|-------|------|-----------|------------|------------|------|
| | SPP_B | SPA | | | SPP_B | SPA | |
| R_{th1} | 0.039 | 0.039 | K/W | C_{th1} | 0.00007347 | 0.00007347 | Ws/K |
| R_{th2} | 0.074 | 0.074 | | C_{th2} | 0.0002831 | 0.0002831 | |
| R_{th3} | 0.132 | 0.132 | | C_{th3} | 0.0004062 | 0.0004062 | |
| R_{th4} | 0.555 | 0.272 | | C_{th4} | 0.001215 | 0.001215 | |
| R_{th5} | 0.529 | 0.559 | | C_{th5} | 0.00276 | 0.005633 | |
| R_{th6} | 0.169 | 2.523 | | C_{th6} | 0.029 | 0.412 | |

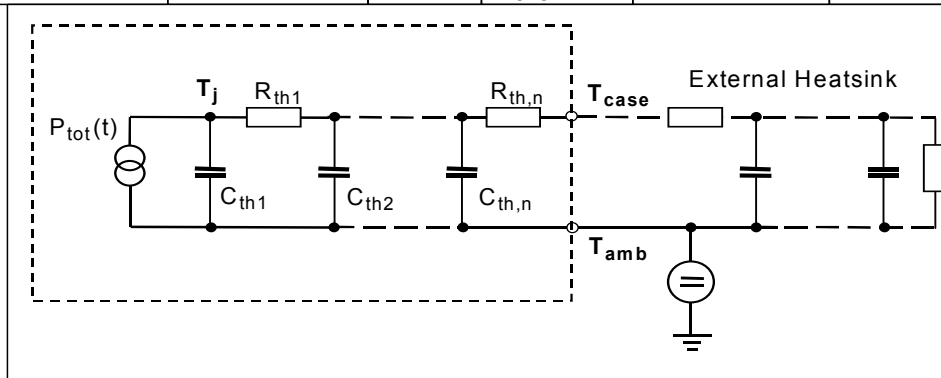

1 Power dissipation

$P_{tot} = f(T_C)$

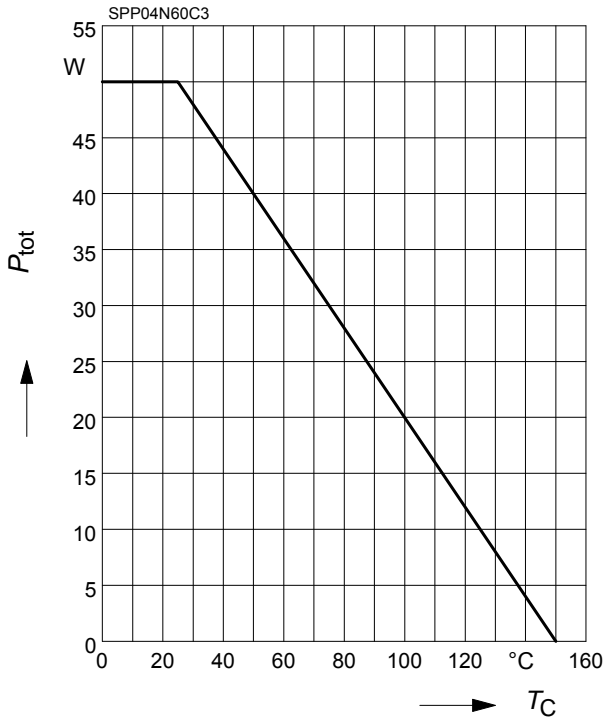

2 Power dissipation FullPAK

$P_{tot} = f(T_C)$

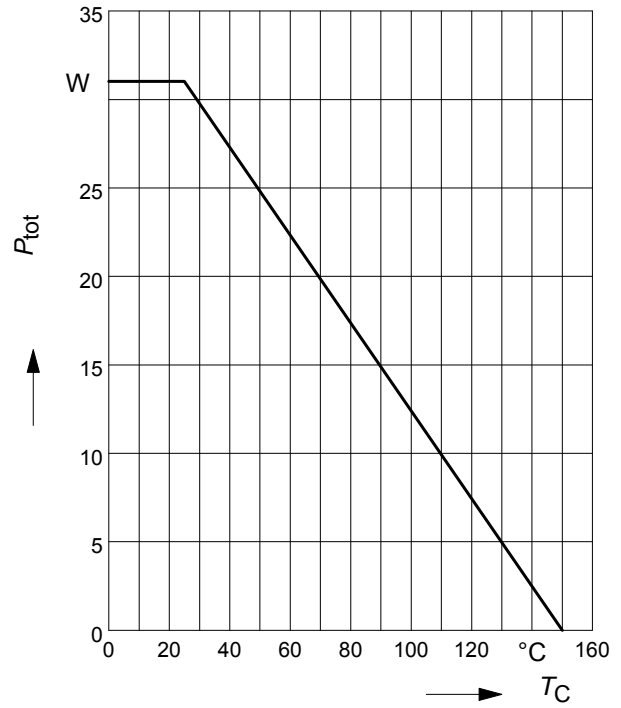

3 Safe operating area

$I_D = f(V_{DS})$

parameter : $D = 0$, $T_C = 25^\circ\text{C}$

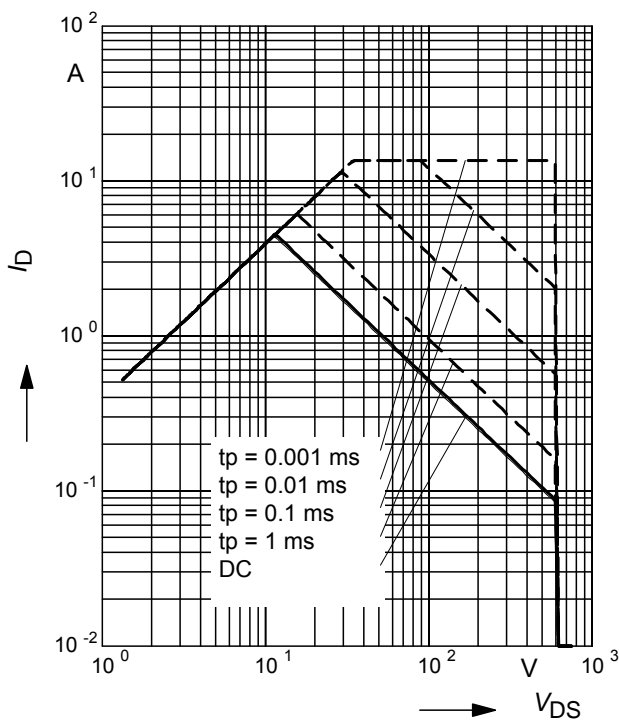

4 Safe operating area FullPAK

$I_D = f(V_{DS})$

parameter: $D = 0$, $T_C = 25^\circ\text{C}$

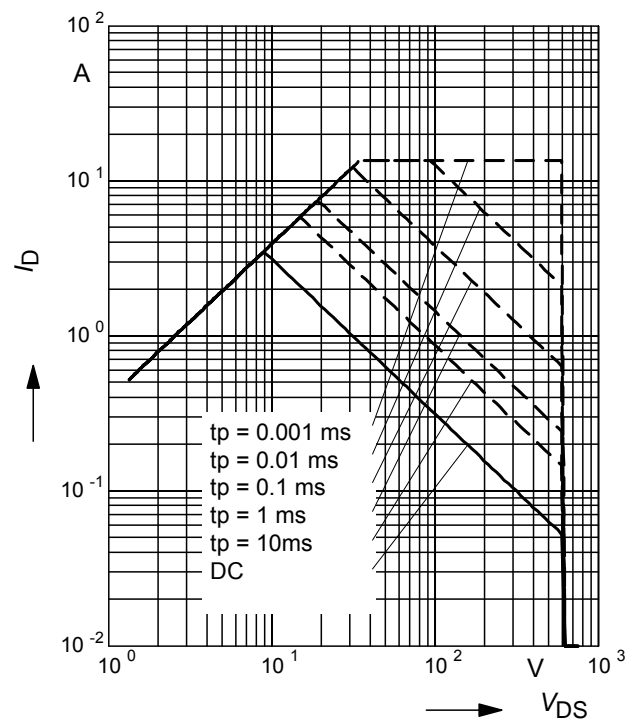

5 Transient thermal impedance

$Z_{thJC} = f(t_p)$

parameter: $D = t_p/T$

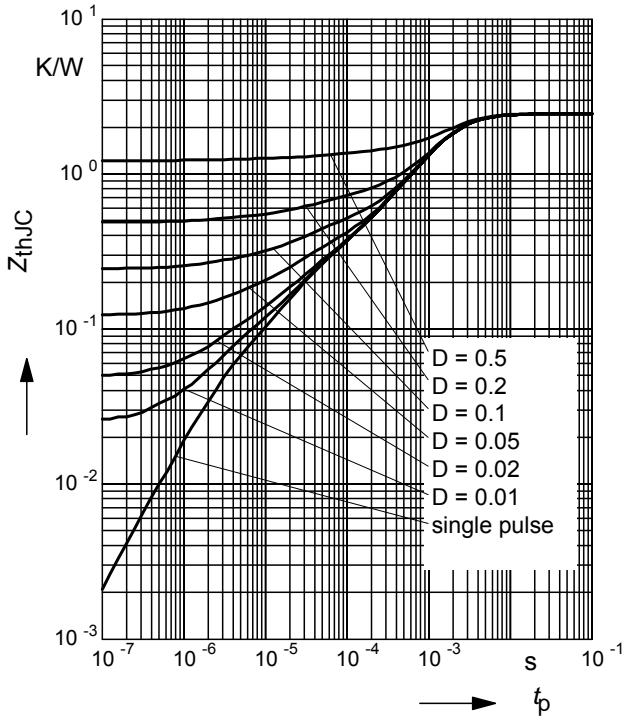

6 Transient thermal impedance FullPAK

$Z_{thJC} = f(t_p)$

parameter: $D = t_p/t$

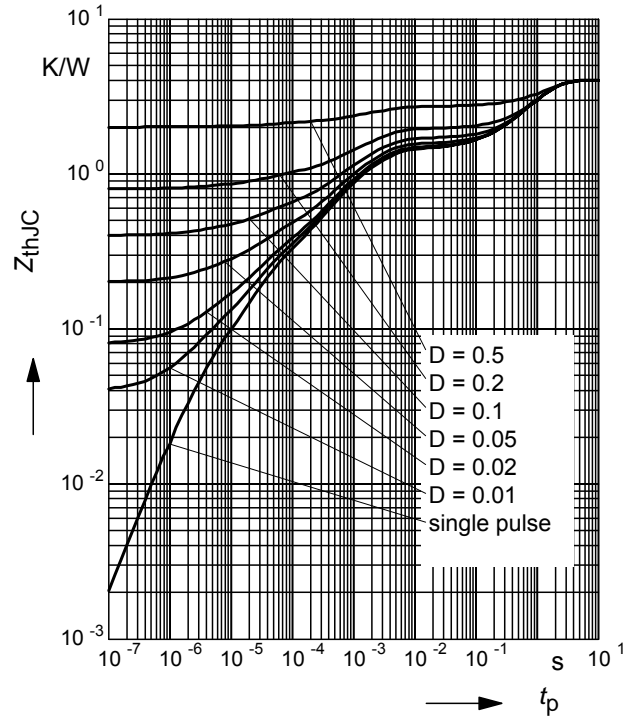

7 Typ. output characteristic

$I_D = f(V_{DS}); T_j = 25^\circ C$

parameter: $t_p = 10 \mu s, V_{GS}$

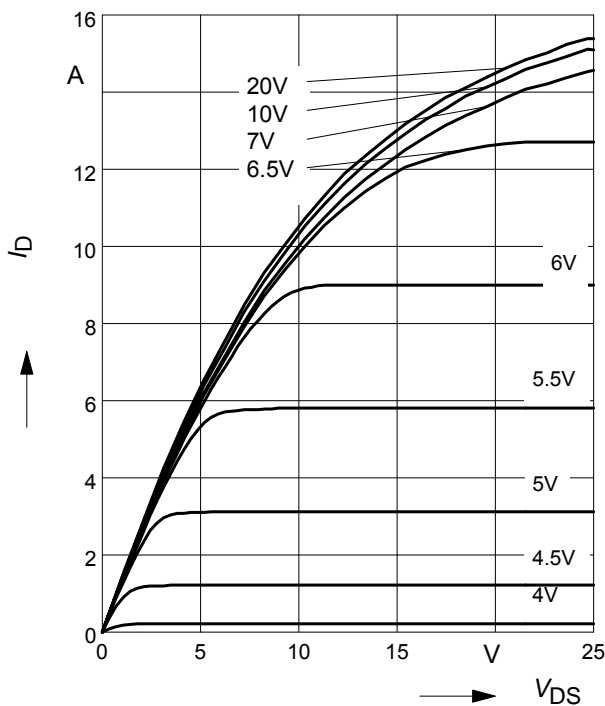

8 Typ. output characteristic

$I_D = f(V_{DS}); T_j = 150^\circ C$

parameter: $t_p = 10 \mu s, V_{GS}$

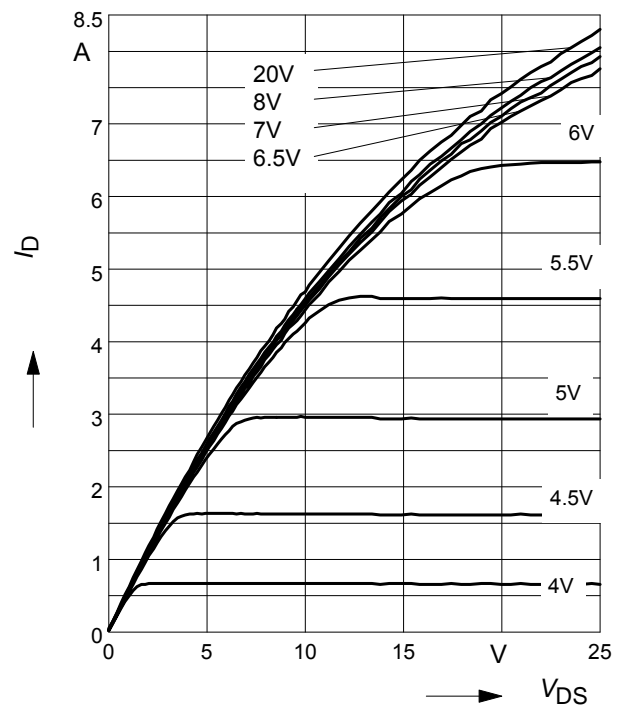

9 Typ. drain-source on resistance

$$R_{DS(on)} = f(I_D)$$

parameter: $T_j = 150^\circ\text{C}$, V_{GS}

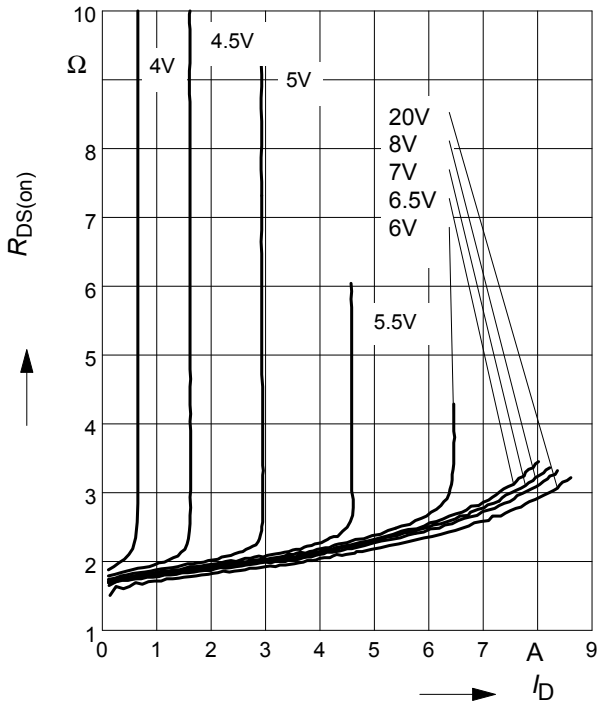

10 Drain-source on-state resistance

$$R_{DS(on)} = f(T_j)$$

parameter: $I_D = 2.8\text{ A}$, $V_{GS} = 10\text{ V}$

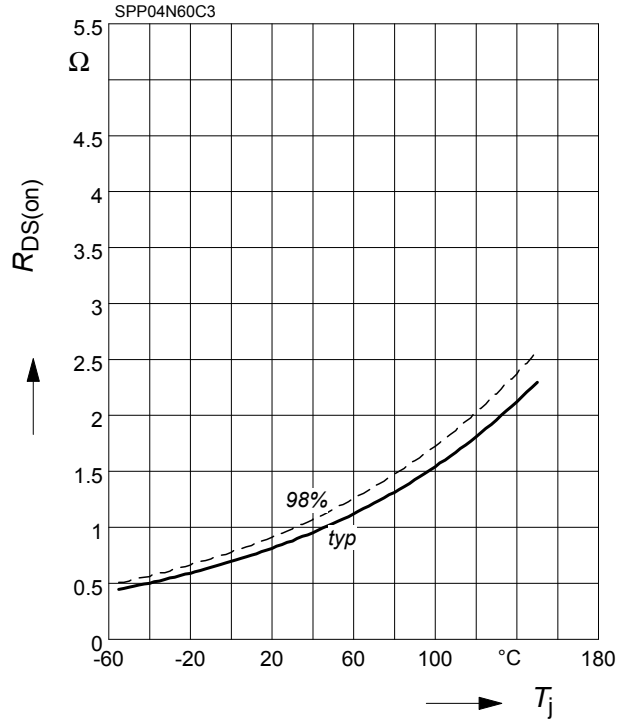

11 Typ. transfer characteristics

$$I_D = f(V_{GS}); V_{DS} \geq 2 \times I_D \times R_{DS(on)max}$$

parameter: $t_p = 10\ \mu\text{s}$

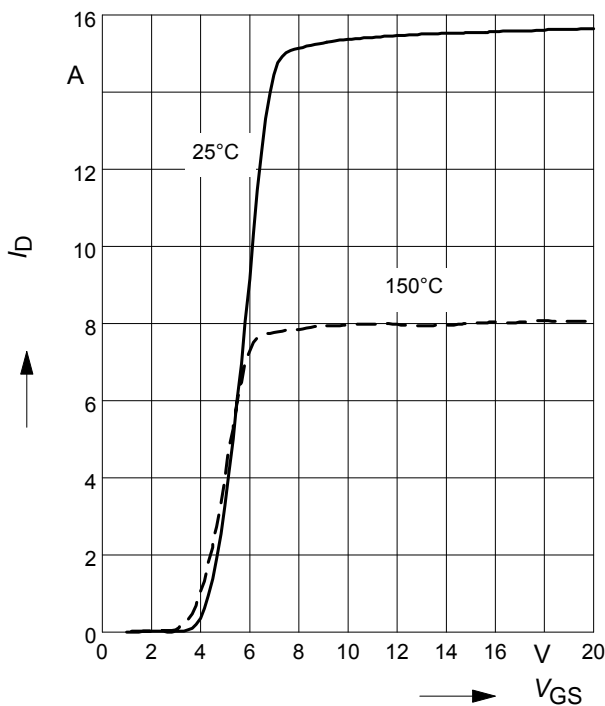

12 Typ. gate charge

$$V_{GS} = f(Q_{Gate})$$

parameter: $I_D = 4.5\text{ A pulsed}$

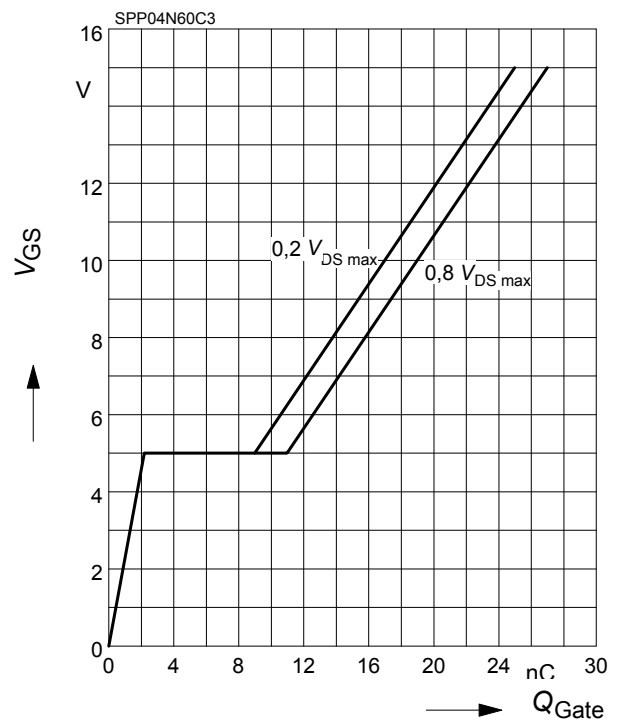

13 Forward characteristics of body diode

$I_F = f(V_{SD})$

parameter: T_j , $t_p = 10 \mu s$

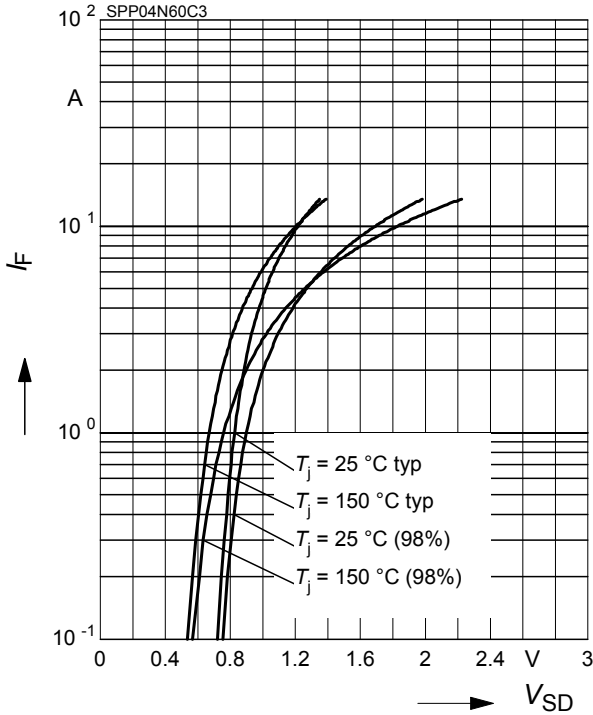

14 Typ. switching time

$t = f(I_D)$, inductive load, $T_j = 125^\circ C$

par.: $V_{DS} = 380V$, $V_{GS} = 0/+13V$, $R_G = 18\Omega$

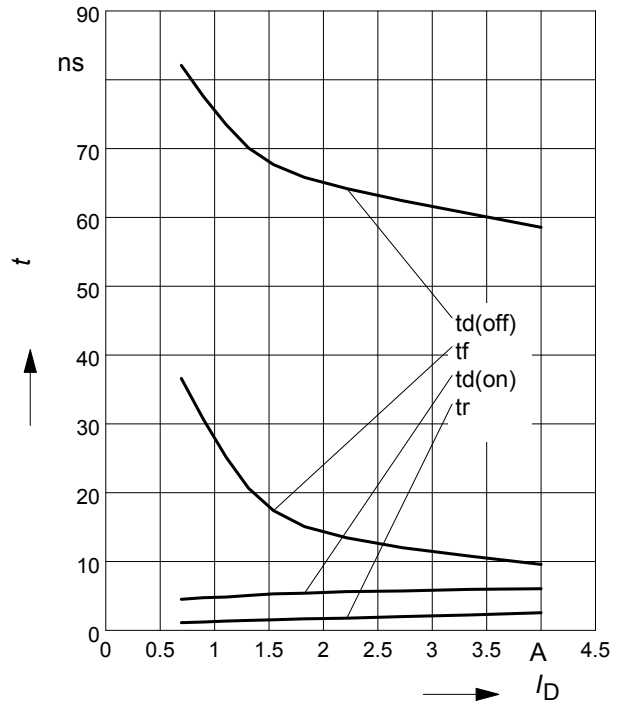

15 Typ. switching time

$t = f(R_G)$, inductive load, $T_j = 125^\circ C$

par.: $V_{DS} = 380V$, $V_{GS} = 0/+13V$, $I_D = 4.5 A$

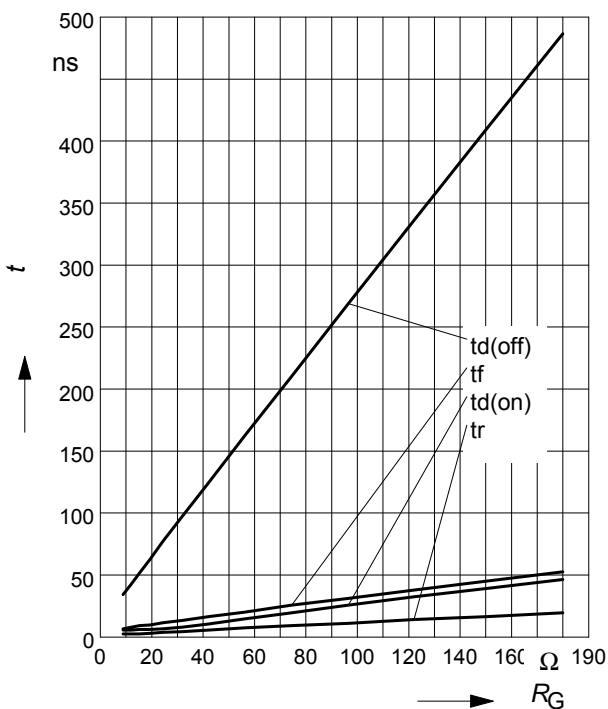

16 Typ. drain current slope

$di/dt = f(R_G)$, inductive load, $T_j = 125^\circ C$

par.: $V_{DS} = 380V$, $V_{GS} = 0/+13V$, $I_D = 4.5A$

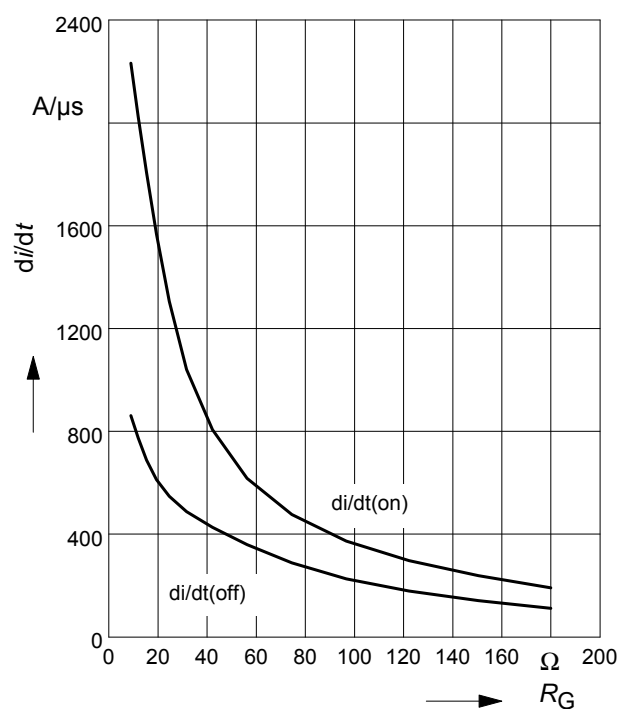

17 Typ. drain source voltage slope

$dv/dt = f(R_G)$, inductive load, $T_j = 125^\circ\text{C}$
par.: $V_{DS}=380\text{V}$, $V_{GS}=0/+13\text{V}$, $I_D=4.5\text{A}$

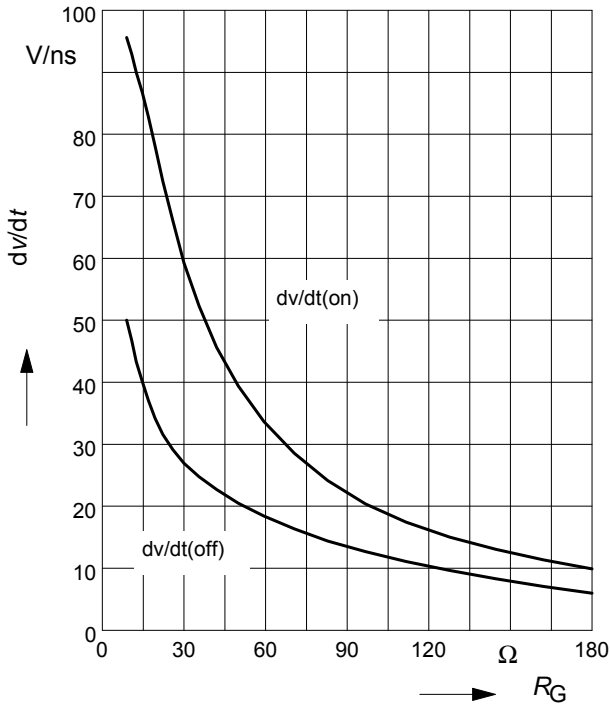

18 Typ. switching losses

$E = f(I_D)$, inductive load, $T_j=125^\circ\text{C}$
par.: $V_{DS}=380\text{V}$, $V_{GS}=0/+13\text{V}$, $R_G=18\Omega$

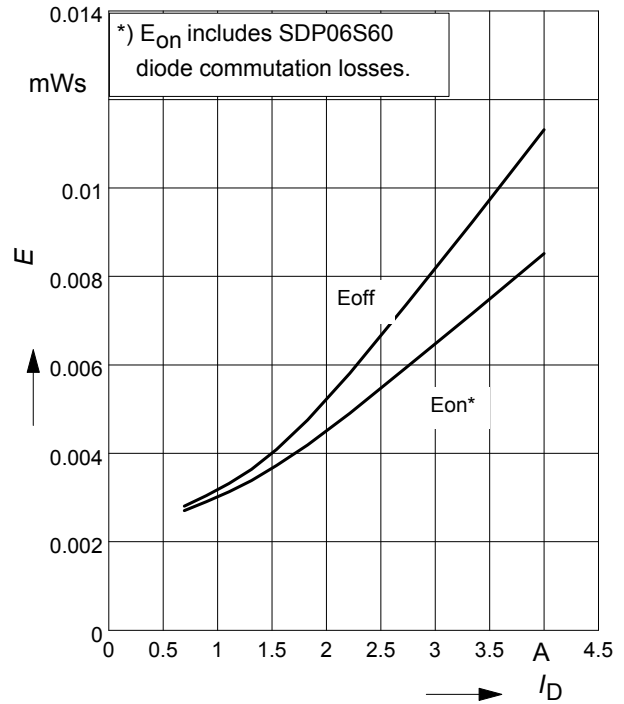

19 Typ. switching losses

$E = f(R_G)$, inductive load, $T_j=125^\circ\text{C}$
par.: $V_{DS}=380\text{V}$, $V_{GS}=0/+13\text{V}$, $I_D=4.5\text{A}$

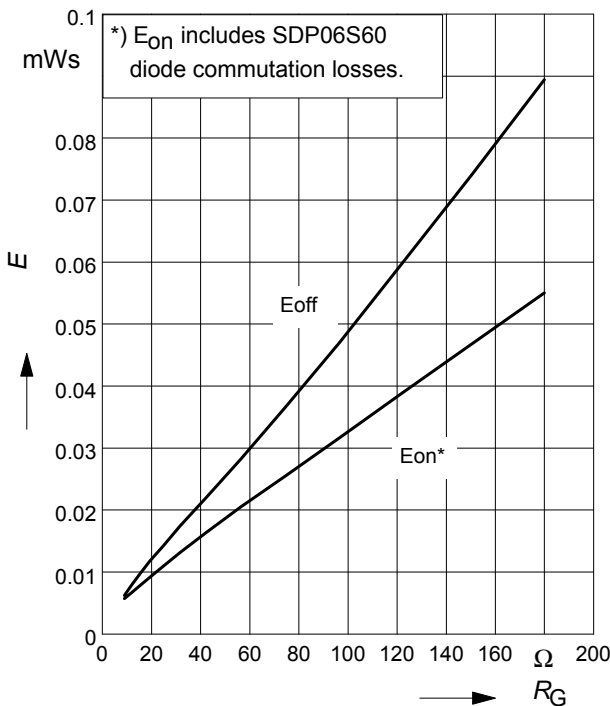

20 Avalanche SOA

$I_{AR} = f(t_{AR})$
par.: $T_j \leq 150^\circ\text{C}$

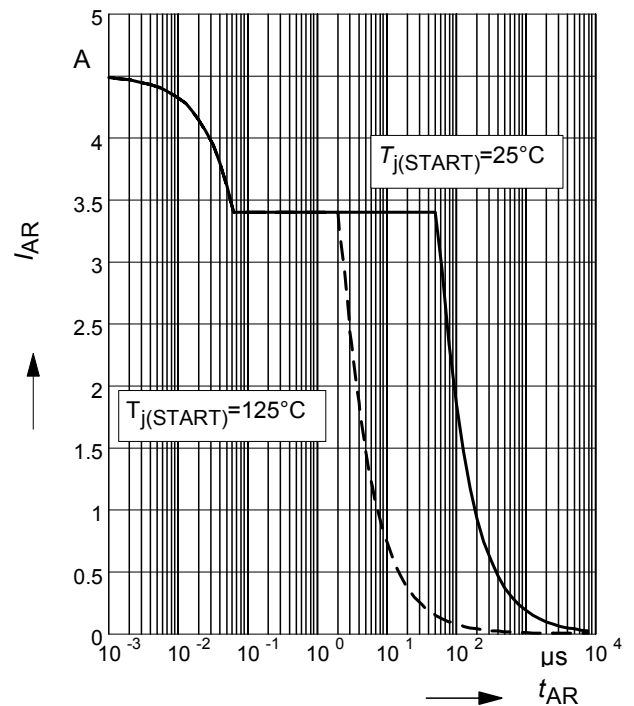

21 Avalanche energy

$$E_{AS} = f(T_j)$$

par.: $I_D = 3.4$, $V_{DD} = 50$ V

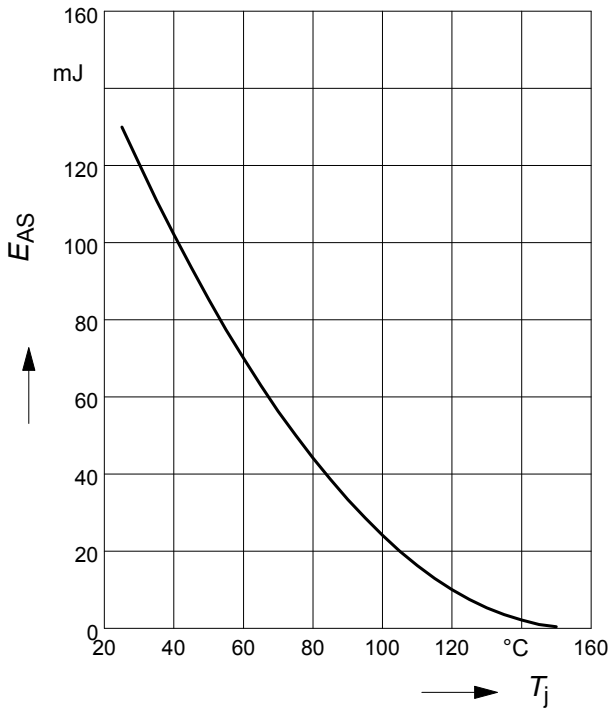

22 Drain-source breakdown voltage

$$V_{(BR)DSS} = f(T_j)$$

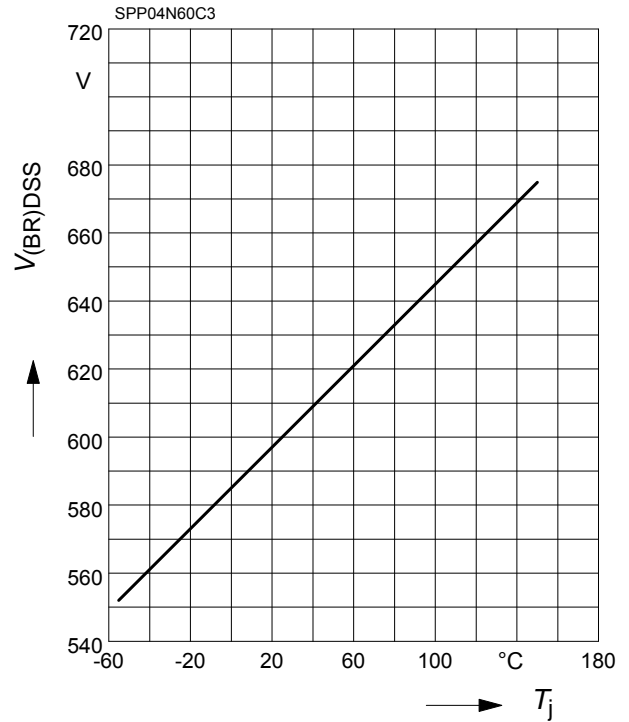

23 Avalanche power losses

$$P_{AR} = f(f)$$

parameter: $E_{AR}=0.4$ mJ

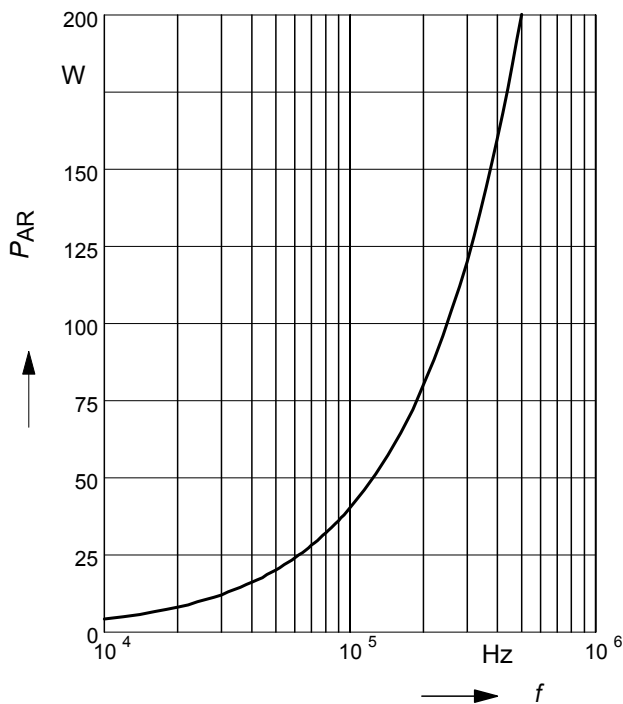

24 Typ. capacitances

$$C = f(V_{DS})$$

parameter: $V_{GS}=0$ V, $f=1$ MHz

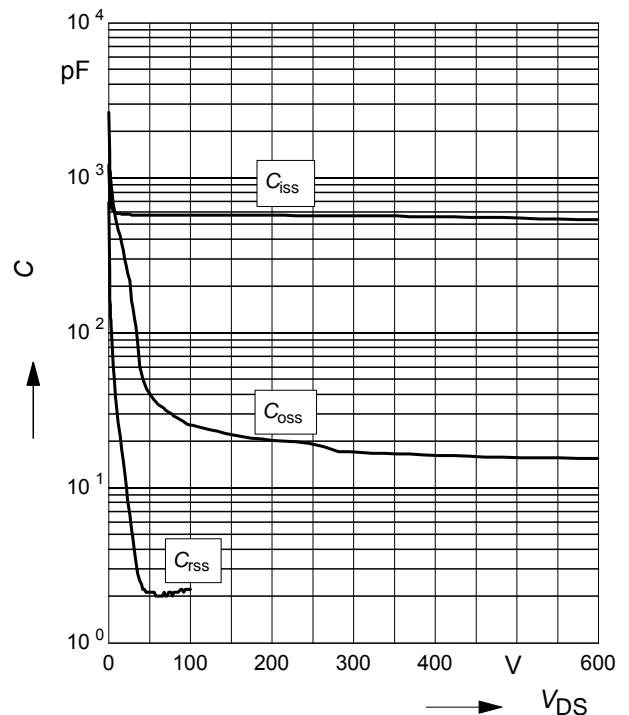

25 Typ. C_{OSS} stored energy

$$E_{OSS} = f(V_{DS})$$

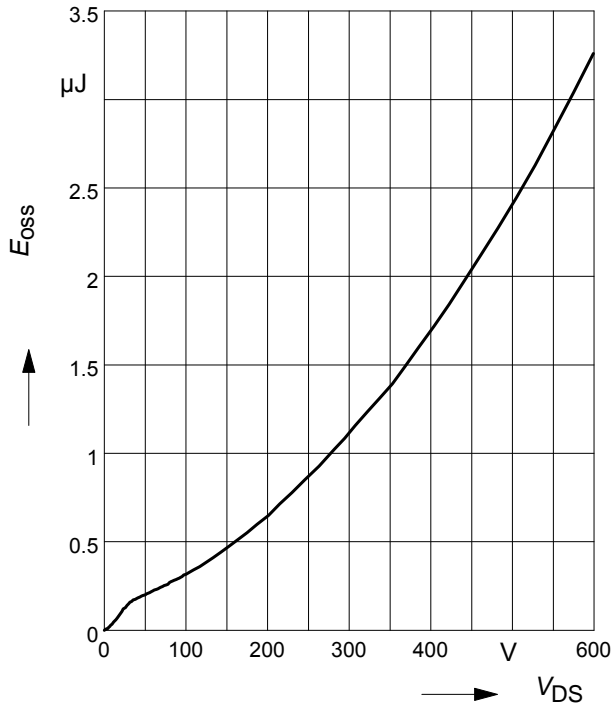

Definition of diodes switching characteristics

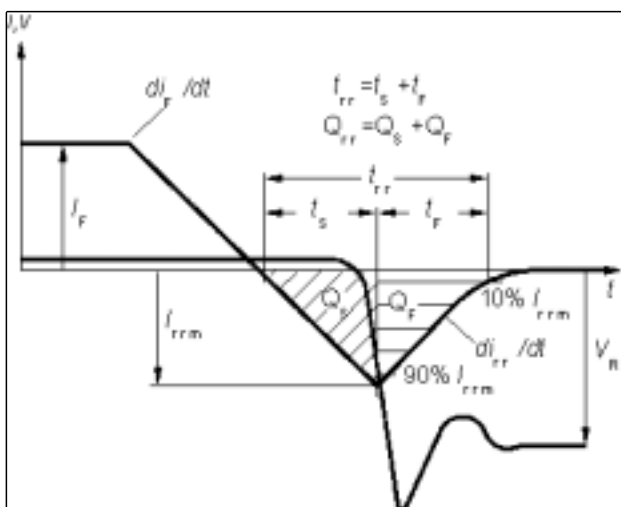

P-TO-220-3-1

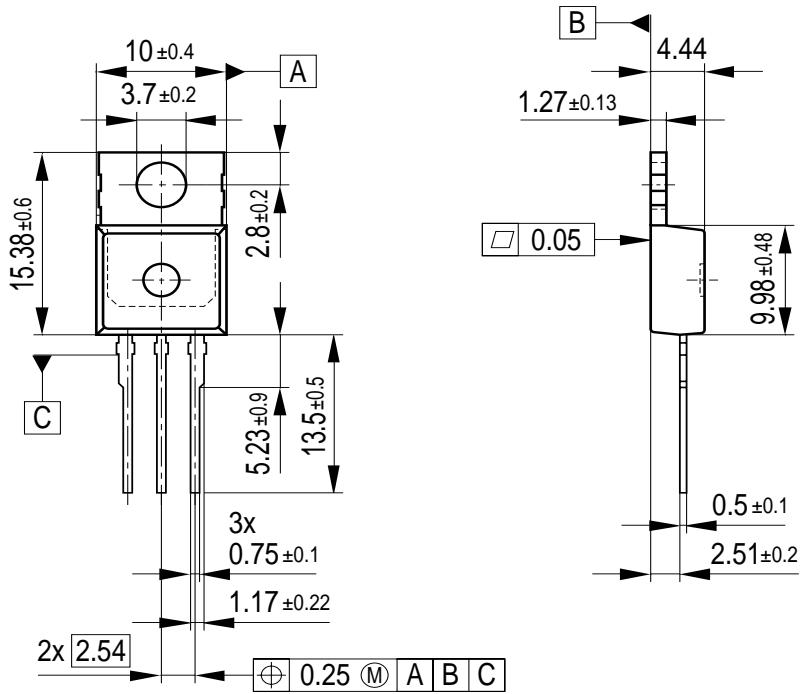

All metal surfaces tin plated, except area of cut.
Metal surface min. x=7.25, y=12.3

P-TO-263-3-2 (D²-PAK)

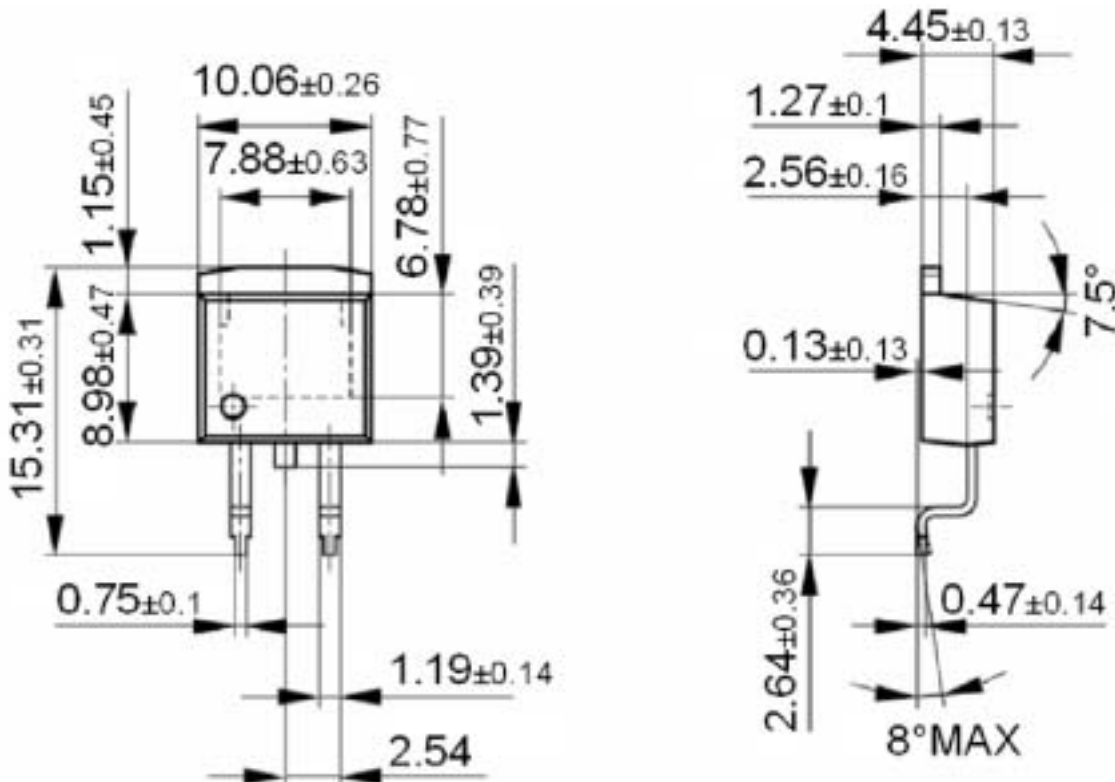

P-TO-220-3-31 (FullPAK)

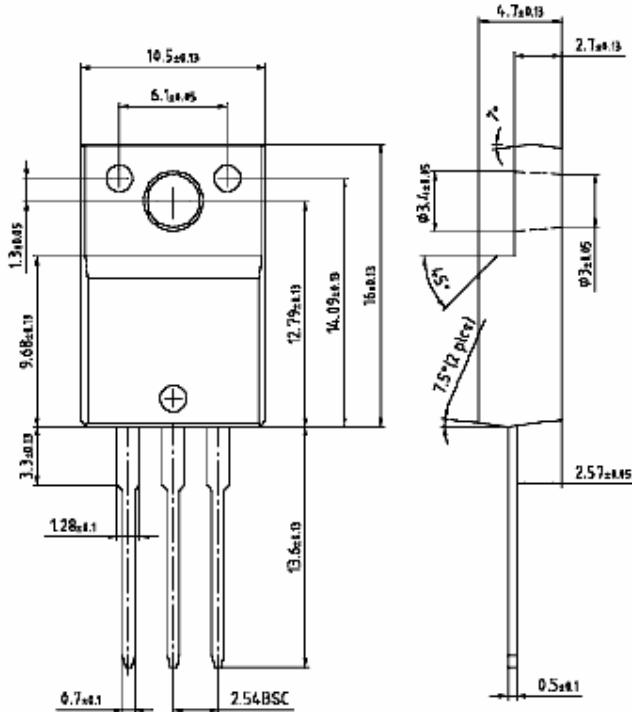

Please refer to mounting instructions (application note AN-TO220-3-31-01)

Published by
Infineon Technologies AG,
Bereichs Kommunikation
St.-Martin-Strasse 53,
D-81541 München
© Infineon Technologies AG 1999
All Rights Reserved.

Attention please!

The information herein is given to describe certain components and shall not be considered as warranted characteristics.

Terms of delivery and rights to technical change reserved.

We hereby disclaim any and all warranties, including but not limited to warranties of non-infringement, regarding circuits, descriptions and charts stated herein.

Infineon Technologies is an approved CECC manufacturer.

Information

For further information on technology, delivery terms and conditions and prices please contact your nearest Infineon Technologies Office in Germany or our Infineon Technologies Representatives worldwide (see address list).

Warnings

Due to technical requirements components may contain dangerous substances.

For information on the types in question please contact your nearest Infineon Technologies Office.

Infineon Technologies Components may only be used in life-support devices or systems with the express written approval of Infineon Technologies, if a failure of such components can reasonably be expected to cause the failure of that life-support device or system, or to affect the safety or effectiveness of that device or system. Life support devices or systems are intended to be implanted in the human body, or to support and/or maintain and sustain and/or protect human life. If they fail, it is reasonable to assume that the health of the user or other persons may be endangered.