

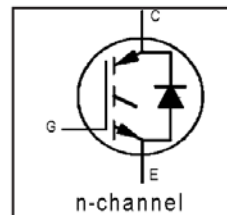
# IRG4PSC71KDPbF

INSULATED GATE BIPOLAR TRANSISTOR WITH  
ULTRAFAST SOFT RECOVERY DIODE

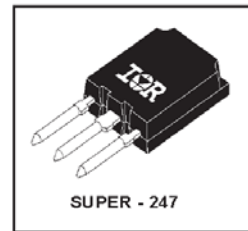
Short Circuit Rated  
UltraFast IGBT

## Features

- Hole-less clip/pressure mount package compatible with TO-247 and TO-264, with reinforced pins
- High short circuit rating IGBTs, optimized for motorcontrol
- Minimum switching losses combined with low conduction losses
- Tightest parameter distribution
- IGBT co-packaged with ultrafast soft recovery antiparallel diode
- Creepage distance increased to 5.35mm
- Lead-Free



$V_{CES} = 600V$
$V_{CE(on)} \text{ typ.} = 1.83V$
@ $V_{GE} = 15V, I_C = 60A$



## Benefits

- Highest current rating copack IGBT
- Maximum power density, twice the power handling of the TO-247, less space than TO-264
- HEXFRED™ diode optimized for operation with IGBT, to minimize EMI, noise and switching losses

## Absolute Maximum Ratings

	Parameter	Max.	Units
$V_{CES}$	Collector-to-Emitter Voltage	600	V
$I_C @ T_C = 25^\circ C$	Continuous Collector Current	85 <sup>⑤</sup>	A
$I_C @ T_C = 100^\circ C$	Continuous Collector Current	60	
$I_{CM}$	Pulsed Collector Current ①	200	
$I_{LM}$	Clamped Inductive Load Current ②	200	
$I_F @ T_C = 100^\circ C$	Diode Continuous Forward Current	50	
$I_{FM}$	Diode Maximum Forward Current	200	
$t_{SC}$	Short Circuit Withstand Time	10	$\mu s$
$V_{GE}$	Gate-to-Emitter Voltage	$\pm 20$	V
$P_D @ T_C = 25^\circ C$	Maximum Power Dissipation	350	W
$P_D @ T_C = 100^\circ C$	Maximum Power Dissipation	140	
$T_J$	Operating Junction and	-55 to +150	$^\circ C$
$T_{STG}$	Storage Temperature Range		
	Soldering Temperature, for 10 sec.	300 (0.063 in. (1.6mm) from case)	

## Thermal Resistance\ Mechanical

	Parameter	Min.	Typ.	Max.	Units
$R_{\theta JC}$	Junction-to-Case - IGBT	---	---	0.36	$^\circ C/W$
$R_{\theta JC}$	Junction-to-Case - Diode	---	---	0.69	
$R_{\theta CS}$	Case-to-Sink, flat, greased surface	---	0.24	---	
$R_{\theta JA}$	Junction-to-Ambient, typical socket mount	---	---	38	
	Recommended Clip Force	20.0(2.0)	---	---	N (kgf)
	Weight	---	6 (0.21)	---	g (oz)

# IRG4PSC71KDPbF

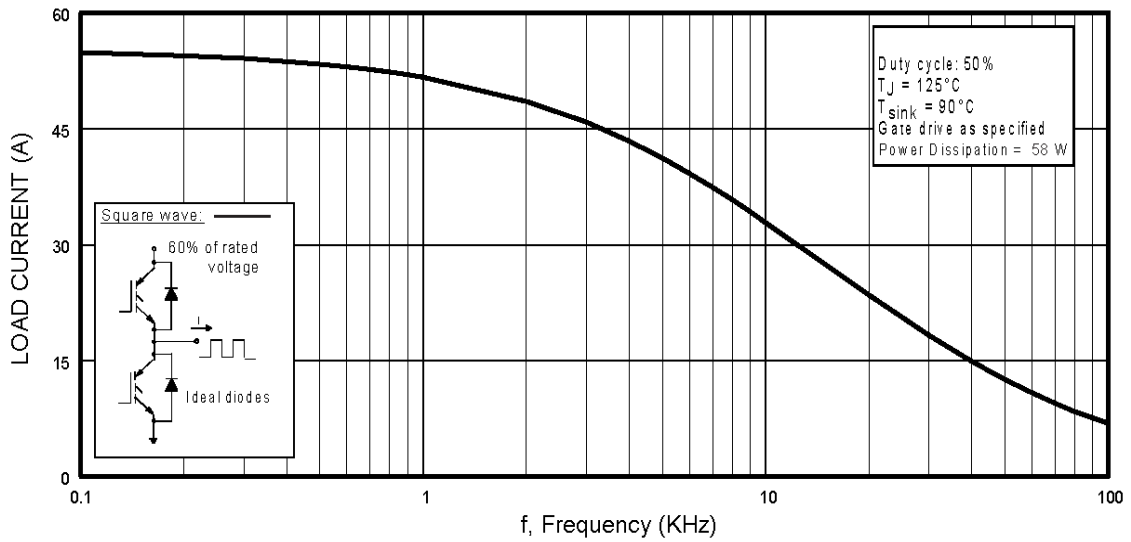
International  
**IR** Rectifier

## Electrical Characteristics @ T<sub>J</sub> = 25°C (unless otherwise specified)

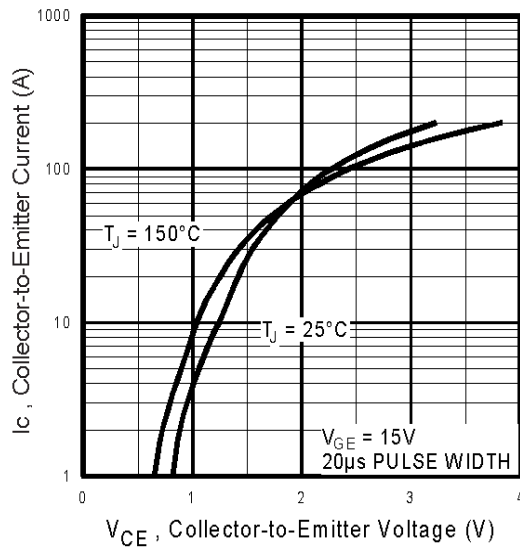
	Parameter	Min.	Typ.	Max.	Units	Conditions
V <sub>(BR)CES</sub>	Collector-to-Emitter Breakdown Voltage <sup>③</sup>	600	—	—	V	V <sub>GE</sub> = 0V, I <sub>C</sub> = 250μA
ΔV <sub>(BR)CES</sub> /ΔT <sub>J</sub>	Temperature Coeff. of Breakdown Voltage	—	0.5	—	V/°C	V <sub>GE</sub> = 0V, I <sub>C</sub> = 10mA
V <sub>CE(on)</sub>	Collector-to-Emitter Saturation Voltage	—	1.83	2.3	V	I <sub>C</sub> = 60A I <sub>C</sub> = 100A I <sub>C</sub> = 60A, T <sub>J</sub> = 150°C V <sub>GE</sub> = 15V See Fig. 2, 5
		—	2.20	—		
		—	1.81	—		
V <sub>GE(th)</sub>	Gate Threshold Voltage	3.0	—	6.0		V <sub>CE</sub> = V <sub>GE</sub> , I <sub>C</sub> = 250μA
ΔV <sub>GE(th)</sub> /ΔT <sub>J</sub>	Temperature Coeff. of Threshold Voltage	—	-8.0	—	mV/°C	V <sub>CE</sub> = V <sub>GE</sub> , I <sub>C</sub> = 1.5mA
g <sub>fe</sub>	Forward Transconductance <sup>④</sup>	31	46	—	S	V <sub>CE</sub> = 50V, I <sub>C</sub> = 60A
I <sub>CES</sub>	Zero Gate Voltage Collector Current	—	—	500	μA	V <sub>GE</sub> = 0V, V <sub>CE</sub> = 600V
		—	—	13	mA	V <sub>GE</sub> = 0V, V <sub>CE</sub> = 600V, T <sub>J</sub> = 150°C
V <sub>FM</sub>	Diode Forward Voltage Drop	—	1.4	1.7	V	I <sub>C</sub> = 60A I <sub>C</sub> = 60A, T <sub>J</sub> = 150°C See Fig. 13
		—	1.3	—		
I <sub>GES</sub>	Gate-to-Emitter Leakage Current	—	—	±100	nA	V <sub>GE</sub> = ±20V

## Switching Characteristics @ T<sub>J</sub> = 25°C (unless otherwise specified)

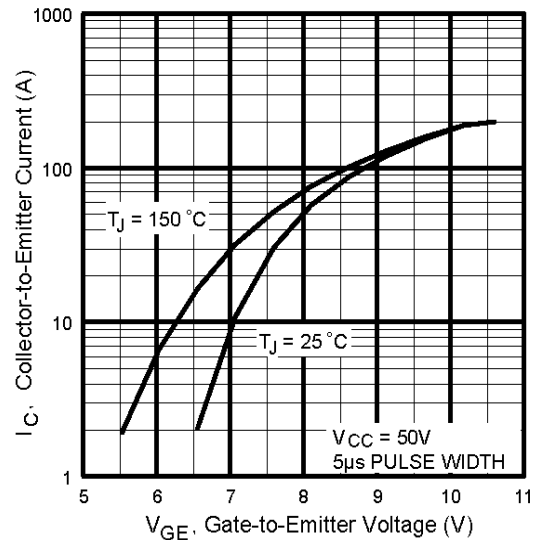
	Parameter	Min.	Typ.	Max.	Units	Conditions
Q <sub>g</sub>	Total Gate Charge (turn-on)	—	340	510	nC	I <sub>C</sub> = 60A V <sub>CC</sub> = 400V V <sub>GE</sub> = 15V See Fig. 8
Q <sub>ge</sub>	Gate - Emitter Charge (turn-on)	—	44	66		
Q <sub>gc</sub>	Gate - Collector Charge (turn-on)	—	160	240		
t <sub>d(on)</sub>	Turn-On Delay Time	—	82	—	ns	T <sub>J</sub> = 25°C I <sub>C</sub> = 60A, V <sub>CC</sub> = 480V V <sub>GE</sub> = 15V, R <sub>G</sub> = 5.0Ω Energy losses include "tail" and diode reverse recovery See Fig. 9,10,18
t <sub>r</sub>	Rise Time	—	107	—		
t <sub>d(off)</sub>	Turn-Off Delay Time	—	282	423		
t <sub>f</sub>	Fall Time	—	97	146		
E <sub>on</sub>	Turn-On Switching Loss	—	3.95	—	mJ	V <sub>CC</sub> = 360V, T <sub>J</sub> = 125°C V <sub>GE</sub> = 15V, R <sub>G</sub> = 5.0Ω, V <sub>CPK</sub> < 500V
E <sub>off</sub>	Turn-Off Switching Loss	—	2.33	—		
E <sub>ts</sub>	Total Switching Loss	—	6.28	7.7		
t <sub>sc</sub>	Short Circuit Withstand Time	10	—	—	μs	
t <sub>d(on)</sub>	Turn-On Delay Time	—	87	—	ns	T <sub>J</sub> = 150°C, See Fig. 11,18 I <sub>C</sub> = 60A, V <sub>CC</sub> = 480V V <sub>GE</sub> = 15V, R <sub>G</sub> = 5.0Ω Energy losses include "tail" and diode reverse recovery
t <sub>r</sub>	Rise Time	—	104	—		
t <sub>d(off)</sub>	Turn-Off Delay Time	—	374	—		
t <sub>f</sub>	Fall Time	—	143	—		
E <sub>ts</sub>	Total Switching Loss	—	8.5	—	mJ	
L <sub>E</sub>	Internal Emitter Inductance	—	13	—	nH	Measured 5mm from package
C <sub>ies</sub>	Input Capacitance	—	6900	—	pF	V <sub>GE</sub> = 0V V <sub>CC</sub> = 30V f = 1.0MHz See Fig. 7
C <sub>oes</sub>	Output Capacitance	—	730	—		
C <sub>res</sub>	Reverse Transfer Capacitance	—	190	—		
t <sub>rr</sub>	Diode Reverse Recovery Time	—	82	120	ns	T <sub>J</sub> = 25°C See Fig. 14 T <sub>J</sub> = 125°C
		—	140	210		
I <sub>rr</sub>	Diode Peak Reverse Recovery Current	—	8.2	12	A	T <sub>J</sub> = 25°C See Fig. 15 T <sub>J</sub> = 125°C
		—	13	20		
Q <sub>rr</sub>	Diode Reverse Recovery Charge	—	364	546	nC	T <sub>J</sub> = 25°C See Fig. 16 T <sub>J</sub> = 125°C
		—	1084	1625		
di <sub>(rec)M</sub> /dt	Diode Peak Rate of Fall of Recovery During t <sub>b</sub>	—	328	—	A/μs	T <sub>J</sub> = 25°C See Fig. 17 T <sub>J</sub> = 125°C



**Fig. 1** - Typical Load Current vs. Frequency  
 (Load Current =  $I_{\text{RMS}}$  of fundamental)

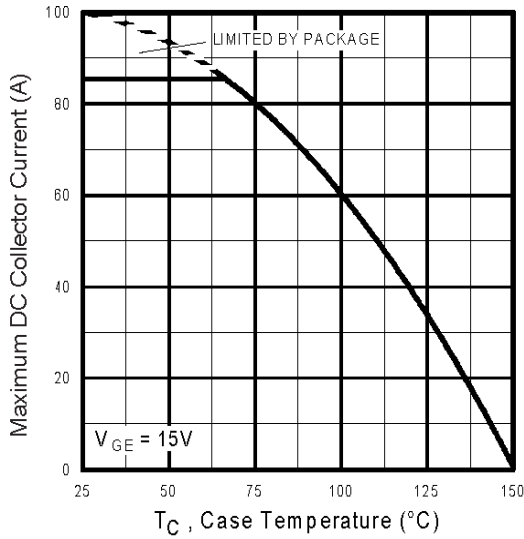


**Fig. 2** - Typical Output Characteristics

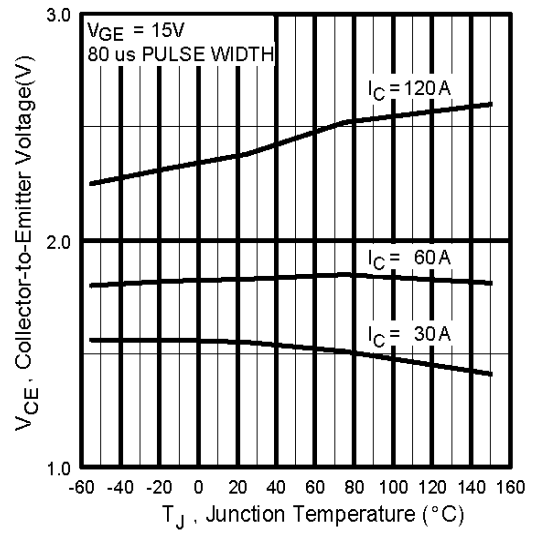


**Fig. 3** - Typical Transfer Characteristics

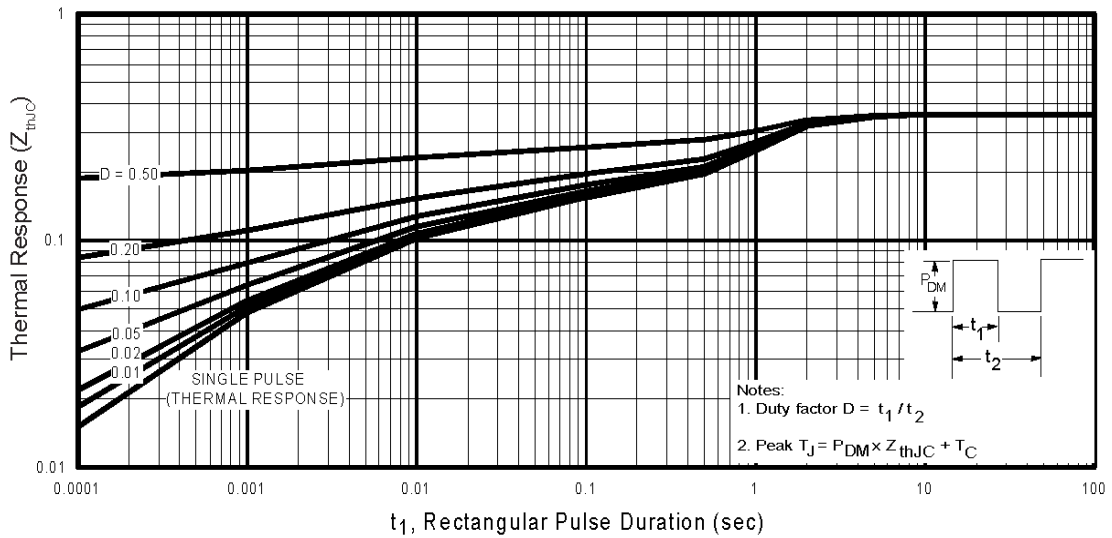
# IRG4PSC71KDPbF



**Fig. 4** - Maximum Collector Current vs. Case Temperature



**Fig. 5** - Typical Collector-to-Emitter Voltage vs. Junction Temperature



**Fig. 6** - Maximum Effective Transient Thermal Impedance, Junction-to-Case

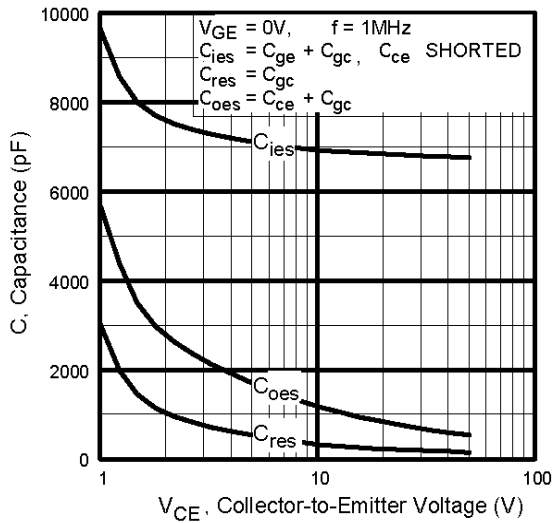


Fig. 7 - Typical Capacitance vs. Collector-to-Emitter Voltage

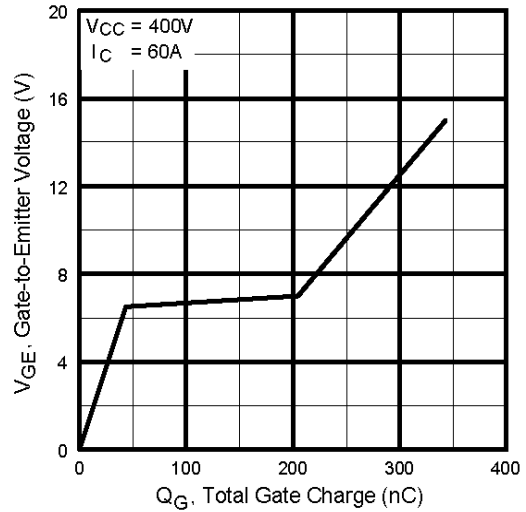


Fig. 8 - Typical Gate Charge vs. Gate-to-Emitter Voltage

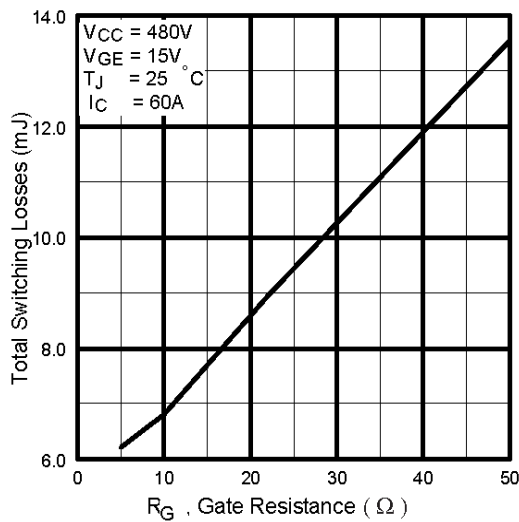


Fig. 9 - Typical Switching Losses vs. Gate Resistance

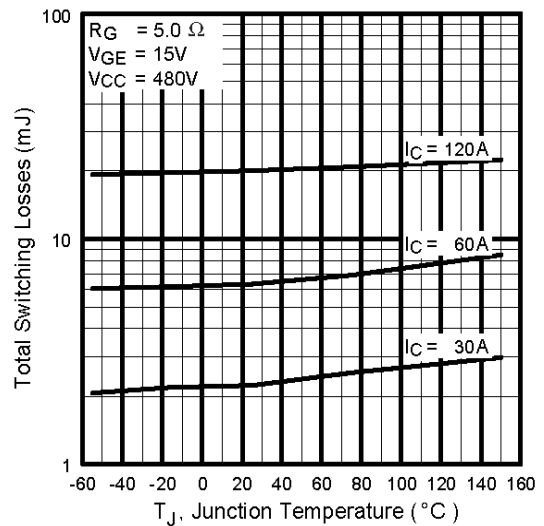
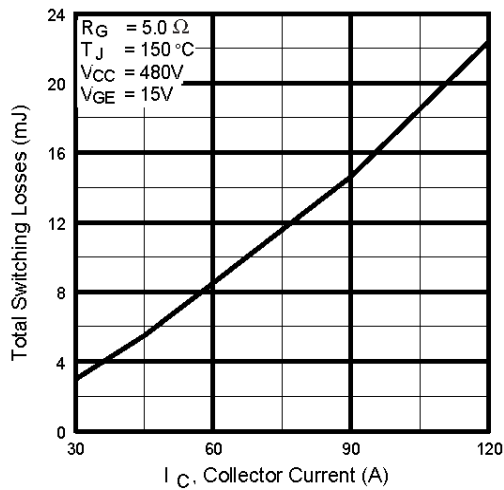


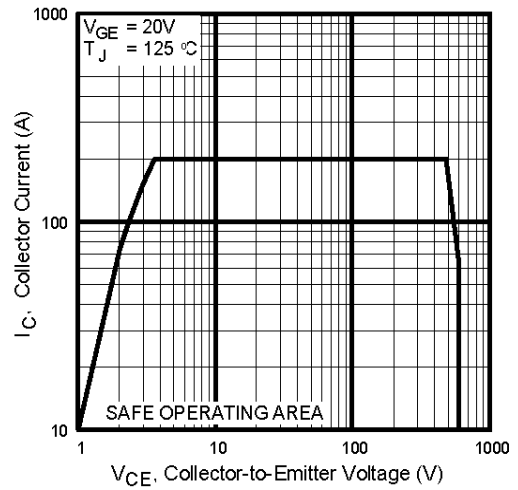
Fig. 10 - Typical Switching Losses vs. Junction Temperature

# IRG4PSC71KDPbF

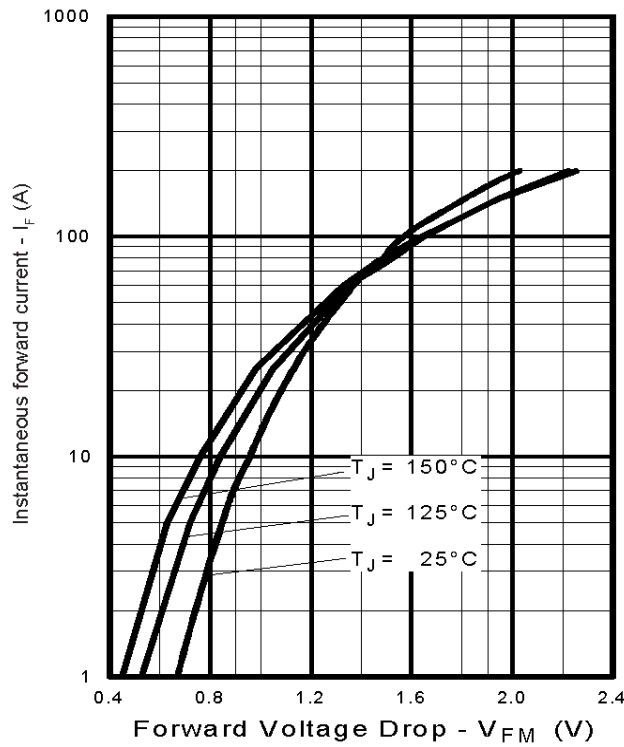
International  
**IR** Rectifier



**Fig. 11** - Typical Switching Losses vs. Collector-to-Emitter Current



**Fig. 12** - Turn-Off SOA



**Fig. 13** - Maximum Forward Voltage Drop vs. Instantaneous Forward Current

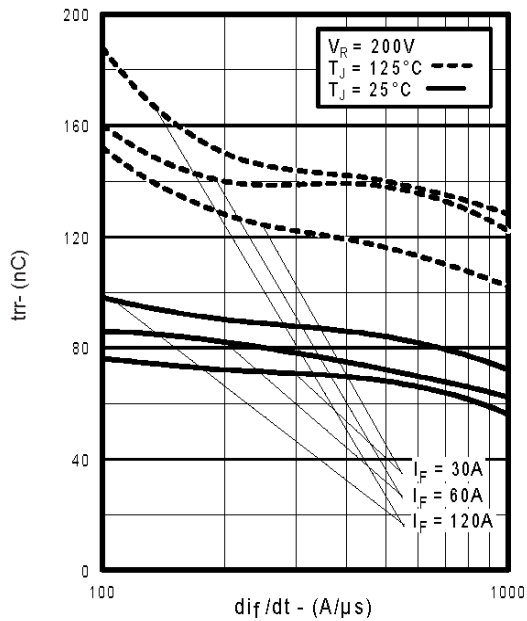


Fig. 14 - Typical Reverse Recovery vs.  $di_f/dt$

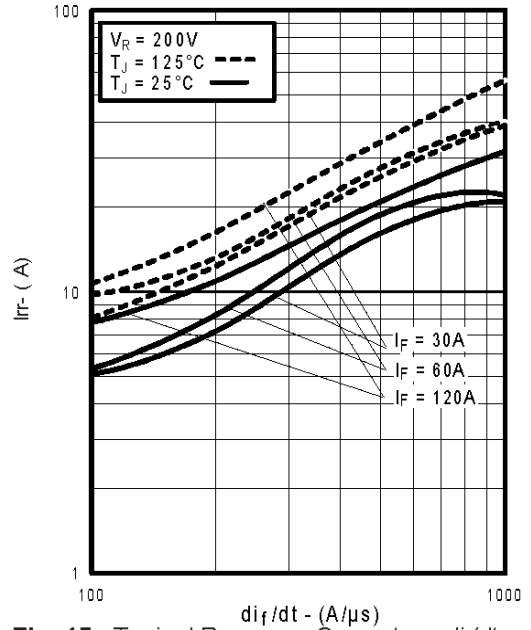


Fig. 15 - Typical Recovery Current vs.  $di_f/dt$

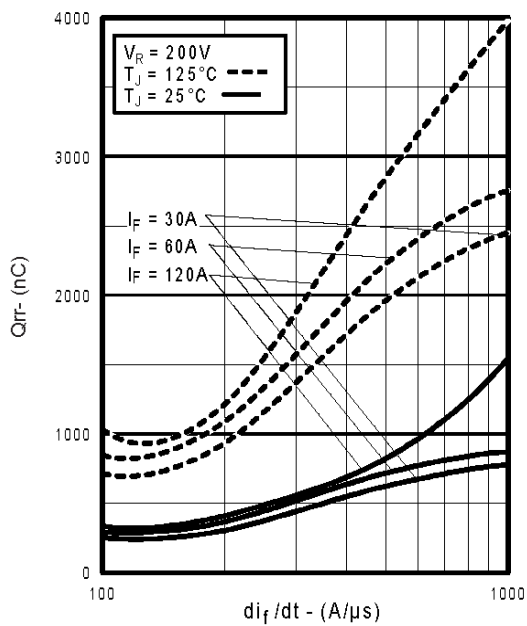


Fig. 16 - Typical Stored Charge vs.  $di_f/dt$   
[www.irf.com](http://www.irf.com)

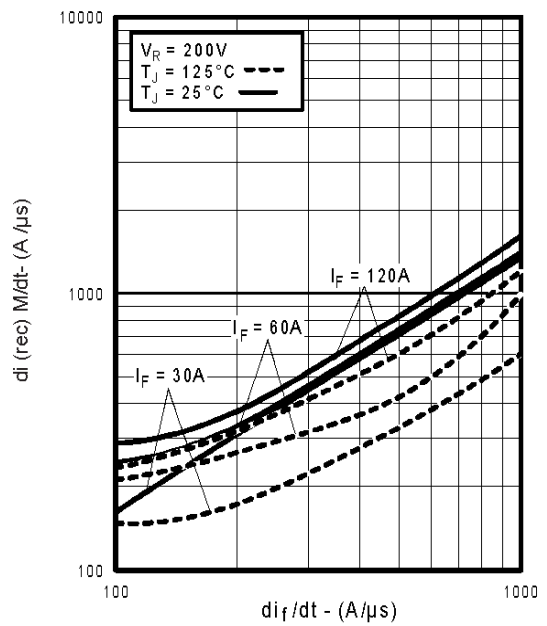
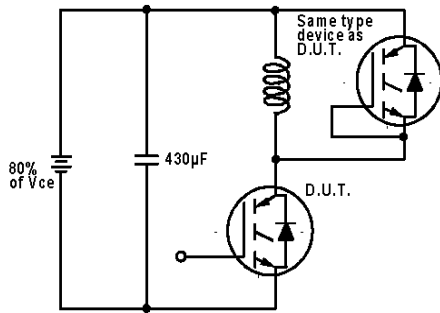
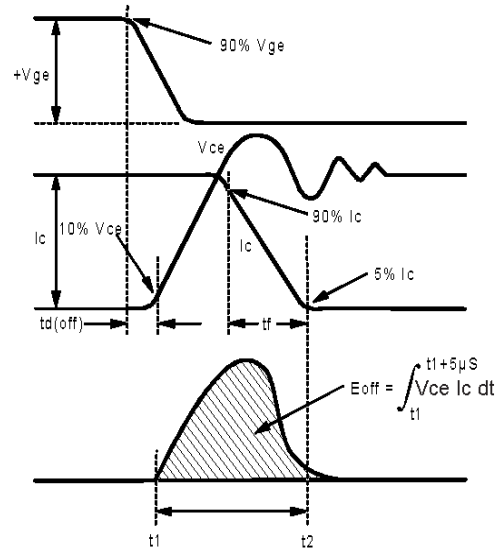


Fig. 17 - Typical  $di_{(rec)M}/dt$  vs.  $di_f/dt$

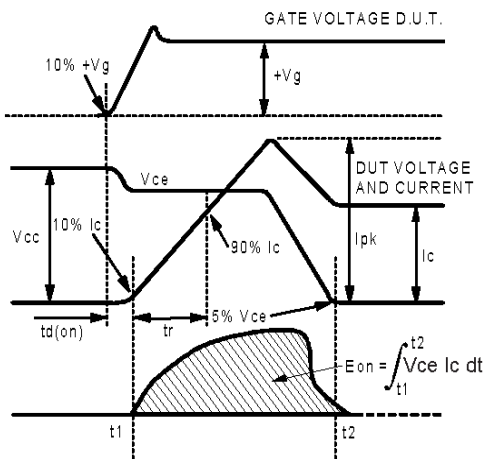
# IRG4PSC71KDPbF



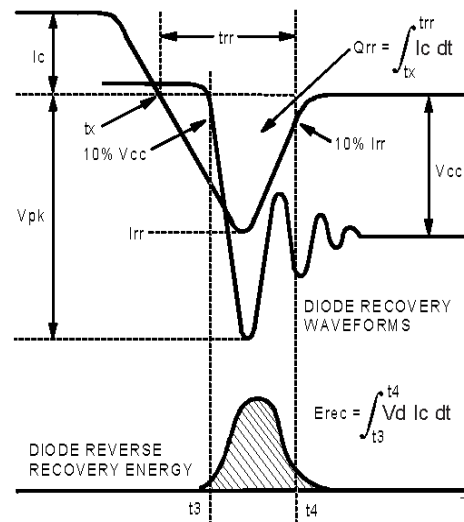
**Fig. 18a** - Test Circuit for Measurement of  $I_{LM}$ ,  $E_{on}$ ,  $E_{off}(\text{diode})$ ,  $t_{rr}$ ,  $Q_{rr}$ ,  $I_{rr}$ ,  $t_{d(on)}$ ,  $t_r$ ,  $t_{d(off)}$ ,  $t_f$



**Fig. 18b** - Test Waveforms for Circuit of Fig. 18a, Defining  $E_{off}$ ,  $t_{d(off)}$ ,  $t_f$



**Fig. 18c** - Test Waveforms for Circuit of Fig. 18a, Defining  $E_{on}$ ,  $t_{d(on)}$ ,  $t_r$



**Fig. 18d** - Test Waveforms for Circuit of Fig. 18a, Defining  $E_{rec}$ ,  $t_{rr}$ ,  $Q_{rr}$ ,  $I_{rr}$



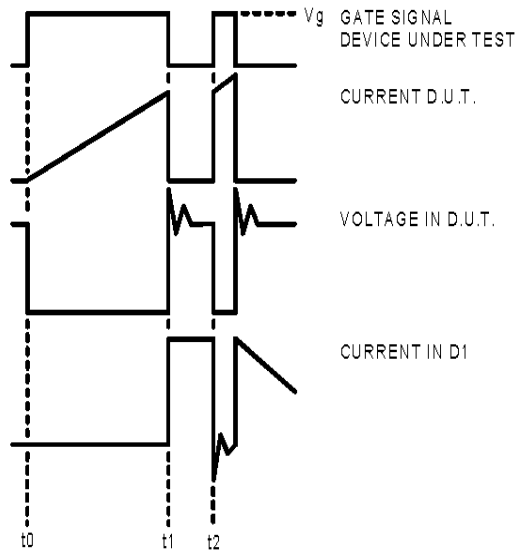


Figure 18e. Macro Waveforms for Figure 18a's Test Circuit

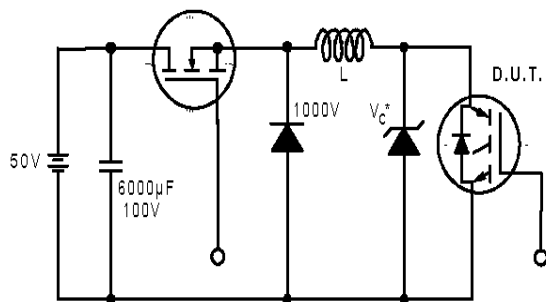


Figure 19. Clamped Inductive Load Test Circuit

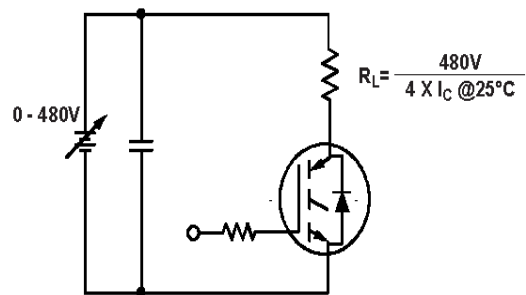
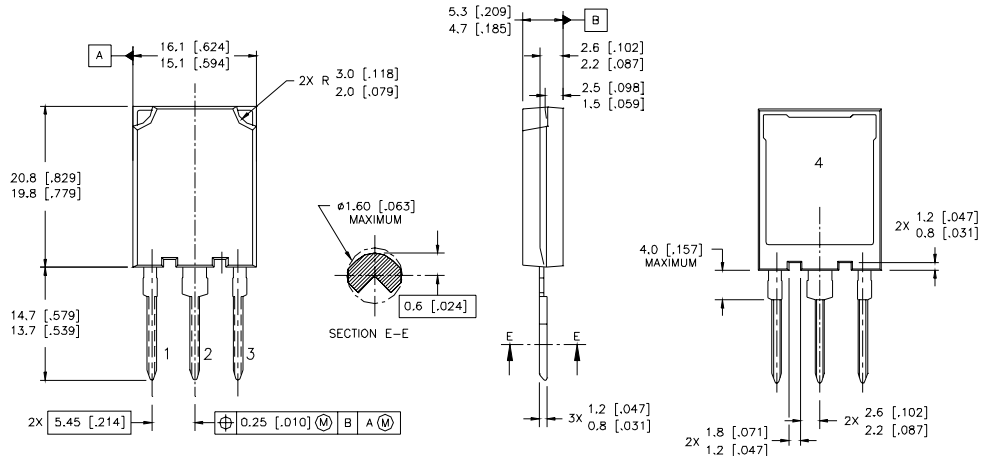


Figure 20. Pulsed Collector Current Test Circuit

# IRG4PSC71KDPbF

International  
**IR** Rectifier

## Case Outline and Dimensions — Super-247

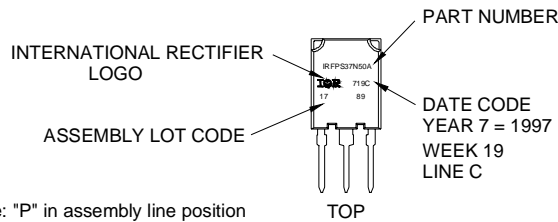


NOTES:  
 1. DIMENSIONS & TOLERANCING PER ASME Y14.5M-1994  
 2. CONTROLLING DIMENSION: MILLIMETER  
 3. DIMENSIONS ARE SHOWN IN MILLIMETRES [INCHES]

LEAD ASSIGNMENTS	
MOSFET	IGBT
1 - GATE	1 - GATE
2 - DRAIN	2 - COLLECTOR
3 - SOURCE	3 - EMITTER
4 - DRAIN	4 - COLLECTOR

## Super-247 (TO-274AA) Part Marking Information

EXAMPLE: THIS IS AN IRFPS37N50A WITH  
 ASSEMBLY LOT CODE 1789  
 ASSEMBLED ON WW 19, 1997  
 IN THE ASSEMBLY LINE "C"



- Notes:**
- ① Repetitive rating:  $V_{GE}=20V$ ; pulse width limited by maximum junction temperature (figure 20)
  - ②  $V_{CC}=80\%(V_{CES})$ ,  $V_{GE}=20V$ ,  $L=10\mu H$ ,  $R_G=5.0\Omega$  (figure 19)
  - ③ Pulse width  $\leq 80\mu s$ ; duty factor  $\leq 0.1\%$
  - ④ Pulse width  $5.0\mu s$ , single shot
  - ⑤ Current limited by the package. (Die current = 100A)

Data and specifications subject to change without notice.

International  
**IR** Rectifier

IR WORLD HEADQUARTERS: 233 Kansas St., El Segundo, California 90245, USA Tel: (310) 252-7105  
 TAC Fax: (310) 252-7903

Visit us at [www.irf.com](http://www.irf.com) for sales contact information. 09/04

[www.irf.com](http://www.irf.com)