

MMBT3904-HF (NPN)

RoHS Device
Halogen Free

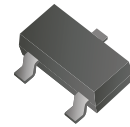

Features

- Epitaxial planar die construction
- As complementary type, the PNP transistor MMBT3904-HF is recommended

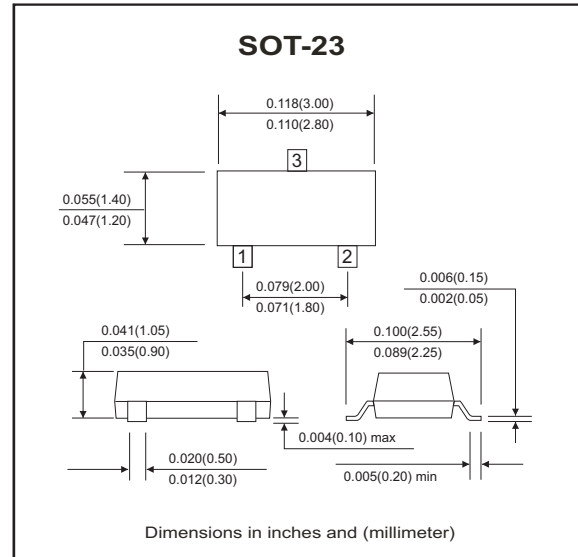
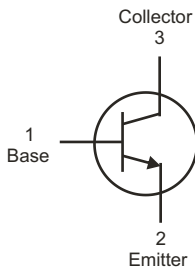

Maximum Ratings (at TA=25°C unless otherwise noted)

Parameter	Symbol	Min	Typ	Max	Unit
Collector-Base voltage	V_{CBO}			60	V
Collector-Emitter voltage	V_{CEO}			40	V
Emitter-Base voltage	V_{EBO}			6	V
Collector current-Continuous	I_C			0.2	A
Collector dissipation	P_C			0.2	W
Thermal resistance, junction to ambient	$R_{\theta JA}$			625	°C/W
Storage temperature and junction temperature	T_{STG}, T_J	-55		+150	°C

Electrical Characteristics (at TA=25°C unless otherwise noted)

Parameter	Conditions	Symbol	Min	Max	Unit
Collector-Base breakdown voltage	$I_C = 100\mu A, I_E = 0$	$V_{(BR)CBO}$	60		V
Collector-Emitter breakdown voltage	$I_C = 1mA, I_B = 0$	$V_{(BR)CEO}$	40		V
Emitter-Base breakdown voltage	$I_E = 100\mu A, I_C = 0$	$V_{(BR)EBO}$	6		V
Collector cut-off current	$V_{CB} = 60V, I_E = 0$	I_{CBO}		0.1	μA
Collector cut-off current	$V_{CE} = 30V, V_{BE(off)} = 3V$	I_{CEX}		50	nA
Emitter cut-off current	$V_{EB} = 5V, I_C = 0$	I_{EBO}		0.1	μA
DC current gain	$V_{CE} = 1V, I_C = 10mA$	$h_{FE(1)}$	100	400	
	$V_{CE} = 1V, I_C = 50mA$	$h_{FE(2)}$	60		
Collector-Emitter saturation voltage	$I_C = 50mA, I_B = 5mA$	$V_{CE(sat)}$		0.3	V
Base-Emitter saturation voltage	$I_C = 50mA, I_B = 5mA$	$V_{BE(sat)}$		0.95	V
Transition frequency	$V_{CE} = 20V, I_C = 10mA$ $f = 100MHz$	f_T	300		Mhz
Delay time	$V_{CC} = 3.0V, V_{BE} = -0.5V$	t_d		35	nS
Rise time	$I_C = 10mA, I_{B1} = 1.0mA$	t_r		35	nS
Storage time	$V_{CC} = 3.0V, I_C = 10mA$	t_s		200	nS
Fall time	$I_{B1} = I_{B2} = 1.0mA$	t_f		50	nS

RATING AND CHARACTERISTIC CURVES (MMBT3904-HF)

Fig.1 Typical pulsed current gain V.S. Collector current

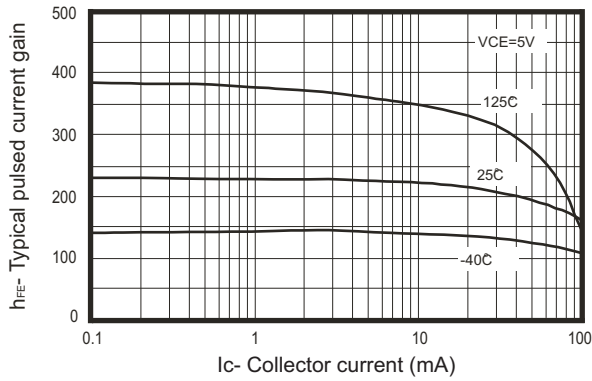

Fig.2 Collector-Emitter saturation voltage V.S. Collector current

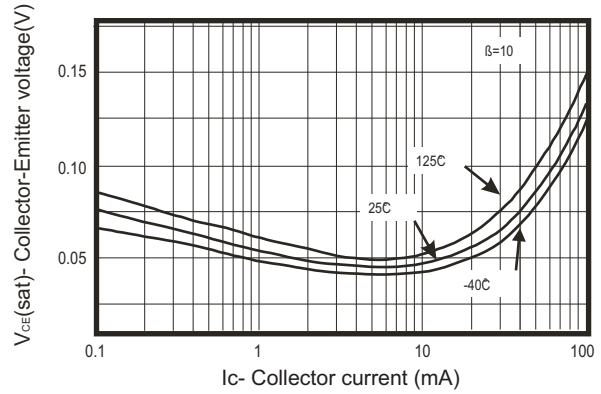

Fig.3 Base-Emitter saturation voltage V.S. Collector current

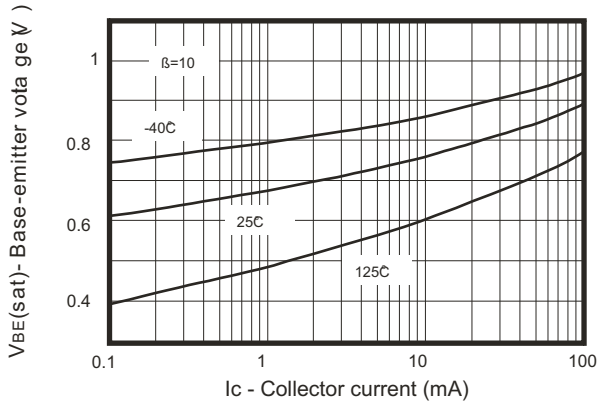

Fig.4 Base-Emitter ON voltage V.S. Collector current

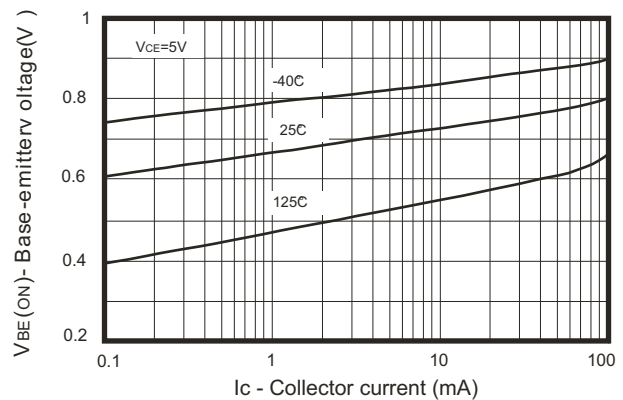

Fig.5 Collector-cutoff current V.S. Ambient temperature

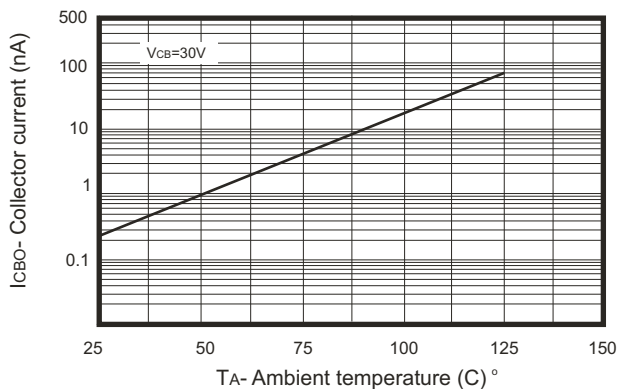
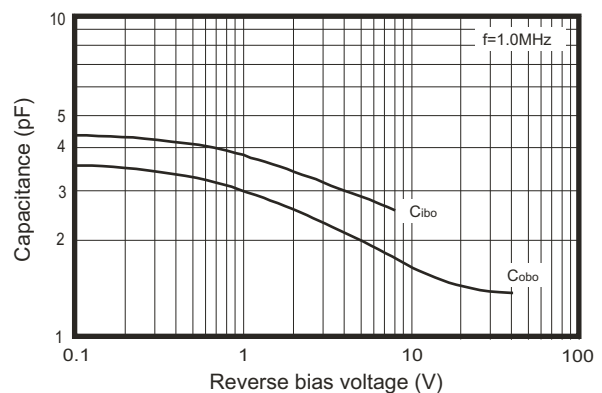
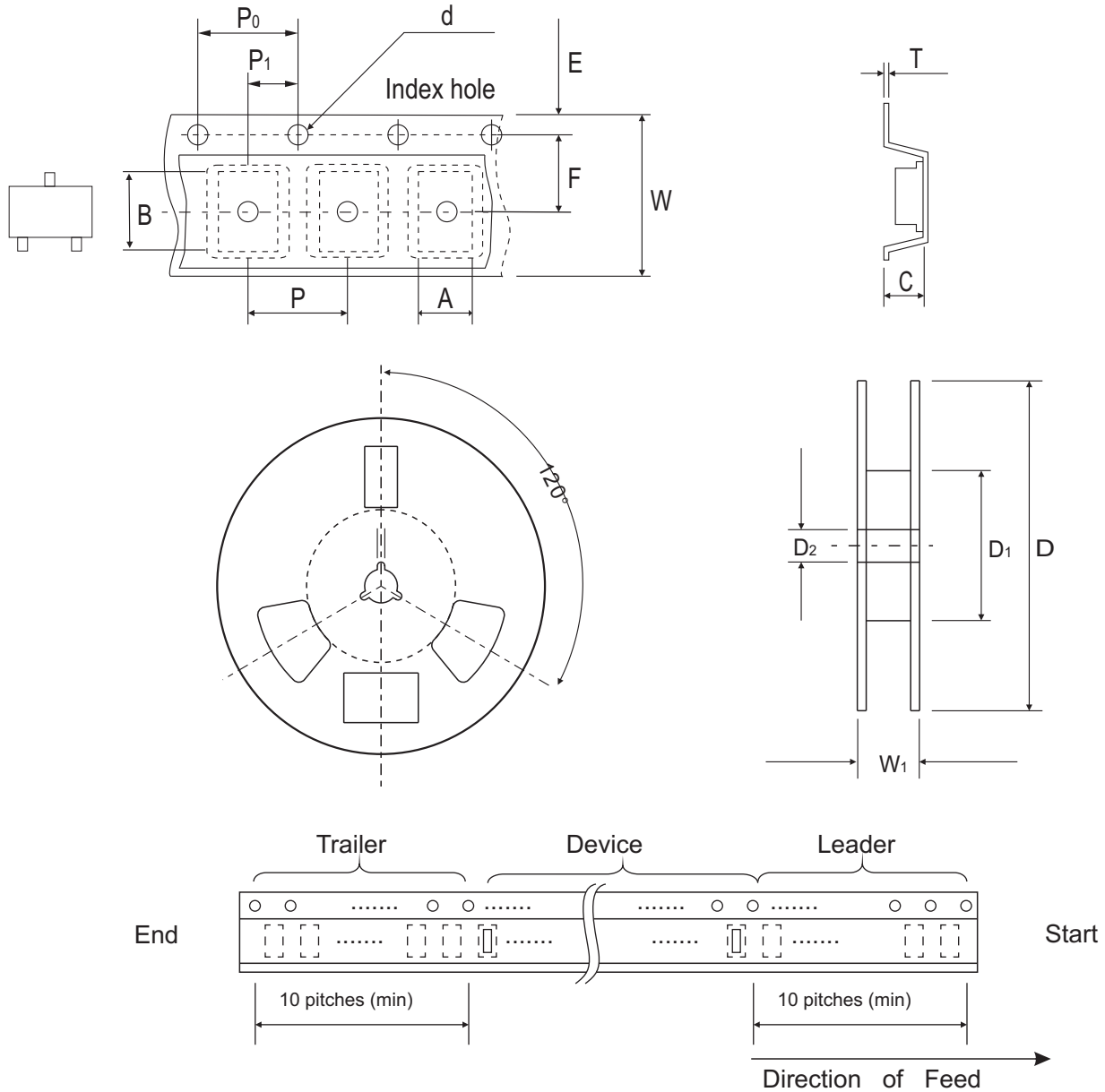

Fig.6 Capacitance V.S. Reverse bias voltage



Reel Taping Specification



SOT-23	SYMBOL	A	B	C	d	D	D ₁	D ₂
	(mm)	3.10 ± 0.10	2.85 ± 0.10	1.40 ± 0.10	1.55 ± 0.10	178 ± 1	50.0 MIN.	13.0 ± 0.20
	(inch)	0.122 ± 0.004	0.112 ± 0.004	0.055 ± 0.004	0.061 ± 0.004	7.008 ± 0.04	1.969 MIN.	0.512 ± 0.008

SOT-23	SYMBOL	E	F	P	P ₀	P ₁	W	W ₁
	(mm)	1.75 ± 0.10	3.50 ± 0.05	4.00 ± 0.10	4.00 ± 0.10	2.00 ± 0.05	8.00 ± 0.30	14.4 MAX.
	(inch)	0.069 ± 0.004	0.138 ± 0.002	0.157 ± 0.004	0.157 ± 0.004	0.079 ± 0.004	0.315 ± 0.008	0.567 MAX.

Marking Code

Park Number	Marking Code
MMBT3904-HF	1AM

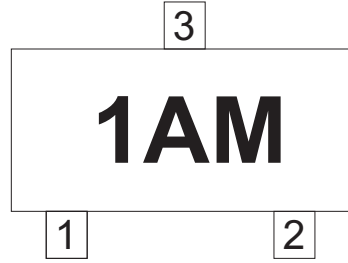

Suggested PAD Layout

SIZE	SOT-23	
	(mm)	(inch)
A	0.80	0.031
B	0.95	0.037
C	0.95	0.037
D	2.02	0.080
E	3.03	0.120

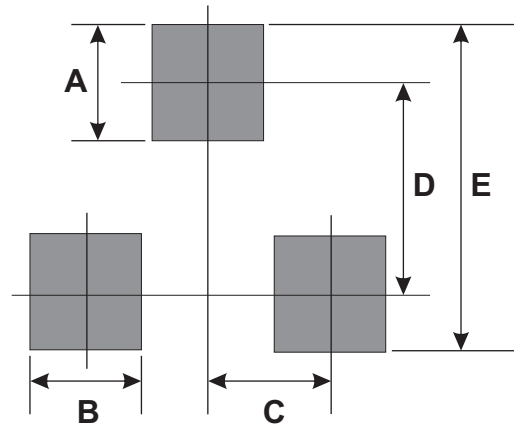

Standard Packaging

Case Type	Qty per Reel	Reel Size
	(Pcs)	(inch)
SOT-23	3000	7