

FFD08S60S_F085

STEALTH™ II Rectifier

Features

- High Speed Switching (Max. $t_{rr} < 30\text{ns}$ @ $I_F = 8\text{A}$)
- High Reverse Voltage and High Reliability
- Avalanche Energy Rated
- Qualified to AEC Q101
- RoHS Compliant

Applications

- General Purpose
- Switching Mode Power Supply
- Boost Diode in continuous mode power factor corrections
- Power switching circuits

8A, 600V Stealth2 Rectifier

The FFD08S60S_F085 is stealth 2 rectifier with soft recovery characteristics ($t_{rr} < 30\text{ns}$). They has half the recovery time of hyperfast rectifier and are silicon nitride passivated ion-implanted epitaxial planar construction. This device is intended for use as freewheeling of boost diode in switching power supplies and other power switching applications. Their low stored charge and hyperfast soft recovery minimize ringing and electrical noise in many power switching circuits reducing power loss in the switching transistors.



Pin Assignments

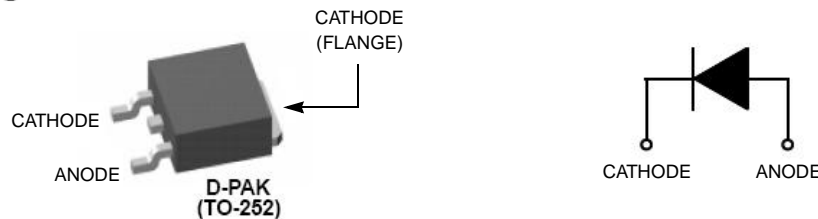

Absolute Maximum Ratings $T_C = 25^\circ\text{C}$ unless otherwise noted

Symbol	Parameter	Ratings	Units
V_{RRM}	Peak Repetitive Reverse Voltage	600	V
V_{RWM}	Working Peak Reverse Voltage	600	V
V_R	DC Blocking Voltage	600	V
$I_{F(AV)}$	Average Rectified Forward Current @ $T_C = 115^\circ\text{C}$	8	A
I_{FSM}	Non-repetitive Peak Surge Current 60Hz Single Half-Sine Wave	80	A
T_J, T_{STG}	Operating Junction and Storage Temperature	-65 to + 150	$^\circ\text{C}$

Thermal Characteristics $T_C = 25^\circ\text{C}$ unless otherwise noted

$R_{\theta JC}$	Maximum Thermal Resistance, Junction to Case	3.0	$^\circ\text{C/W}$
-----------------	----------------------------------------------	-----	--------------------

Package Marking and Ordering Information

Device Marking	Device	Package	Reel Size	Tape Width	Quantity
F08S60S	FFD08S60S_F085	TO252	13"	12mm	2500

Electrical Characteristics $T_C = 25^\circ\text{C}$ unless otherwise noted

Parameter	Test Conditions	Min	Typ	Max	Units
V_{FM}^1	$I_F = 8\text{A}$, $I_F = 8\text{A}$	-	2.1 1.6	2.6 -	V
I_{RM}^1	$V_R = 600\text{V}$, $V_R = 600\text{V}$	-	-	100 500	μA
t_{rr}	$I_F = 1\text{A}$, $di/dt = 100\text{A/s}$, $V_R = 30\text{V}$	-	-	25	ns
t_{rr}	$I_F = 8\text{A}$, $di/dt = 200\text{A/s}$, $V_R = 390\text{V}$	-	19	30	ns
I_{rr}		-	2.2	-	A
S factor		-	0.6	-	
Q_{rr}		-	21	-	nC
t_{rr}	$I_F = 8\text{A}$, $di/dt = 200\text{A/s}$, $V_R = 390\text{V}$	-	58	-	ns
I_{rr}		-	4.3	-	A
S factor		-	1.3	-	
Q_{rr}		-	125	-	nC
W_{AVL}	Avalanche Energy ($L = 40\text{mH}$)	20	-	-	mJ

Notes:

1. Pulse : Test Pulse width = 300us, Duty Cycle = 2%

Test Circuit and Waveforms

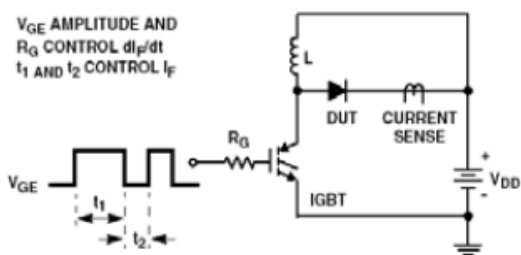

t_{rr} TEST CIRCUIT

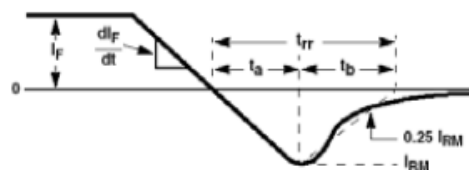

t_{rr} WAVEFORMS AND DEFINITIONS

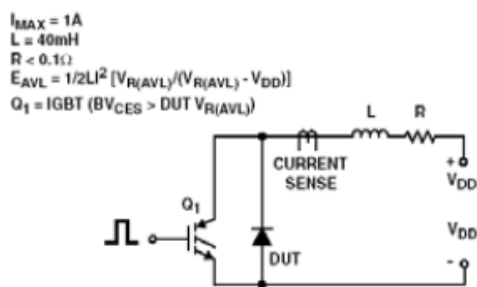

AVALANCHE ENERGY TEST CIRCUIT

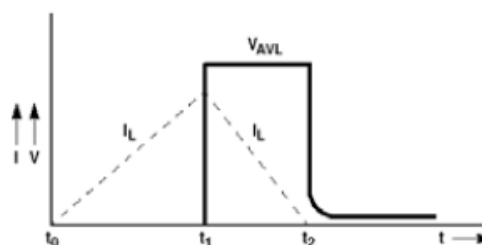

AVALANCHE CURRENT AND VOLTAGE WAVEFORMS

Typical Performance Characteristics $T_c = 25^\circ\text{C}$ unless otherwise noted

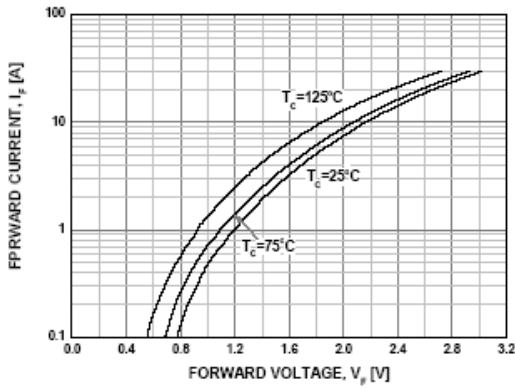

Figure 1. Typical Forward Voltage Drop

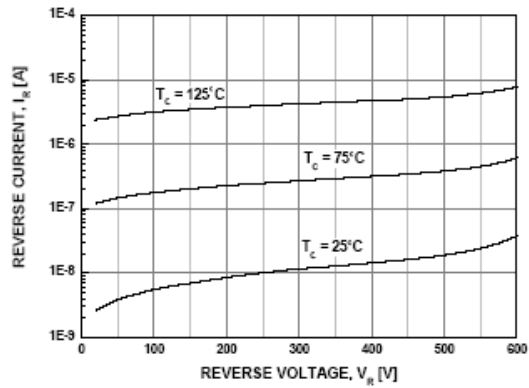

Figure 2. Typical Reverse Current

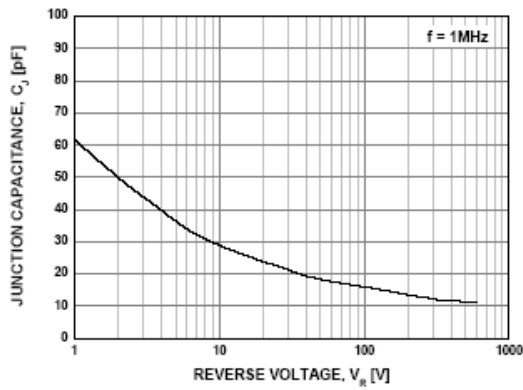

Figure 3. Typical Junction Capacitance

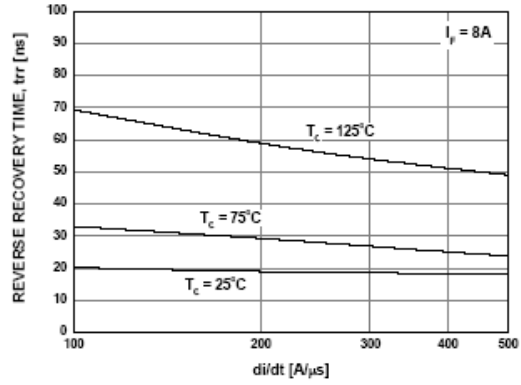

Figure 4. Typical Reverse Recovery Time

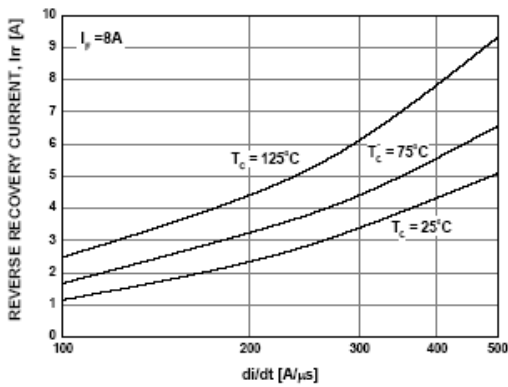

Figure 5. Typical Reverse Recovery Current

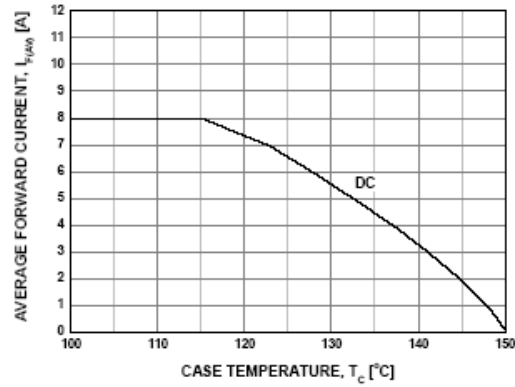
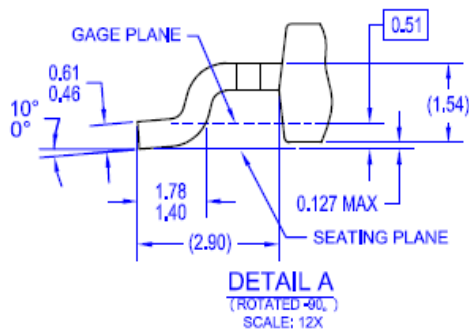
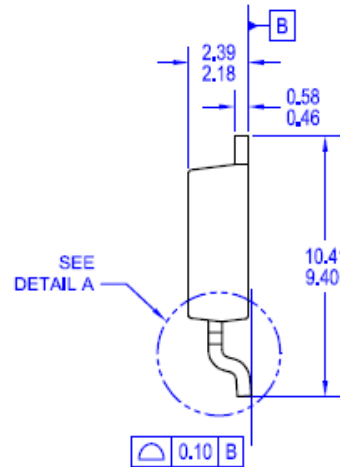
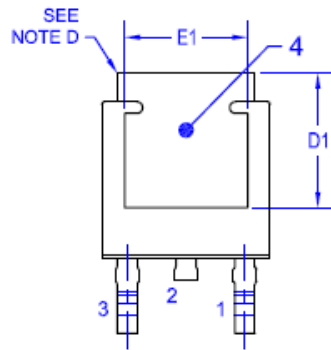
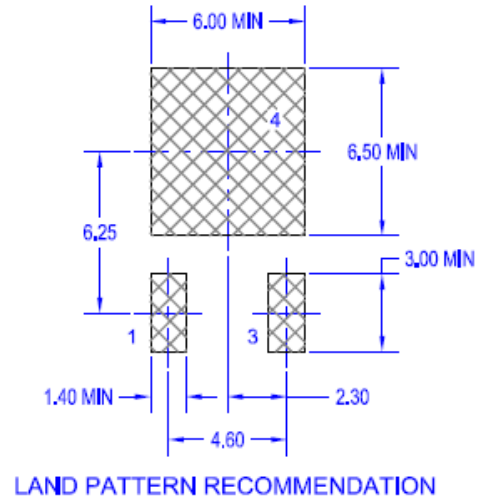
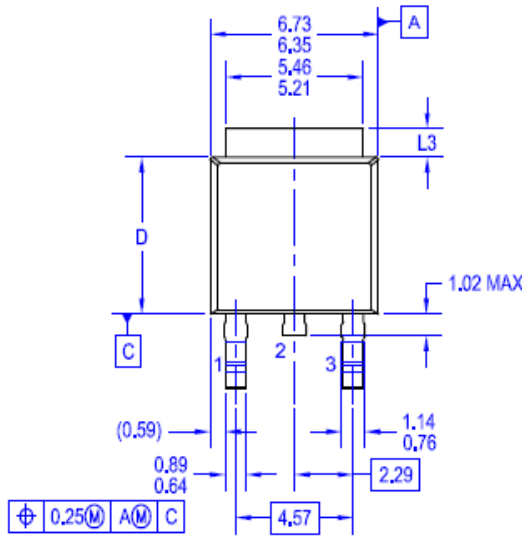

Figure 6. Forward Current Deration Curve

Mechanical Dimensions

D-PAK (TO252)



NOTES: UNLESS OTHERWISE SPECIFIED

A) PACKAGE REFERENCE: THIS PACKAGE OUTLINE CONFORMS TO JEDEC, TO-252, ISSUE C, VARIATION AA&AB, DATED NOV, 1999

B) ALL DIMENSIONS ARE IN MILLIMETERS

C) DRAWING CONFORMS TO ASME Y14.5M - 1994

D) DIMENSIONS ARE EXCLUSIVE OF BURRS, MOLD FLASH, AND TIE BAR EXTRUSIONS

E) DIMENSIONS L3, D, E1&D1 TABLE:

	OPTION AA	OPTION AB
L3	0.89-1.27	1.52-2.03
D	5.97-6.22	5.33-5.59
E1	4.32 MIN	3.81 MIN
D1	5.21 MIN	4.57 MIN





F) LAND PATTERN RECOMMENDATION IS BASED ON IPC7351A STANDARD TO228P1003x238-3N

G) DRAWING NUMBER AND REVISION: MKT-TO252A03rev06



TRADEMARKS

The following includes registered and unregistered trademarks and service marks, owned by Fairchild Semiconductor and/or its global subsidiaries, and is not intended to be an exhaustive list of all such trademarks.

AccuPower™	F-PFS™	Power-SPM™	 SYSTEM GENERAL ® The Power Franchise® the power franchise TinyBoost™ TinyBuck™ TinyCalc™ TinyLogic® TINYOPTO™ TinyPower™ TinyPWM™ TinyWire™ TriFault Detect™ TRUECURRENT™* μSerDes™  SerDes® UHC® Ultra FRFET™ UniFET™ VCX™ VisualMax™ XS™
Auto-SPM™	FRFET®	PowerTrench®	
Build it Now™	Global Power Resource SM	PowerXS™	
CorePLUS™	Green FPS™	Programmable Active Droop™	
CorePOWER™	Green FPS™ e-Series™	QFET®	
CROSSVOLT™	Gmax™	QS™	
CTL™	GTO™	Quiet Series™	
Current Transfer Logic™	IntelliMAX™	RapidConfigure™	
DEUXPEED®	ISOPLANAR™	 ™	
Dual Cool™	MegaBuck™	Saving our world, 1mW/W/kW at a time™	
EcoSPARK®	MICROCOUPLER™	SignalWise™	
EfficientMax™	MicroFET™	SmartMax™	
ESBC™	MicroPak™	SMART START™	
 ™	MicroPak2™	SPM®	
Fairchild®	MillerDrive™	STEALTH™	
Fairchild Semiconductor®	MotionMax™	SuperFET™	
FACT Quiet Series™	Motion-SPM™	SuperSOT™-3	
FACT®	OptoHiT™	SuperSOT™-6	
FAST®	OPTOLOGIC®	SuperSOT™-8	
FastvCore™	OPTOPLANAR®	SupreMOS™	
FETBench™	 ™	SyncFET™	
FlashWriter®*	PDP SPM™	Sync-Lock™	
FPS™			

* Trademarks of System General Corporation, used under license by Fairchild Semiconductor.

DISCLAIMER

FAIRCHILD SEMICONDUCTOR RESERVES THE RIGHT TO MAKE CHANGES WITHOUT FURTHER NOTICE TO ANY PRODUCTS HEREIN TO IMPROVE RELIABILITY, FUNCTION, OR DESIGN. FAIRCHILD DOES NOT ASSUME ANY LIABILITY ARISING OUT OF THE APPLICATION OR USE OF ANY PRODUCT OR CIRCUIT DESCRIBED HEREIN; NEITHER DOES IT CONVEY ANY LICENSE UNDER ITS PATENT RIGHTS, NOR THE RIGHTS OF OTHERS. THESE SPECIFICATIONS DO NOT EXPAND THE TERMS OF FAIRCHILD'S WORLDWIDE TERMS AND CONDITIONS, SPECIFICALLY THE WARRANTY THEREIN, WHICH COVERS THESE PRODUCTS.

LIFE SUPPORT POLICY

FAIRCHILD'S PRODUCTS ARE NOT AUTHORIZED FOR USE AS CRITICAL COMPONENTS IN LIFE SUPPORT DEVICES OR SYSTEMS WITHOUT THE EXPRESS WRITTEN APPROVAL OF FAIRCHILD SEMICONDUCTOR CORPORATION.

As used herein:

1. Life support devices or systems are devices or systems which, (a) are intended for surgical implant into the body or (b) support or sustain life, and (c) whose failure to perform when properly used in accordance with instructions for use provided in the labeling, can be reasonably expected to result in a significant injury of the user.
2. A critical component in any component of a life support, device, or system whose failure to perform can be reasonably expected to cause the failure of the life support device or system, or to affect its safety or effectiveness.

ANTI-COUNTERFEITING POLICY

Fairchild Semiconductor Corporation's Anti-Counterfeiting Policy. Fairchild's Anti-Counterfeiting Policy is also stated on our external website, www.fairchildsemi.com, under Sales Support.

Counterfeiting of semiconductor parts is a growing problem in the industry. All manufacturers of semiconductor products are experiencing counterfeiting of their parts. Customers who inadvertently purchase counterfeit parts experience many problems such as loss of brand reputation, substandard performance, failed applications, and increased cost of production and manufacturing delays. Fairchild is taking strong measures to protect ourselves and our customers from the proliferation of counterfeit parts. Fairchild strongly encourages customers to purchase Fairchild parts either directly from Fairchild or from Authorized Fairchild Distributors who are listed by country on our web page cited above. Products customers buy either from Fairchild directly or from Authorized Fairchild Distributors are genuine parts, have full traceability, meet Fairchild's quality standards for handling and storage and provide access to Fairchild's full range of up-to-date technical and product information. Fairchild and our Authorized Distributors will stand behind all warranties and will appropriately address any warranty issues that may arise. Fairchild will not provide any warranty coverage or other assistance for parts bought from Unauthorized Sources. Fairchild is committed to combat this global problem and encourage our customers to do their part in stopping this practice by buying direct or from authorized distributors.

PRODUCT STATUS DEFINITIONS

Definition of Terms

Datasheet Identification	Product Status	Definition
Advance Information	Formative / In Design	Datasheet contains the design specifications for product development. Specifications may change in any manner without notice.
Preliminary	First Production	Datasheet contains preliminary data; supplementary data will be published at a later date. Fairchild Semiconductor reserves the right to make changes at any time without notice to improve design.
No Identification Needed	Full Production	Datasheet contains final specifications. Fairchild Semiconductor reserves the right to make changes at any time without notice to improve the design.
Obsolete	Not In Production	Datasheet contains specifications on a product that is discontinued by Fairchild Semiconductor. The datasheet is for reference information only.

Rev. I48