

3 AMP SUPER-EFFICIENT RECTIFIERS

FEATURES

- PROPRIETARY **SOFT GLASS®** JUNCTION PASSIVATION FOR SUPERIOR RELIABILITY AND PERFORMANCE
- VOID FREE VACUUM DIE SOLDERING FOR MAXIMUM MECHANICAL STRENGTH AND HEAT DISSIPATION (Solder Voids: Typical $\leq 2\%$, Max. $\leq 10\%$ of Die Area)
- LOW SWITCHING NOISE
- LOW THERMAL RESISTANCE
- HIGH SWITCHING CAPABILITY
- LOW FORWARD VOLTAGE DROP

MECHANICAL DATA

- Case: JEDEC DO-27 molded epoxy (U/L Flammability Rating 94V-0)
- Terminals: Plated axial leads
- Solderability: Per MIL-STD 202 Method 208 guaranteed
- Polarity: Color band denotes cathode
- Mounting Position: Any
- Weight: 0.04 Ounces (1.12 Grams)

RoHS COMPLIANT

MECHANICAL SPECIFICATION

ACTUAL SIZE OF DO-27 PACKAGE

SERIES SPR30 - SPR34

DO - 27

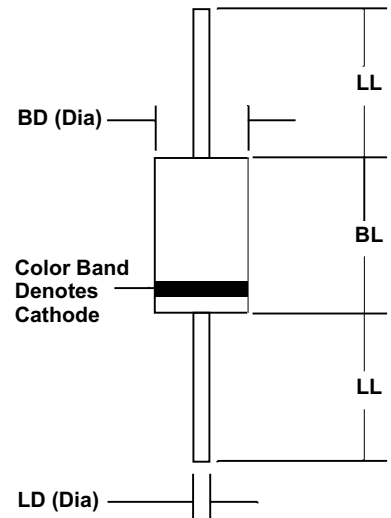
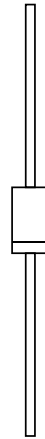

Sym	Minimum		Maximum	
	In	mm	In	mm
BL			0.365	9.28
BD			0.205	5.2
LL	1.00	25.4		
LD	0.048	1.2	0.052	1.3

MAXIMUM RATINGS & ELECTRICAL CHARACTERISTICS

Ratings at 25 °C ambient temperature unless otherwise specified.
 Single phase, half wave, 60Hz, resistive or inductive load.
 For capacitive loads, derate current by 20%.

PARAMETER (TEST CONDITIONS)	SYMBOL	RATINGS					UNITS
		SPR30	SPR31	SPR32	SPR33	SPR34	
Series Number		SPR30	SPR31	SPR32	SPR33	SPR34	
Maximum DC Blocking Voltage	V _{RM}	50	100	200	300	400	VOLTS
Maximum RMS Voltage	V _{RMS}	35	70	140	210	280	
Maximum Peak Recurrent Reverse Voltage	V _{RRM}	50	100	200	300	400	
Average Forward Rectified Current @ T _A = 55 °C	I _O	3					AMPS
Peak Forward Surge Current (8.3mS single half sine wave superimposed on rated load)	I _{FSM}	75					
Maximum Forward Voltage at 3 Amps DC	V _{FM}	1.0		1.25			VOLTS
Maximum Average DC Reverse Current At Rated DC Blocking Voltage	I _{RM}	@ T _C = 25 °C			5.0		μA
		@ T _C = 100 °C			50		
Typical Thermal Resistance, Junction to Ambient	R _{θJA}	20					°C/W
Typical Junction Capacitance (Note 1)	C _J	100					pF
Maximum Reverse Recovery Time (I _F =0.5A, I _R =1A, I _{RR} =0.25A)	T _{RR}	35					nSec
Junction Operating and Storage Temperature Range	T _J , T _{STG}	-65 to +150					°C

NOTES: (1) Measured at 1 MHz and an applied reverse voltage of 4 volts.

43716693

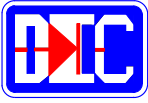

3 AMP SUPER EFFICIENT RECTIFIERS

RATING & CHARACTERISTIC CURVES FOR SERIES SPR30 - SPR34

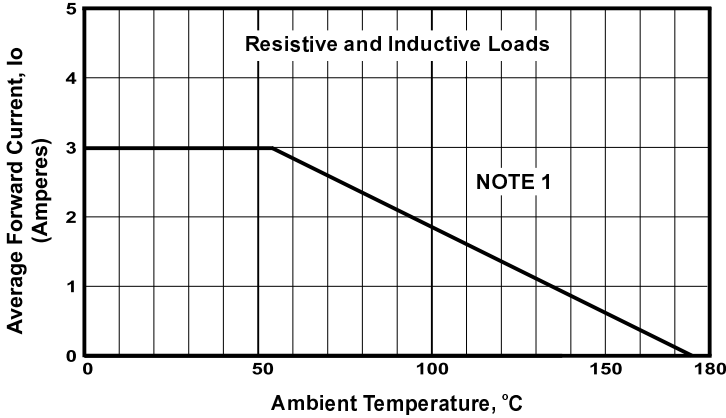

FIGURE 1. FORWARD CURRENT DERATING CURVE

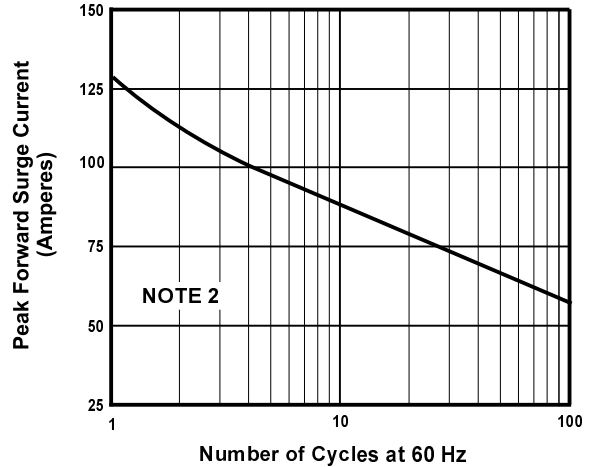

FIGURE 2. MAXIMUM NON-REPETITIVE SURGE CURRENT

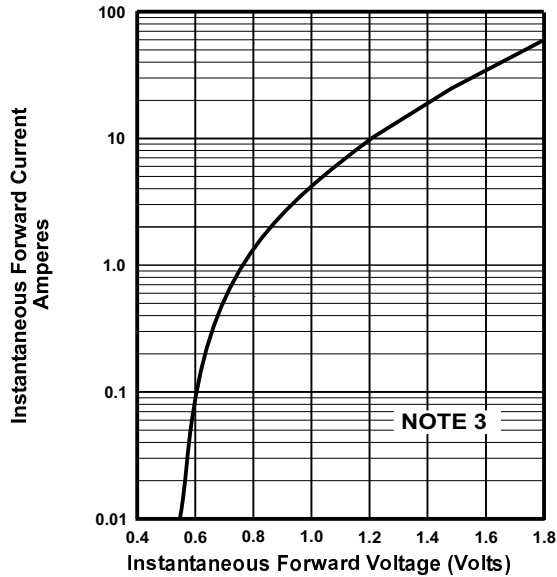

FIGURE 3. TYPICAL FORWARD CHARACTERISTICS

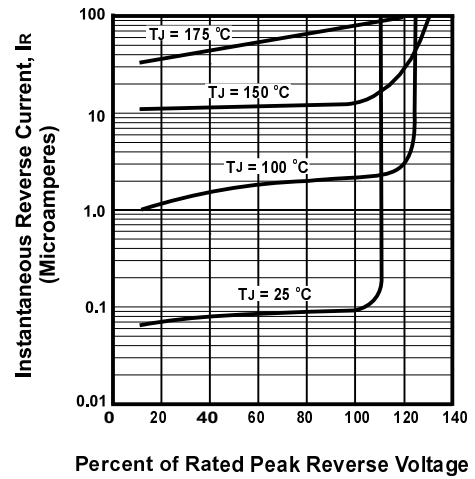

FIGURE 4. TYPICAL REVERSE CHARACTERISTICS

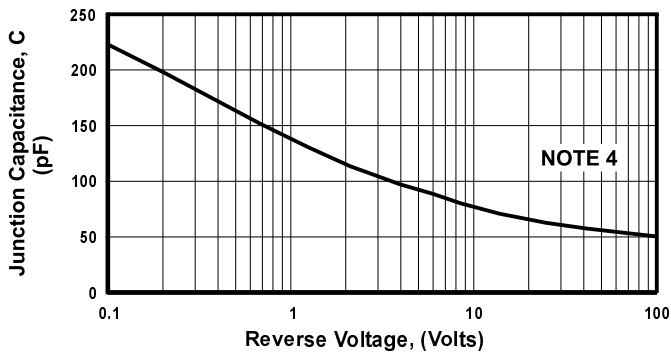

FIGURE 5. TYPICAL JUNCTION CAPACITANCE

NOTES

- (1) Single Phase, Half Wave, 60 Hz; Lead Length = 0.375" (9.5mm)
- (2) JEDEC Method, 8.3 mSec. Single Half Sine Wave; $T_A = 55^\circ\text{C}$
- (3) $T_J = 25^\circ\text{C}$, Pulse Width = 300 μSec , 1.0% Duty Cycle
- (4) $T_J = 25^\circ\text{C}$, $f = 1.0\text{ MHz}$, $V_{\text{SIG}} = 50\text{ mV P-P}$