

## 8 AMP SUPER-EFFICIENT RECTIFIERS

### FEATURES

- Glass Passivated for high reliability/temperature performance
- Low switching noise
- Low forward voltage drop
- Low thermal resistance
- High switching capability
- High surge capability

### RoHS COMPLIANT

### MECHANICAL DATA

- Case: TO-220 molded epoxy (Fully Insulated)  
(U/L Flammability Rating 94V-0)
- Terminals: Rectangular pins w/ standoff
- Solderability: Per MIL-STD 202 Method 208 guaranteed
- Polarity: Diode depicted on product
- Mounting Position: Any
- Weight: 0.06 Ounces (1.7 Grams)

### MECHANICAL SPECIFICATION

ACTUAL SIZE OF TO-220AC PACKAGE

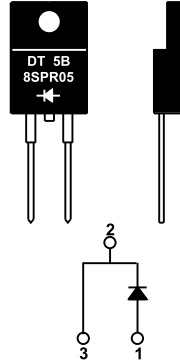

FULLY INSULATED PACKAGE

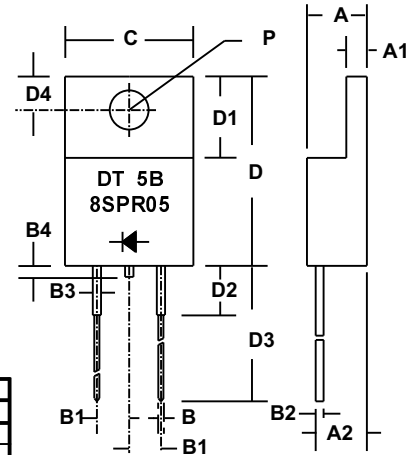

Sym	Minimum		Maximum	
	in	mm	in	mm
A			0.187	4.75
A1	0.121*	4.75*		
A2	0.14*	3.56*		
B	0.035	0.9	0.043	1.1
B1	0.09	2.3	0.102	2.6
B2	0.025*	0.64*		
B3	0.050*	1.27*		
B4			0.04	1.0
C			0.413	10.5
D	0.59	15.0	0.61	15.5
D1	0.262*	6.6*		
D2			0.16	4.0
D3	0.54	13.7	0.60	15.2
D4	0.108*	2.75*		
P	0.126*	3.2*		

\* These dimensions are "Typicals".

ITO - 220AC

SERIES 8SPR01 - 8SPR05

### MAXIMUM RATINGS & ELECTRICAL CHARACTERISTICS

Ratings at 25 °C ambient temperature unless otherwise specified.  
 Single phase, half wave, 60Hz, resistive or inductive load.  
 For capacitive loads, derate current by 20%.

PARAMETER (TEST CONDITIONS)	SYMBOL	RATINGS					UNITS
		8SPR01	8SPR02	8SPR03	8SPR04	8SPR05	
Series Number		8SPR01	8SPR02	8SPR03	8SPR04	8SPR05	
Maximum DC Blocking Voltage	V <sub>RM</sub>	100	200	300	400	500	VOLTS
Maximum RMS Voltage	V <sub>RMS</sub>	70	140	210	280	350	
Maximum Peak Recurrent Reverse Voltage	V <sub>RRM</sub>	100	200	300	400	500	
Average Forward Rectified Current @ T <sub>c</sub> = 110 °C	I <sub>O</sub>	8					AMPS
Peak Forward Surge Current ( 8.3mS single half sine wave superimposed on rated load)	I <sub>FSM</sub>	120					
Maximum Forward Voltage at 8 Amps DC	V <sub>FM</sub>	1.0		1.2			VOLTS
Maximum Average DC Reverse Current @ T <sub>c</sub> = 25 °C At Rated DC Blocking Voltage @ T <sub>c</sub> = 100 °C	I <sub>RM</sub>	10 500					μA
Typical Thermal Resistance, Junction to Case	R <sub>θJC</sub>	1.5					°C/W
Typical Junction Capacitance (Note )	C <sub>J</sub>	45					pF
Maximum Reverse Recovery Time (I <sub>F</sub> =8.0A, di/dt=50A/μS, T <sub>J</sub> =25°C)	T <sub>RR</sub>	35		45			nSec
Junction Operating and Storage Temperature Range	T <sub>J</sub> , T <sub>STG</sub>	-65 to +150					°C

NOTES: (1) Measured at 1 MHz and an applied reverse voltage of 4 volts.

43756588

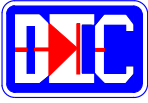

## 8 AMP SUPER EFFICIENT RECTIFIERS

### RATING & CHARACTERISTIC CURVES FOR SERIES 8SPR01 - 8SPR05

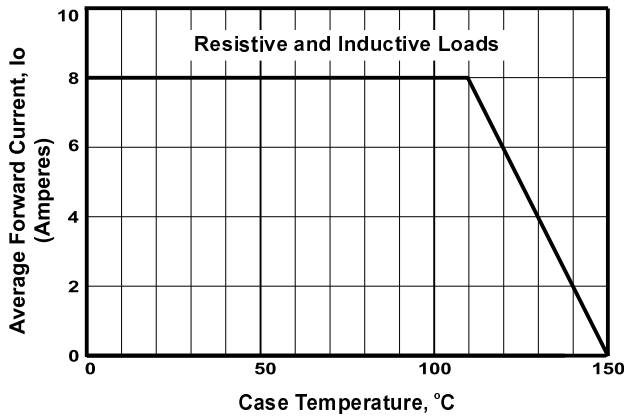

FIGURE 1. FORWARD CURRENT DERATING CURVE

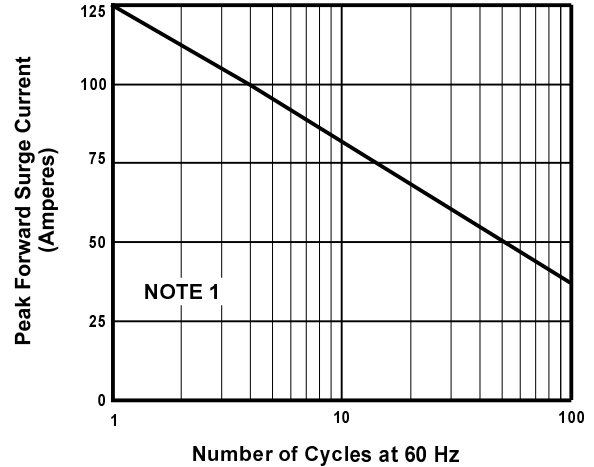

FIGURE 2. MAXIMUM NON-REPETITIVE SURGE CURRENT

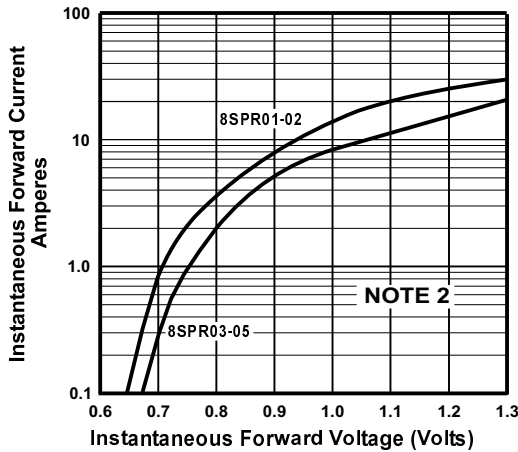

FIGURE 3. TYPICAL FORWARD CHARACTERISTICS

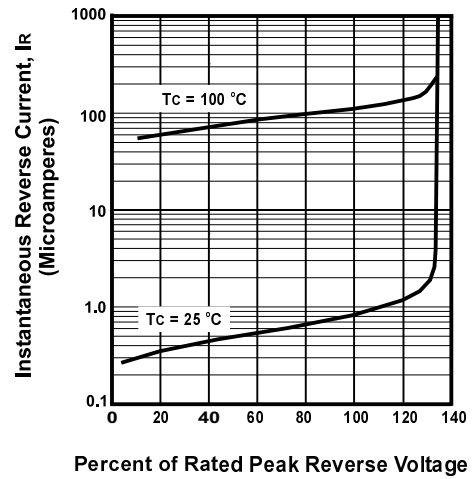

FIGURE 4. TYPICAL REVERSE CHARACTERISTICS

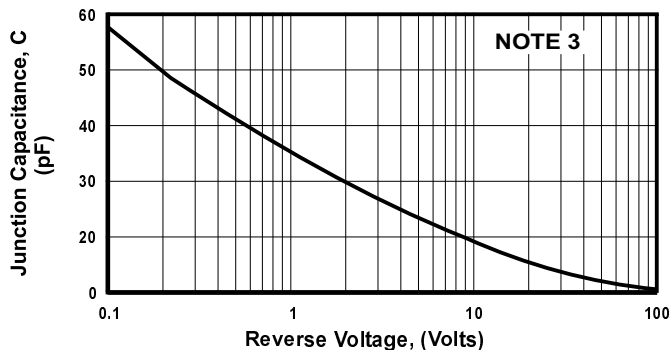

FIGURE 5. TYPICAL JUNCTION CAPACITANCE

#### NOTES

- (1) JEDEC Method, 8.3 mSec. Single Half Sine Wave
- (2)  $T_J = 25\text{ }^\circ\text{C}$ , Pulse Width = 300  $\mu\text{Sec}$ , 2.0% Duty Cycle
- (3)  $T_C = 25\text{ }^\circ\text{C}$ ,  $f = 1\text{ MHz}$ ,  $V_{SIG} = 50\text{ mV P-P}$