

SI-3000LU Series

Surface-Mount, Low Current Consumption, Low Dropout Voltage Dropper Type

■Features

- Compact surface-mount package (SOT-89-5)
- Output current: 250 mA
- Low current consumption I_q (OFF) $\leq 1\mu\text{A}$ ($V_c = 0\text{ V}$)
- Low dropout voltage: $V_{\text{DIF}} \leq 0.5\text{ V}$ (at $I_o = 250\text{ mA}$)
- 5 types of output voltages (Adj, 1.8 V, 2.5 V, 3.3 V, 5.0 V) available
- Built-in dropping type overcurrent, thermal protection circuits

■Applications

- Auxiliary power supply for PC
- Battery-driven electronic equipment

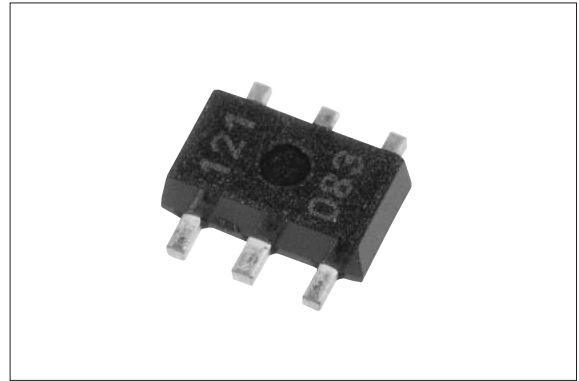

■Absolute Maximum Ratings

($T_a=25^\circ\text{C}$)

Parameter	Symbol	Ratings	Unit
DC Input Voltage	V_{IN}	18	V
DC Output Current	I_o	250	mA
Power Dissipation	P_D^{*1}	0.75	W
Junction Temperature	T_j^{*2}	-40 to +135	$^\circ\text{C}$
Storage Temperature	T_{op}^{*2}	-40 to +125	$^\circ\text{C}$
Thermal Resistance (Junction to Ambient Air)	θ_{j-a}^{*1}	146	$^\circ\text{C/W}$

*1: When mounted on glass-epoxy board $40 \times 40\text{ mm}$ (copper laminate area 2%)

*2: Thermal protection circuits may operate if the junction temperature exceeds 135°C

■Recommended Operating Conditions

Parameter	Symbol	Ratings		Unit
		min.	max.	
Input Voltage	V_{IN}	*2, *3	V_o+2^{*1}	V
DC Output Current	I_o	0	250	mA
Ambient Operating Temperature	T_{op}	-20	85	$^\circ\text{C}$

*1: V_{IN} (max) and I_o (max) are restricted by the relationship $P_D = (V_{\text{IN}} - V_o) \times I_o$.

Calculate these values referring to the reference data.

*2: Refer to the dropout voltage section.

*3: For the SI-3012LU, set the input voltage to at least 2.4 V, and secure the minimum voltage as explained in Setting DC Input Voltage, Dropper Type Application Note.

Electrical Characteristics

(Ta=25°C, Vc=2V unless otherwise specified)

Parameter	Symbol	Ratings															Unit
		SI-3012LU			SI-3018LU (Under development)			SI-3025LU (Under development)			SI-3033LU			SI-3050LU (Under development)			
		min.	typ.	max.	min.	typ.	max.	min.	typ.	max.	min.	typ.	max.	min.	typ.	max.	
Output Voltage	Vo	1.210	1.250	1.290	1.764	1.800	1.836	2.450	2.500	2.550	3.234	3.300	3.366	4.900	5.000	5.100	V
	Conditions	VIN=Vo+1V, Io=10mA			VIN=3.3V, Io=10mA			VIN=3.3V, Io=10mA			VIN=5V, Io=10mA			VIN=6V, Io=10mA			
Dropout Voltage	V _{DIF}			0.3			0.5			0.3			0.3			0.3	V
	Conditions	Io=100mA(Vo=3.3V)			Io=100mA												
	Conditions	Io=250mA(Vo=3.3V)			Io=250mA												
Line Regulation	ΔV _{LINE}			10			10			10			10			15	mV
	Conditions	VIN=Vo+1 to Vo+5V, Io=10mA(Vo=3.3V)			VIN=2.5 to 5V, Io=10mA			VIN=3.3 to 5V, Io=10mA			VIN=4.5 to 8V, Io=10mA			VIN=6 to 10V, Io=10mA			
Load Regulation	ΔV _{LOAD}			20			20			40			40			40	mV
	Conditions	VIN=Vo+1V, Io=1 to 250mA(Vo=3.3V)			VIN=3.3V, Io=1 to 250mA			VIN=3.3V, Io=0 to 250mA			VIN=5V, Io=0 to 250mA			VIN=6V, Io=0 to 250mA			
Temperature Coefficient of Output Voltage	ΔVo/ΔTa			±0.3			±0.2			±0.25			±0.3			±0.3	mV/°C
	Conditions	Tj=0 to 100°C															
Ripple Rejection	R _{REJ}			55			55			55			55			55	dB
	Conditions	VIN=Vo+1V, f=100 to 120Hz(Vo=3.3V)			VIN=3.3V, f=100 to 120Hz			VIN=3.3V, f=100 to 120Hz			VIN=5V, f=100 to 120Hz			VIN=6V, f=100 to 120Hz			
Quiescent Circuit Current	I _q			150			150			150			150			150	μA
	Conditions	VIN=Vo+1V, Io=0mA, Vc=2V, R2=100kΩ			VIN=3.3V, Io=0mA, Vc=2V			VIN=3.3V, Io=0mA, Vc=2V			VIN=5V, Io=0mA, Vc=2V			VIN=6V, Io=0mA, Vc=2V			
OFF Circuit Current	I _{q(OFF)}			1			1			1			1			1	μA
	Conditions	VIN=Vo+1V, Vc=0V			VIN=3.3V, Vc=0V			VIN=3.3V, Vc=0V			VIN=5V, Vc=0V			VIN=6V, Vc=0V			
Overcurrent Protection Starting Current ^{*1}	Is1	260			260			260			260			260			mA
	Conditions	VIN=Vo+1V			VIN=3.3V			VIN=3.3V			VIN=5V			VIN=6V			
Vc Pin	Control Voltage (Output ON) ^{*2}	Vc, IH	2.0			2.0			2.0			2.0			2.0		V
	Control Voltage (Output OFF) ^{*2}	Vc, IL			0.8			0.8			0.8			0.8			
	Control Current (Output ON)	Ic, IH			40			40			40			40			μA
	Conditions	Vc=2V															
Control Current (Output OFF)	Ic, IL		0	-5		0	-5		0	-5		0	-5		0	-5	μA
	Conditions	Vc=0V															
Output OFF Voltage	Vo			0.5			0.5			0.5			0.5			0.5	V

*1: Is1 is specified as the 5% drop point of output voltage Vo on the condition that VIN = 3.3 V (5 V for SI-3033LU, 6 V for SI-3050LU), and Io = 10 mA.

*2: Output is OFF when the output control pin (Vc pin) is open. Each input level is equivalent to that for LS-TTL. Therefore, the device can be driven directly by an LS-TTL circuit.

External Dimensions

(Unit : mm)

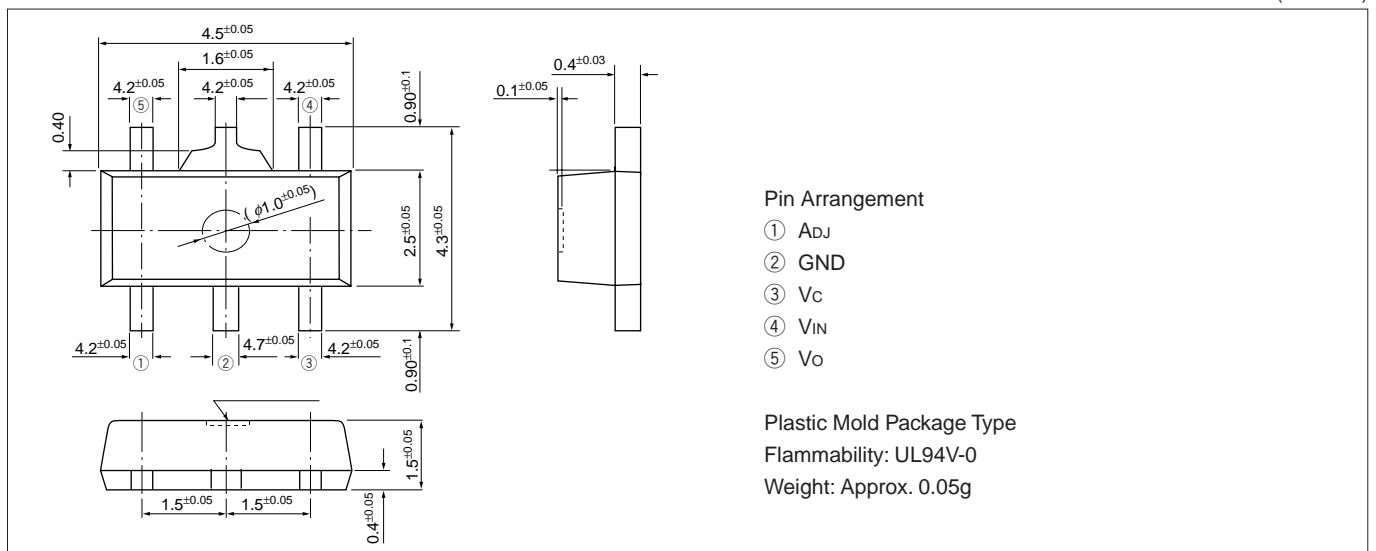

■Block Diagram

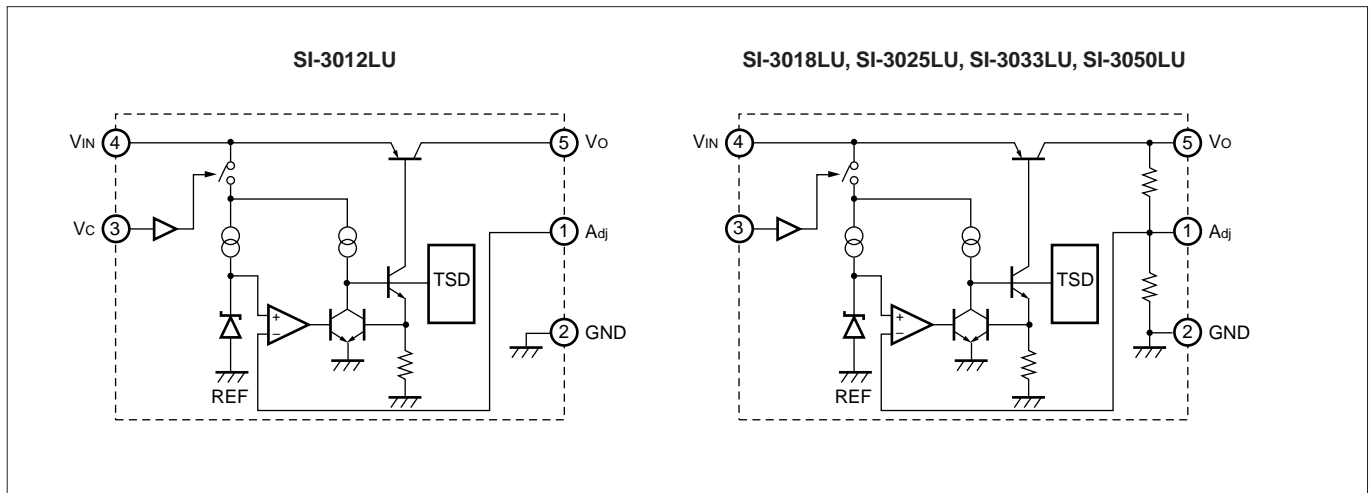

■Standard External Circuit

SI-3018LU, SI-3025LU, SI-3033LU, SI-3050LU

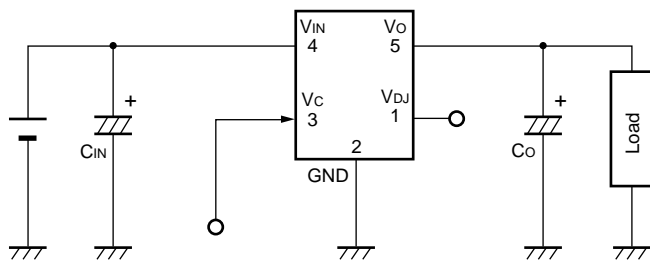

Co : Output capacitor (10 μ F or larger)

The SI-3000LU series can be operated on the circuit even if a low ESR ceramic capacitor is used as the output capacitor.

CIN : Input capacitor (0.1 to 10 μ F)

This capacitor is required in the case of an inductive input line or long wiring.

●Settings for SI-3012LU output voltage (recommended voltage: 1.5 V to 15 V)

R1 and R2: Resistors for output setting

The output voltage can be set by connecting R1 and R2 as shown in the diagram on the left.

R2: 100 k Ω is recommended

$$R1 = (V_O - V_{ADJ}) / (V_{ADJ} / R2)$$

SI-3012LU

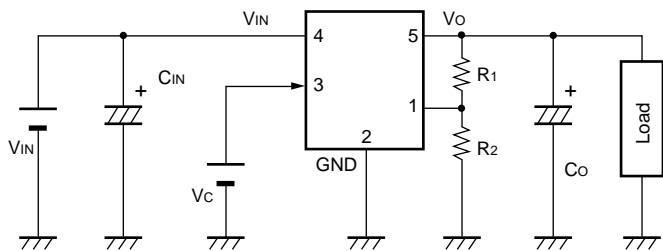

■Reference Data

Copper Laminate Area vs Power Dissipation
T_j=100°C PWB size 40×40

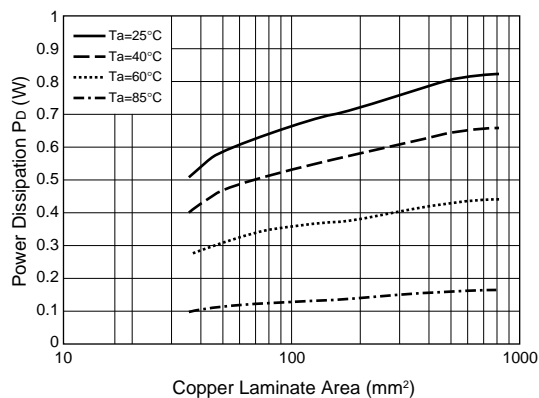

- A monolithic IC is mounted. The inner frame stage is connected to the GND pin (pin 2). Therefore, enlarging the copper laminate area leading to the GND pin achieves a heat radiation effect.

- How to calculate the junction temperature
Measure the temperature (T_c) of the GND pin (pin 2) lead section using a thermistor, etc. Substitute this value in the following formula and calculate the junction temperature.

$$T_j = P_D \times \theta_{j-c} + T_c \quad (\theta_{j-c} = 5^\circ\text{C/W})$$

■Typical Characteristics of SI-3033LU

($T_a=25^\circ\text{C}$)

I_o vs. V_{DIF} Characteristics

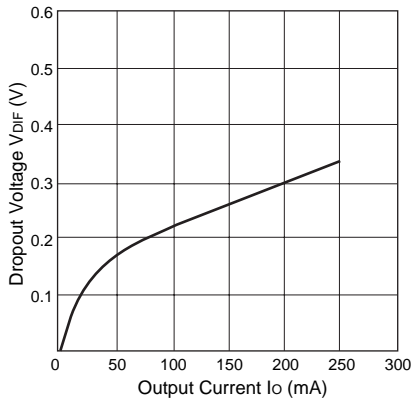

Output Voltage Characteristics

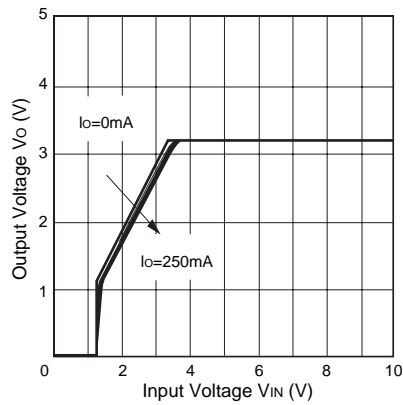

Line Regulation

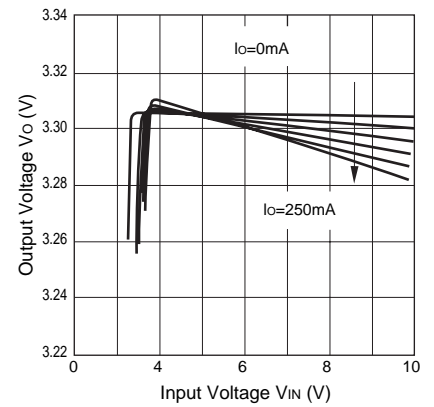

Load Regulation

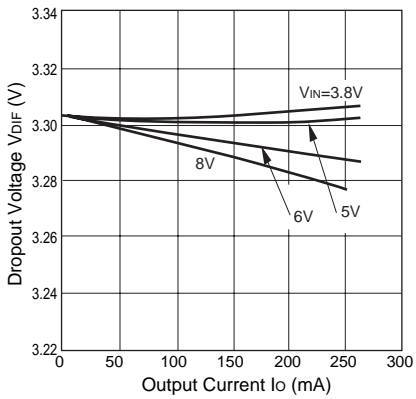

Output ON/OFF Control

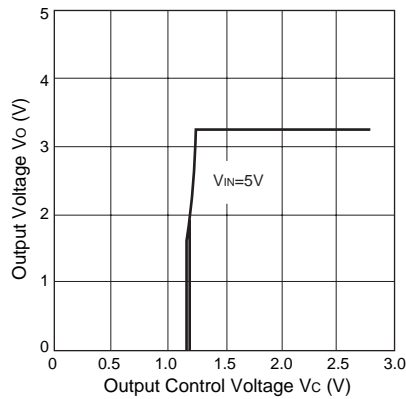

Overcurrent Protection Characteristics

