



## UT70P03

Power MOSFET

### 75A, 30V P-CHANNEL POWER MOSFET

#### DESCRIPTION

The **UT70P03** uses advanced trench technology to provide excellent  $R_{DS(ON)}$ , low gate charge and operation with low gate voltages. This device is suitable for use as a load switch or in PWM applications.

#### FEATURES

- \*  $R_{DS(ON)} = 8m\Omega @ V_{GS} = -10V$
- \* Low Capacitance
- \* Low Gate Charge
- \* Fast Switching Capability
- \* Avalanche Energy Specified

#### SYMBOL

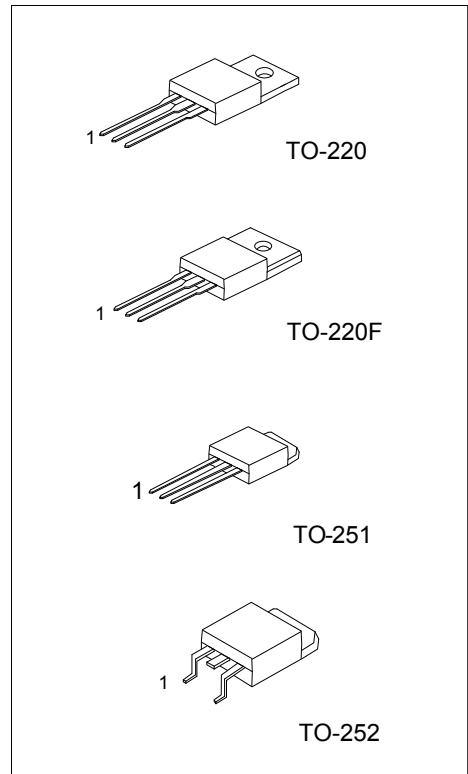
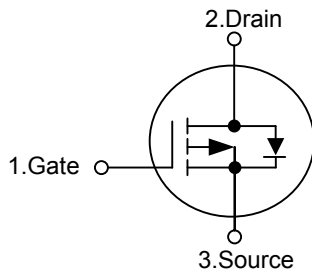

#### ORDERING INFORMATION

Ordering Number		Package	Pin Assignment			Packing
Lead Free	Halogen Free		1	2	3	
UT70P03L-TA3-T	UT70P03G-TA3-T	TO-220	G	D	S	Tube
UT70P03L-TF3-T	UT70P03G-TF3-T	TO-220F	G	D	S	Tube
UT70P03L-TM3-T	UT70P03G-TM3-T	TO-251	G	D	S	Tube
UT70P03L-TN3-R	UT70P03G-TN3-R	TO-252	G	D	S	Tape Reel

<p>UT70P03L-TA3-T</p>	<p>(1) R: Tape Reel, T: Tube</p> <p>(2) TA3: TO-220, TF3: TO-220F, TM3: TO-251, TN3: TO-252</p> <p>(3) G: Halogen Free, L: Lead Free</p>
-----------------------	--

### ■ ABSOLUTE MAXIMUM RATINGS ( $T_A=25^{\circ}\text{C}$ unless otherwise specified)

PARAMETER		SYMBOL	RATINGS	UNIT
Drain-Source Voltage		$V_{DSS}$	-30	V
Gate-Source Voltage		$V_{GSS}$	$\pm 20$	V
Continuous Drain Current, $V_{GS}=4.5\text{V}$	$T_C=25^{\circ}\text{C}$	$I_D$	-75	A
Pulsed Drain Current(Note 2)		$I_{DM}$	-350	A
Power Dissipation ( $T_C=25^{\circ}\text{C}$ )	TO-220	$P_D$	147	W
	TO-220F		37	
	TO-251/ TO-252		107	
Junction Temperature		$T_J$	+175	$^{\circ}\text{C}$
Strong Temperature		$T_{STG}$	-55 ~ +175	$^{\circ}\text{C}$

Note: 1. Absolute maximum ratings are those values beyond which the device could be permanently damaged.

Absolute maximum ratings are stress ratings only and functional device operation is not implied.

2. Pulse width limited by safe operating area.

### ■ THERMAL DATA

PARAMETER		SYMBOL	RATING	UNIT
Junction to Ambient	TO-220/TO-220F	$\theta_{JA}$	62.5	$^{\circ}\text{C/W}$
	TO-251/ TO-252		110	
Junction to Case	TO-220	$\theta_{JC}$	0.85	$^{\circ}\text{C/W}$
	TO-220F		3.4	
	TO-251/ TO-252		1.4	

### ■ ELECTRICAL CHARACTERISTICS ( $T_J=25^{\circ}\text{C}$ , unless otherwise specified)

PARAMETER	SYMBOL	TEST CONDITIONS	MIN	TYP	MAX	UNIT
<b>OFF CHARACTERISTICS</b>						
Drain-Source Breakdown Voltage	$BV_{DSS}$	$V_{GS}=0\text{V}, I_D=-250\mu\text{A}$	-30			V
Breakdown Voltage Temperature Coefficient	$\frac{\Delta BV_{DSS}}{\Delta T_J}$	Reference to $25^{\circ}\text{C}, I_D=-1\text{mA}$		-0.018		$\text{V}/^{\circ}\text{C}$
Drain-Source Leakage Current	$I_{DSS}$	$V_{DS}=-30\text{V}, V_{GS}=0\text{V}, T_J=25^{\circ}\text{C}$			-1	$\mu\text{A}$
Gate-Body Leakage Current	$I_{GSS}$	$V_{GS}=\pm 20\text{V}$			$\pm 100$	nA
<b>ON CHARACTERISTICS</b>						
Gate Threshold Voltage	$V_{GS(TH)}$	$V_{DS}=V_{GS}, I_D=-250\mu\text{A}$	-1		-3	V
Static Drain-Source On-Resistance (Note 2)	$R_{DS(ON)}$	$V_{GS}=-10\text{V}, I_D=-45\text{A}$			8	$\text{m}\Omega$
		$V_{GS}=-4.5\text{V}, I_D=-30\text{A}$			10	$\text{m}\Omega$
<b>DYNAMIC PARAMETERS</b>						
Input Capacitance	$C_{ISS}$	$V_{DS}=-25\text{V}, V_{GS}=0\text{V}, f=1.0\text{MHz}$		2700	4200	pF
Output Capacitance	$C_{OSS}$			550		pF
Reverse Transfer Capacitance	$C_{RSS}$			380		pF
<b>SWITCHING PARAMETERS</b>						
Total Gate Charge(Note 2)	$Q_G$	$V_{DS}=-24\text{V}, V_{GS}=-4.5\text{V}, I_D=-30\text{A}$		33	52	nC
Gate Source Charge	$Q_{GS}$			7.5		nC
Gate Drain ("Miller") Charge	$Q_{GD}$			24		nC
Turn-ON Delay Time(Note 2)	$t_{D(ON)}$	$V_{GS}=-10\text{V}, V_{DS}=-15\text{V}, R_D=0.5\Omega, I_D=-30\text{A}, R_G=3.3\Omega$		11.2		ns
Turn-ON Rise Time	$t_R$			77		ns
Turn-OFF Delay Time	$t_{D(OFF)}$			35		ns
Turn-OFF Fall-Time	$t_F$			67		ns
<b>SOURCE- DRAIN DIODE RATINGS AND CHARACTERISTICS</b>						
Forward On Voltage(Note 2)	$V_{SD}$	$I_S=-45\text{A}, V_{GS}=0\text{V}$			-1.3	V
Reverse Recovery Time	$t_{RR}$	$I_S=-30\text{A}, V_{GS}=0\text{V},$		28		ns
Reverse Recovery Charge	$Q_{RR}$	$dI/dt=100\text{A}/\mu\text{s}$		10		nC

Notes: 1. Pulse width  $\leq 300\mu\text{s}$ , duty cycle  $\leq 2\%$ .

## TYPICAL CHARACTERISTICS

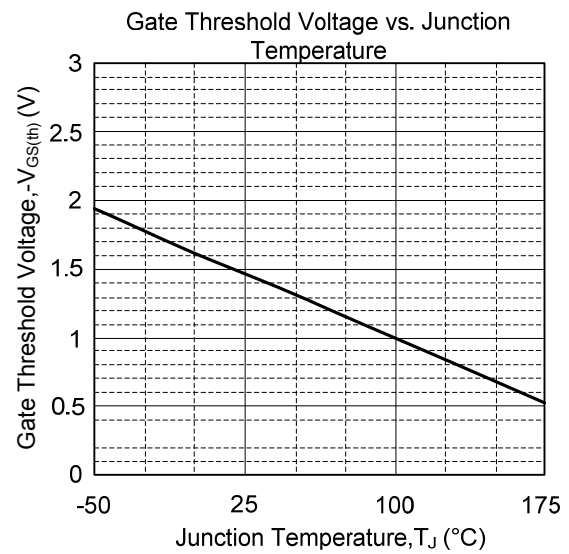
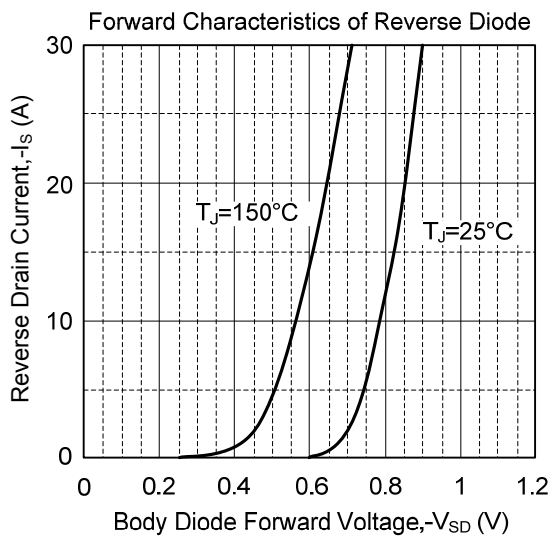
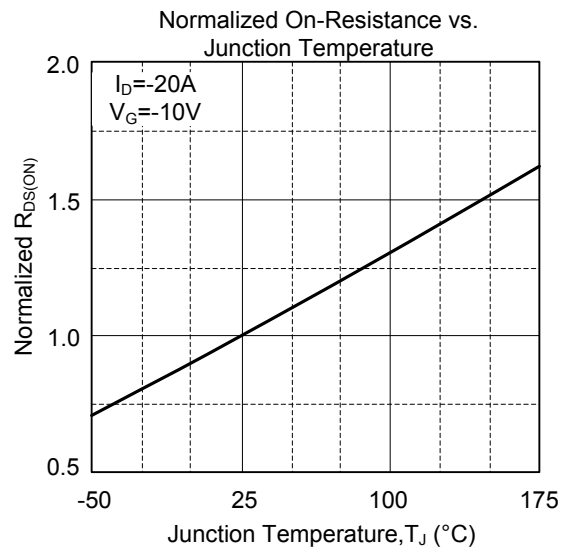
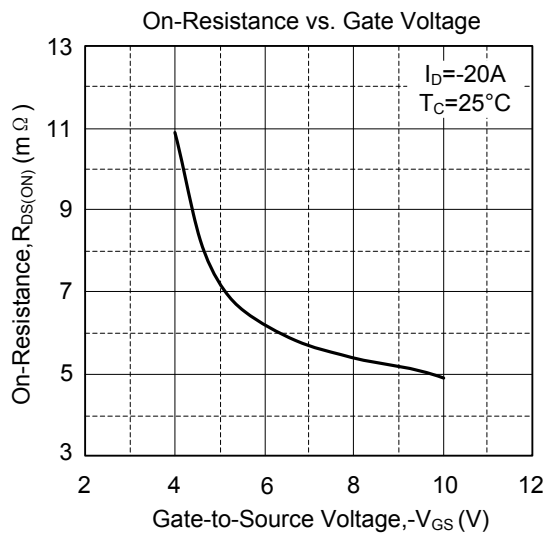
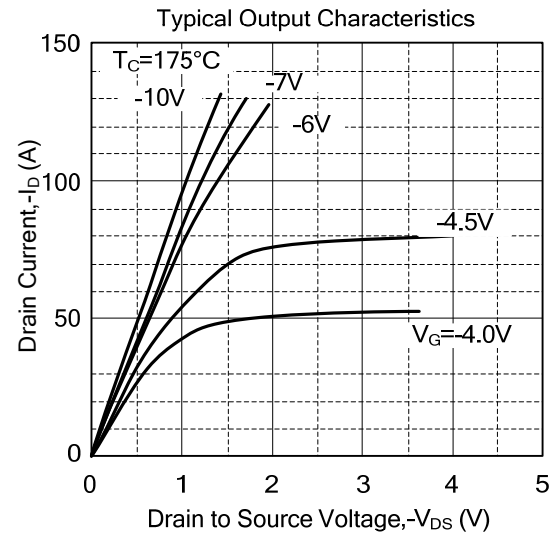
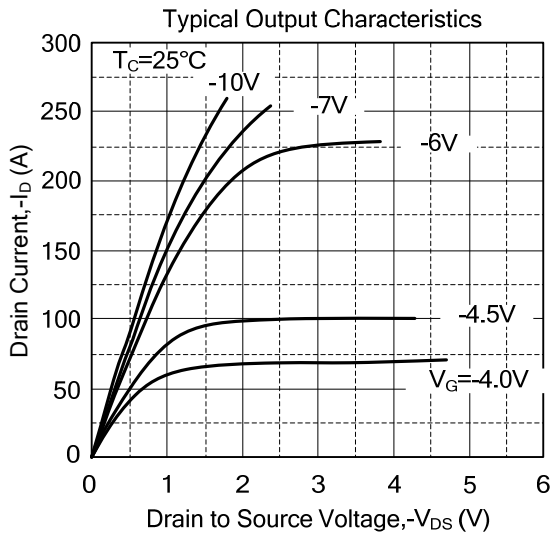

■ TYPICAL CHARACTERISTICS(Cont.)

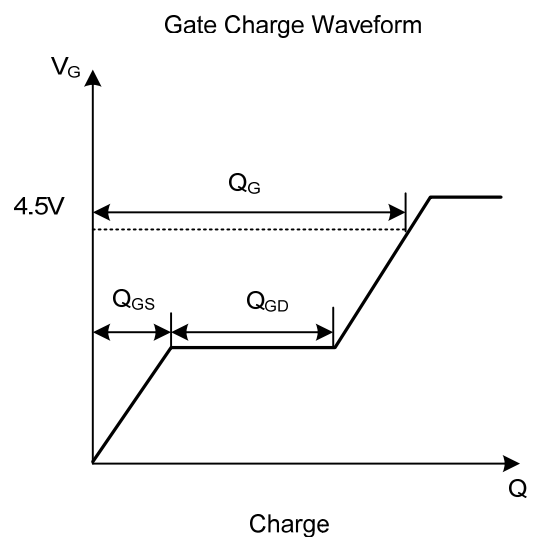
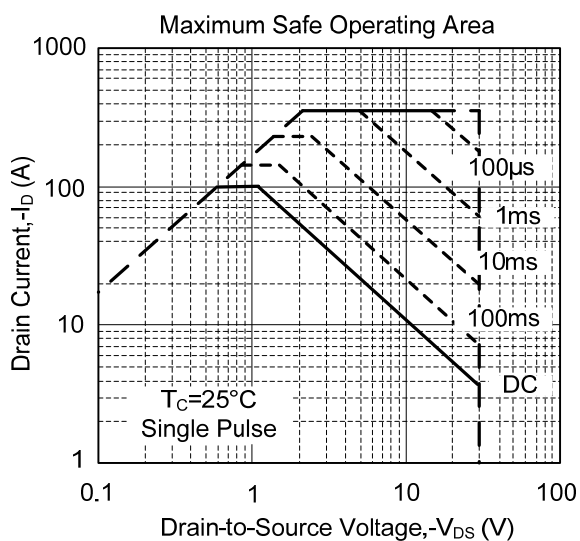
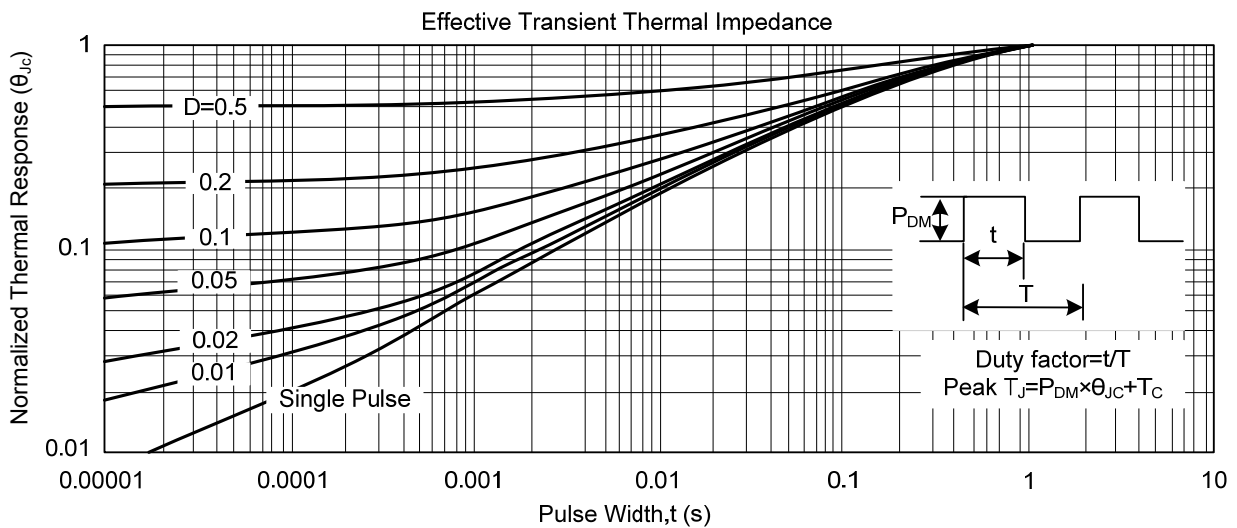
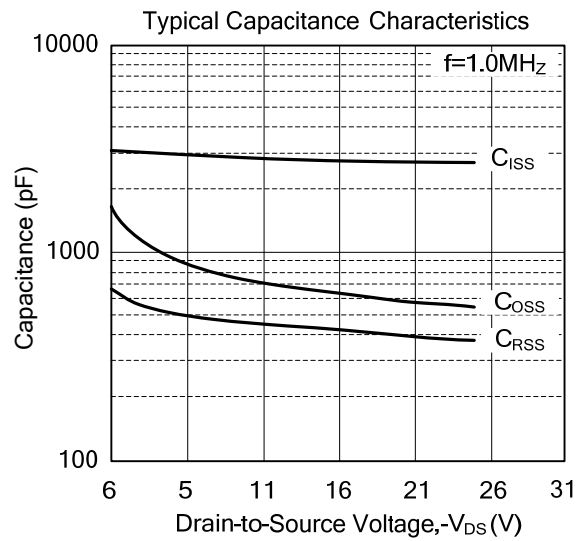
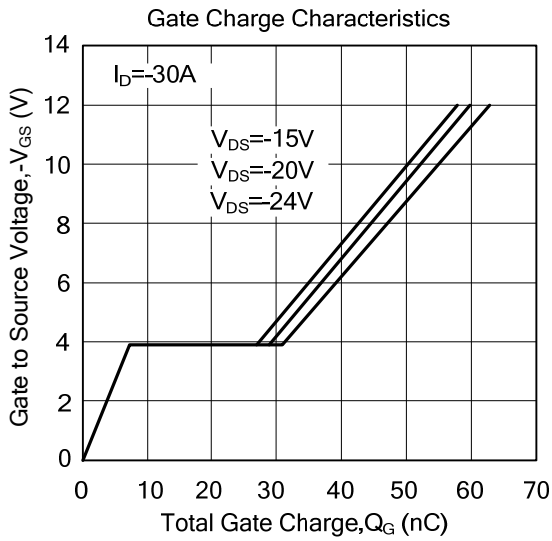

UTC assumes no responsibility for equipment failures that result from using products at values that exceed, even momentarily, rated values (such as maximum ratings, operating condition ranges, or other parameters) listed in products specifications of any and all UTC products described or contained herein. UTC products are not designed for use in life support appliances, devices or systems where malfunction of these products can be reasonably expected to result in personal injury. Reproduction in whole or in part is prohibited without the prior written consent of the copyright owner. The information presented in this document does not form part of any quotation or contract, is believed to be accurate and reliable and may be changed without notice.