

## FEATURES

- ◆ Wide (2:1) input range
- ◆ Operating temperature: -40°C ~ +85 °C
- ◆ 1500VDC isolation
- ◆ No heat sink required
- ◆ Internal SMD construction
- ◆ MTBF>1,000,000 hours
- ◆ Short circuit protection(Automatic recovery)
- ◆ Industry standard pinout
- ◆ RoHS Compliance

## MODEL SELECTION

**WRB<sup>①</sup> 24<sup>②</sup> 12<sup>③</sup> Y<sup>④</sup> MT<sup>⑤</sup> -2W<sup>⑥</sup>**

- ① Product Series      ② Input Voltage  
 ③ Output Voltage    ④ Wide (2:1) Input Range  
 ⑤ Mini package style   ⑥ Rated Power

## DESCRIPTION

The WRA\_YMT-2W & WRB\_YMT-2W Series are specially designed for applications where a wide range input voltage power supplies are isolated from the input power supply in a distributed power supply system on a circuit board.

These products apply to:

- 1) Where the voltage of the input power supply is wide range (voltage range ≤2:1);
- 2) Where isolation is necessary between input and output (Isolation Voltage ≤1500VDC);
- 3) Where the regulation of the output voltage and the output ripple noise are demanded.



**CE REACH**  
 MICRODC reserves the copyright

## SELECTION GUIDE

order code	Input			Output			Efficiency (% Typ.)
	Voltage(VDC)			Voltage (VDC)	Current(MA)		
	Nominal	Range	Max*		Max.	Min.	
WRA1205YMT-2W	12	9-18	22	±5	±200	±20	74
WRA1212YMT-2W	12	9-18	22	±12	±83	±8	78
WRA1215YMT-2W	12	9-18	22	±15	±67	±7	78
WRB1203YMT-1W6	12	9-18	22	3.3	500	50	70
WRB1205YMT-2W	12	9-18	22	5	400	40	74
WRB1209YMT-2W	12	9-18	22	9	222	22	76
WRB1212YMT-2W	12	9-18	22	12	167	16	78
WRB1215YMT-2W	12	9-18	22	15	133	13	79
WRA2405YMT-2W	24	18-36	40	±5	±200	±20	74
WRA2412YMT-2W	24	18-36	40	±12	±83	±8	78
WRA2415YMT-2W	24	18-36	40	±15	±67	±7	78
WRB2403YMT-1W6	24	18-36	40	3.3	500	50	72
WRB2405YMT-2W	24	18-36	40	5	400	40	76
WRB2409YMT-2W	24	18-36	40	9	222	22	78
WRB2412YMT-2W	24	18-36	40	12	167	16	80
WRB2415YMT-2W	24	18-36	40	15	133	13	80

\*Input voltage can't exceed this value, or will cause the permanent damage.

## COMMON SPECIFICATIONS

Item	Test conditions	Min.	Typ.	Max.	Units
Storage humidity range				95	%
Operating temperature		-40		85	°C
Storage temperature		-55		125	°C
Temp. rise at full load			15		°C
Lead temperature	1.5mm from case for 10 seconds			300	°C
Short circuit protection		Continuous, automatic recovery			
Cooling		Free air convection			
Package material		Epoxy Resin (UL94-V0)			
MTBF		1000			K hours
Weight			5.2		g

### ISOLATION SPECIFICATIONS

Item	Test Conditions	Min.	Typ.	Max.	Units
Isolation voltage	Tested for 1 minute and 1mA max.	1500			VDC
Isolation resistance	Test at 500VDC	1000			MΩ
Isolation capacitance	Input/Output, 100KHz/1V		85		pF

\*Supply voltage must be discontinued at the end of short circuit duration.

### OUTPUT SPECIFICATIONS

Item	Test Conditions	Min.	Typ.	Max.	Units
Output power	See above products program	0.2		2	W
Positive voltage accuracy	Refer to recommended circuit		±1	±3	%
Negative voltage accuracy	Refer to recommended circuit		±3	±5	%
Load regulation	From 10% to 100% load		±0.5	±1*	%
Line regulation	Input voltage from low to high		±0.2	±0.5	%
Temperature Drift (Vout)	Refer to recommended circuit			±0.03	%/°C
Output ripple & noise**	20MHz Bandwidth		35	150	mVp-p
Switching frequency	100% load, nominal input voltage		300		KHz

\*Dual output models unbalanced load: ±5%.

\*\*Test ripple and noise by "Parallel cable" method. See detailed operation instructions at Testing of Power Converter section, application notes.

### TYPICAL CHARACTERISTICS

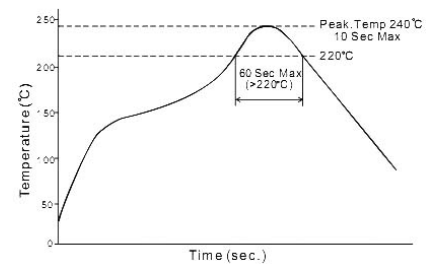
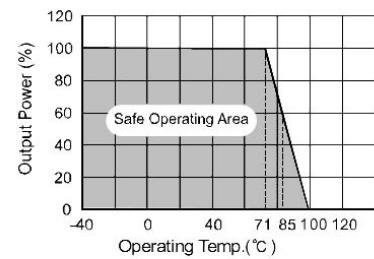

### APPLICATION NOTE

#### Requirement On Output Load

In order to ensure the product operate efficiently and reliably, in addition to a max load (namely full load), a minimum load is specified for this kind of DC/DC converter. Make sure the specified range of input voltage is not exceeded, the minimum output load no less than 10% load. If the actual load is less than the specified minimum load, the output ripple may increase sharply while its efficiency and reliability will reduce greatly. If the actual output power is very small, please add an appropriate resistor as extra loading, or contact our company for other lower output power products.

#### Recommended Circuit

All the WRA\_YMT-2W & WRB\_YMT-2W Series have been tested according to the following recommended testing circuit before leaving factory. This series should be tested under load. (See Figure 1).

If you want to further decrease the input/output ripple, you can increase capacitance properly or choose capacitors with low ESR. However, the capacitance of the output filter capacitor must be proper. If the capacitance is too big, a startup problem might arise. For every channel of output, provided the safe and reliable operation is ensured, the greatest capacitance of its filter capacitor sees (Table 1).

General: Cin: 12V 100μF  
 24V&48V 10μF-47μF  
 Cout: 10μF/100mA

#### Input Current

When it is used in unregulated power supply, be sure that the fluctuating range of the power supply and the rippled voltage do not exceed the module standard. Input current of power supply should afford the flash startup current of this kind of DC/DC module. (Figure 2)

General:  $I_p \leq 1.4 \cdot I_{in-max}$

#### No parallel connection or plug and play

### RECOMMENDED CIRCUIT

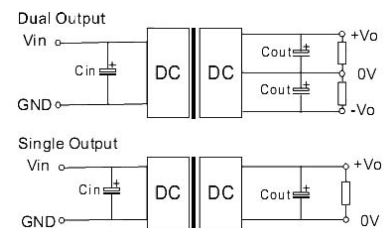

(Figure 1)

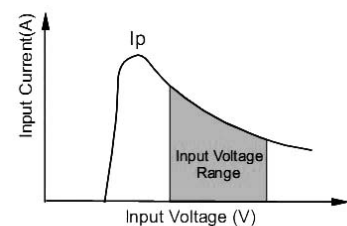

(Figure 2)

### Output External Capacitor Table (Table 1)

Single Vout (VDC)	Cout (μF)	Dual Vout (VDC)	Cout (μF)
3.3	2200	±5	680
5	1000	±9	470
9	680	±12	330
12	470	±15	220
15	330	-	-

### OUTLINE DIMENSIONS & PIN CONNECTIONS

#### MECHANICAL DIMENSIONS

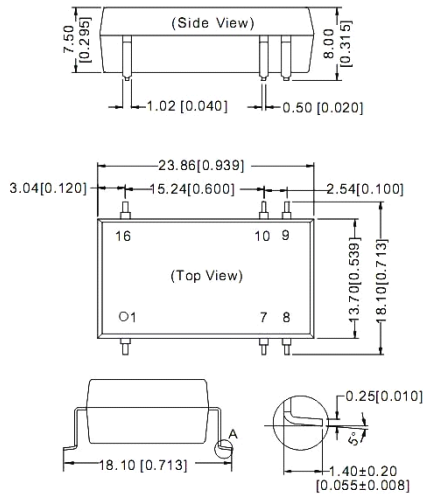

Note:

Unit:mm[ inch]

Pin section tolerances:  $\pm 0.10\text{mm}[\pm 0.004\text{inch}]$

General tolerances:  $\pm 0.25\text{mm}[\pm 0.010\text{inch}]$

#### FOOTPRINT DETAILS

Pin	Single	Dual
1	GND	GND
7	NC	NC
8	NC	0V
9	+Vo	+Vo
10	0V	-Vo
16	Vin	Vin

NC: No connection

#### RECOMMENDED FOOTPRINT(TOP VIEW)

DUAL/SINGLE OUTPUT

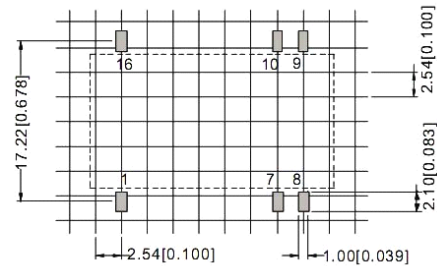

#### TUBE OUTLINE DIMENSIONS

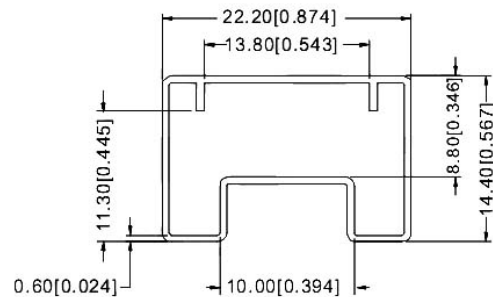

Note:

Unit :mm[inch]

General tolerances:  $\pm 0.50\text{mm}[\pm 0.020\text{inch}]$

L=530mm[20.866inch] Tube Quantity: 21pcs

L=220mm[8.661inch] Tube Quantity: 8pcs

Note:

- The load shouldn't be less than 10%, otherwise ripple will increase dramatically.
- Operation under 10% load will not damage the converter; However, they may not meet all specification listed.
- Capacitor MAX load tested at input voltage range and full load.
- All specifications measured at  $T_a=25^\circ\text{C}$ , humidity<75%, nominal input voltage and rated output load unless otherwise specified.
- In this datasheet, all the test methods of indications are based on corporate standards.
- Only typical models listed, other models may be different, please contact our technical person for more details.

#### RoHS COMPLIANT INFORMATION

This series is compatible with RoHS soldering systems with a peak wave solder temperature of  $300^\circ\text{C}$  for 10 seconds.

The pin termination finish on the SIP package type is Tin Plate, Hot Dipped over Matte Tin with Nickel Preplate. The DIP types are Matte Tin over Nickel Preplate. Both types in this series are backward compatible with Sn/Pb soldering systems.

#### REACH COMPLIANT INFORMATION

This series has proven that this product does not contain harmful chemicals, it also has harmful chemical substances through the registration, inspection and approval.