

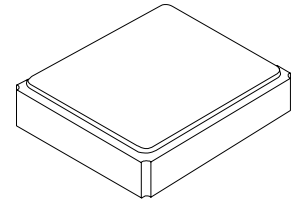

## XTL1031

## 38.4000 MHz Crystal Unit



SM3225-4 Case

- High Performance Quartz Crystal
- Excellent Frequency Stability and Reliability
- Miniature Seam-welded SMD Package
- Complies with Directive 2002/95/EC (RoHS)



The XTL1031 is a high stability 38.4000 MHz crystal suitable for a wide variety of RF communication applications.

### Electrical Characteristics

Characteristic	Sym	Notes	Minimum	Typical	Maximum	Units
Nominal Frequency	$F_O$			38.4000		MHz
Mode of Oscillation			Fundamental			
Storage Temperature Range			-40		+85	°C
Operating Temperature Range			-20		+75	°C
Frequency Stability over Operating Temperature Range			±10 ppm (referred to the value at 25 °C)			
Frequency Tolerance	$F_L$		±10 ppm @ 25 °C ±3 °C			
Equivalent Series Resistance	ESR				50	Ω
Shunt Capacitance	$C_O$				5.0	pF
Nominal Drive Level					100	μW
Load Capacitance	$C_L$			10		pF
Aging			±1 ppm/year			
Insulation Resistance, 100 VDC			500			MΩ
Standard Shipping Quantity on 178 mm (7") Reel				3000		units
Lid Symbolization			1031 YWWS			

Crystal Equivalent Circuit

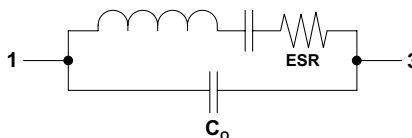

**CAUTION: Electrostatic Sensitive Device. Observe precautions for handling.**

### Notes:

1. US and international patents may apply.
2. The design, manufacturing process, and specifications of this device are subject to change without notice.
3. RFM, stylized RFM logo, and RF Monolithics, Inc. are registered trademarks of RF Monolithics, Inc.

# 4-Terminal Surface-Mount Seam Weld Case

## 3.2 x 2.5 mm Nominal Footprint

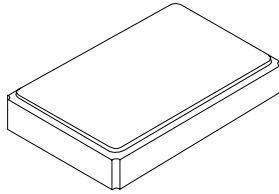

Internal Connections  
{Top View}

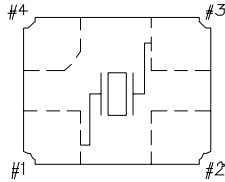

#2, #4 is connected with a cover

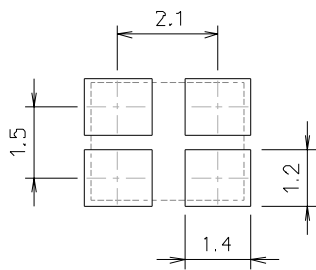
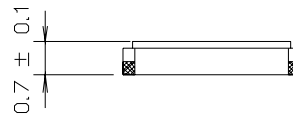
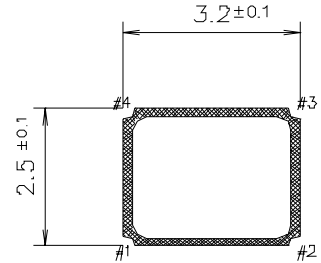

PCB Footprint (mm)

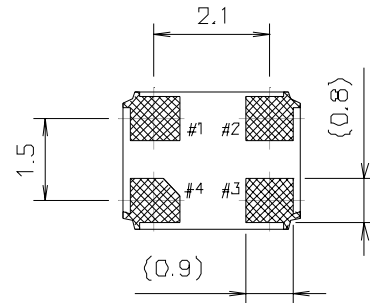

Package Dimensions

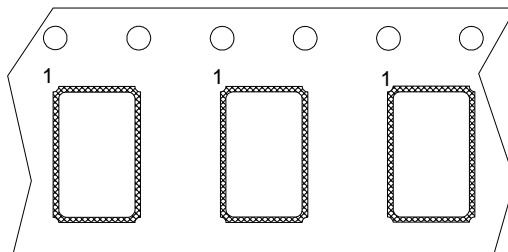

Package Orientation in Carrier Tape

# Reel Dimensions in mm

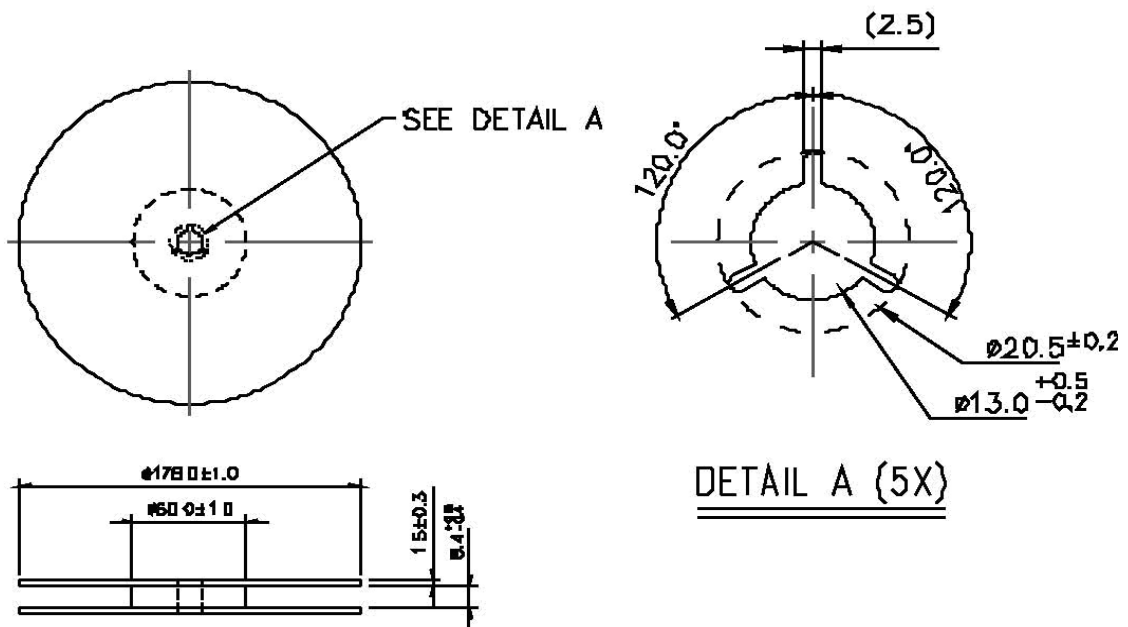

# Tape Dimensions in mm

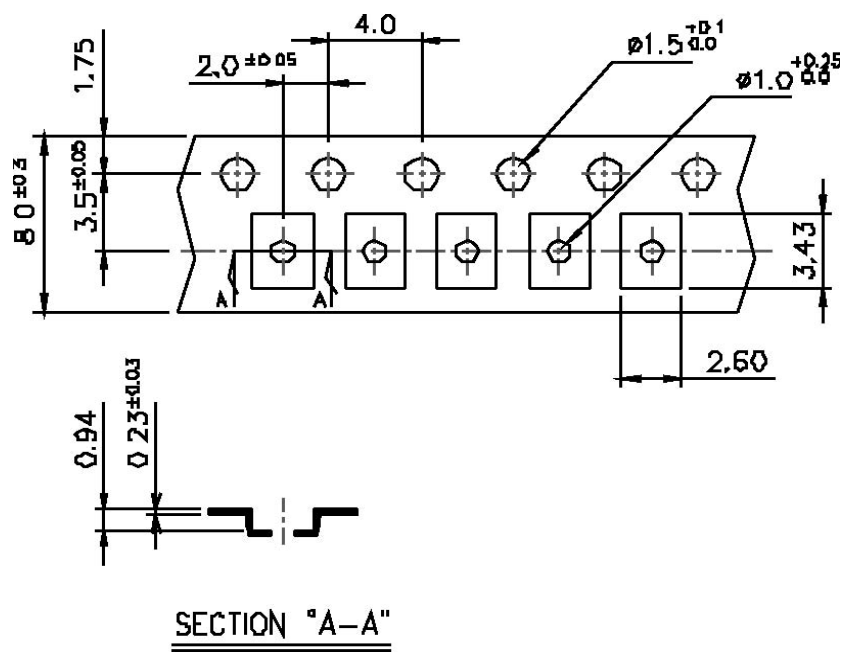

# Typical Solder Reflow Profile

