

Spezifikation für Freigabe / specification for release

Kunde / customer :
 Artikelnummer / part number : **744309047**
 Bezeichnung : **SPEICHERDROSSEL WE-HCM 1390**
 description : **POWER-CHOKE WE-HCM 1390**



DATUM / DATE : 2010-07-16

A Mechanische Abmessungen / dimensions :

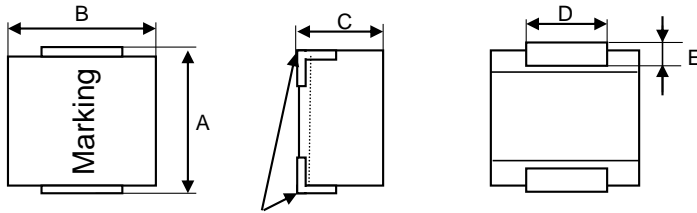

RDC is measured at these points

A	14,0 ± 0,5	mm
B	13,0 ± 0,5	mm
C	9,0 ± 0,5	mm
D	4,5 ± 0,2	mm
E	1,8 ± 0,3	mm

B Elektrische Eigenschaften / electrical properties :

Eigenschaften / properties	Testbedingungen / test conditions		Wert / value	Einheit / unit	tol.
Lerrlaufinduktivität / initial inductance	100 kHz / 10mA	L_0	470	nH	± 20%
Nenn-Induktivität / rated inductance	100 kHz / 10mA / 50A	L_N	125	nH	typ.
DC-Widerstand / DC-resistance	@ 20° C	R_{DC}	0,165	mΩ	+/-7%
Nennstrom / rated current	ΔT= 50 K	I_N	50,0	A	typ.
Sättigungsstrom / saturation current	ΔL/L₀= 20 %	I_{sat}	40,5	A	typ.
Eigenres.-Frequenz / self-res.-frequency		SRF	95	MHz	typ.

C Lötpad / soldering spec.:

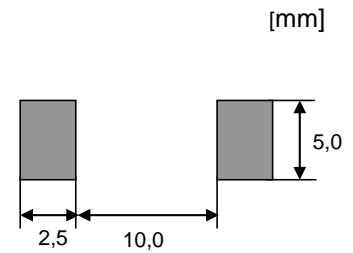

D Prüfgeräte / test equipment :

WAYNE KERR 3260B für/for L_0 ; I_{SAT}
 Agilent N5776A für/for I_{DC} ;
 Metra Hit 271 für/for R_{DC} ;

E Testbedingungen / test conditions :

Luftfeuchtigkeit / humidity: 33%
 Umgebungstemperatur / temperature: +20°C

F Werkstoffe & Zulassungen / material & approvals :

Basismaterial / base material: Ferrit/ferrite
 Endoberfläche / finishing electrode: Sn/Cu - 99.3/0.7 %
 Draht / wire: Flatwire

G Eigenschaften / general specifications :

Arbeitstemperatur / operating temperature: -40°C - +125°C
 Umgebungstemp. / ambient temperature: -40°C - +85°C
 It is recommended that the temperature of the part does not exceed 125°C under worst case operating conditions.

Freigabe erteilt / general release:	Kunde / customer		
.....	Unterschrift / signature		
Datum / date	Würth Elektronik		
.....			
Geprüft / checked	Kontrolliert / approved		
	BD	Version 1	10-07-16
	Name	Änderung / modification	Datum / date

Würth Elektronik eiSos GmbH & Co. KG

D-74638 Waldenburg · Max-Eyth-Strasse 1 - 3 · Germany · Telefon (+49) (0) 7942 - 945 - 0 · Telefax (+49) (0) 7942 - 945 - 400
<http://www.we-online.de>

Spezifikation für Freigabe / specification for release

Kunde / customer :
 Artikelnummer / part number : **744309047**
 Bezeichnung : **SPEICHERDROSSEL WE-HCM 1390**
 description : **POWER-CHOKE WE-HCM 1390**



DATUM / DATE : 2010-07-16

H Induktivitätskurve / Inductance curve :

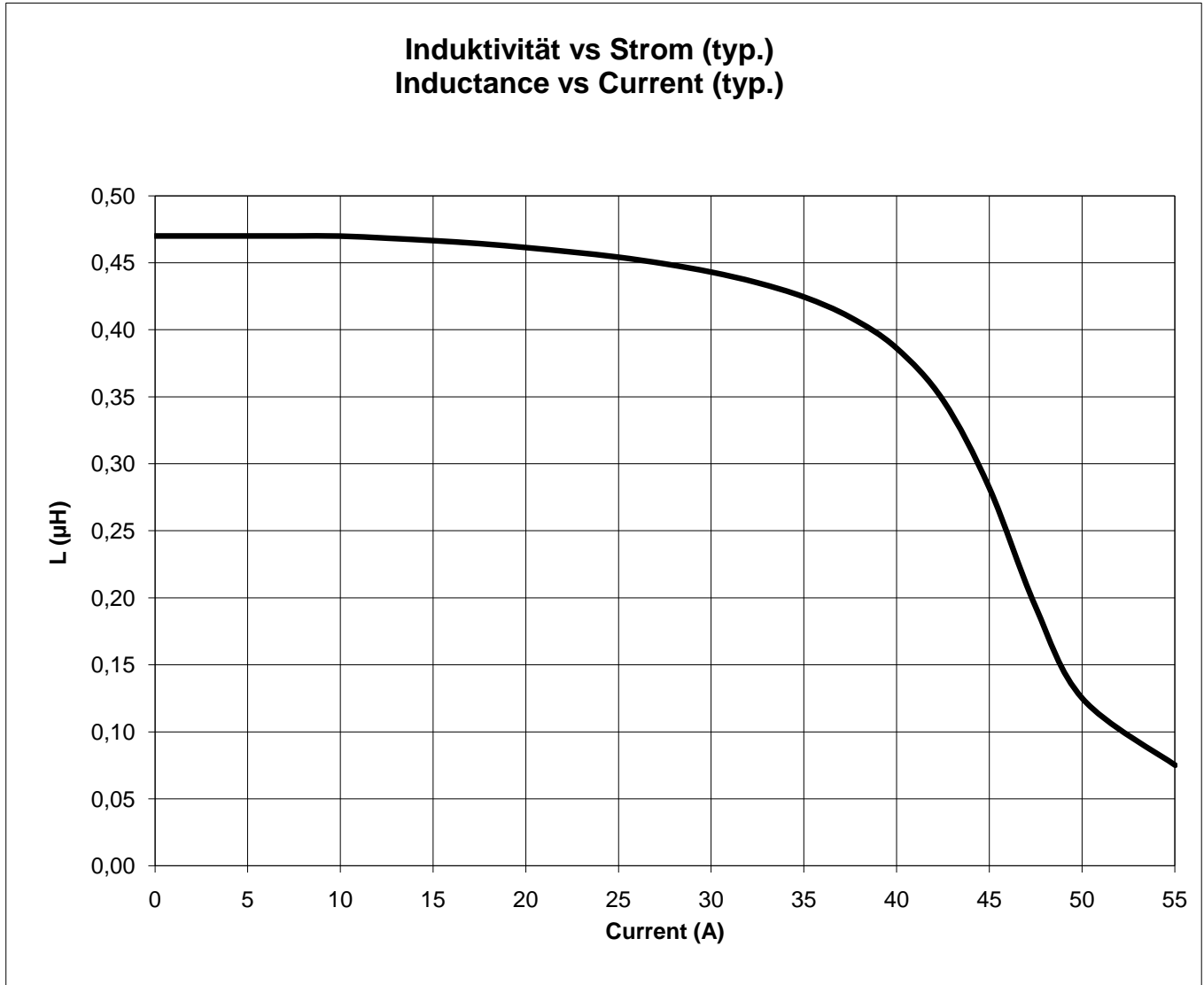

Freigabe erteilt / general release:	Kunde / customer			
Datum / date	Unterschrift / signature			
	Würth Elektronik			
Geprüft / checked	Kontrolliert / approved	BD	Version 1	10-07-16
		Name	Änderung / modification	Datum / date

Würth Elektronik eiSos GmbH & Co. KG

D-74638 Waldenburg · Max-Eyth-Strasse 1 - 3 · Germany · Telefon (+49) (0) 7942 - 945 - 0 · Telefax (+49) (0) 7942 - 945 - 400
<http://www.we-online.de>

Spezifikation für Freigabe / specification for release

Kunde / customer :
 Artikelnummer / part number : **744309047**
 Bezeichnung :
 description :



I Temperaturanstieg / Temperature rise curve :

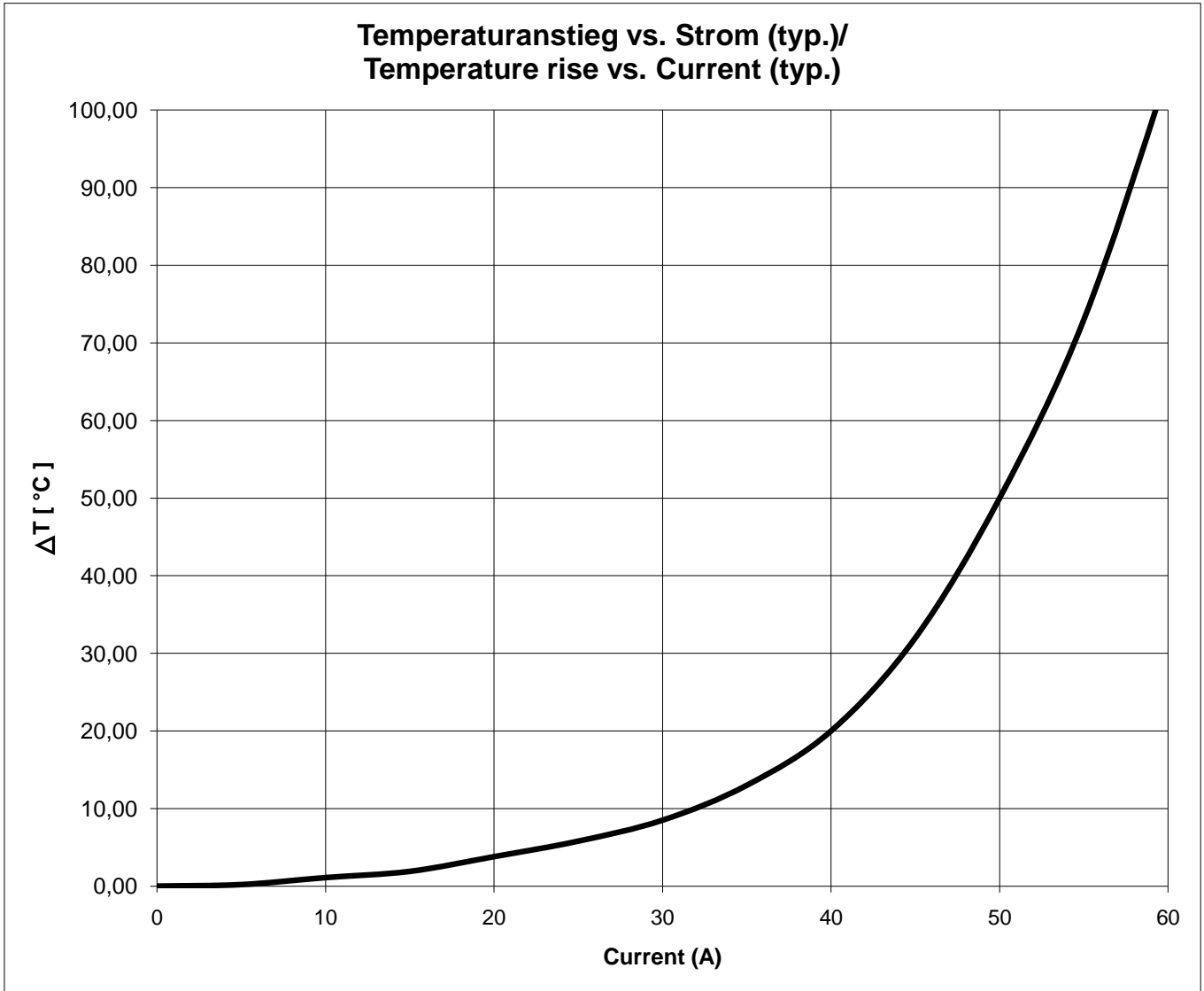

Freigabe erteilt / general release:	Kunde / customer			
			
Datum / date	Unterschrift / signature			
	Würth Elektronik			
.....	BD	Version 1	10-07-16
Geprüft / checked	Kontrolliert / approved	Name	Änderung / modification	Datum / date

Würth Elektronik eiSos GmbH & Co. KG

D-74638 Waldenburg · Max-Eyth-Strasse 1 - 3 · Germany · Telefon (+49) (0) 7942 - 945 - 0 · Telefax (+49) (0) 7942 - 945 - 400
<http://www.we-online.de>

Spezifikation für Freigabe / specification for release

Kunde / customer :

Artikelnummer / part number : **744309047**



Bezeichnung : **SPEICHERDROSSEL WE-HCM 1390**

description : **POWER-CHOKES WE-HCM 1390**

DATUM / DATE : 2010-07-16

I Rollenspezifikation / tape and reel specification :

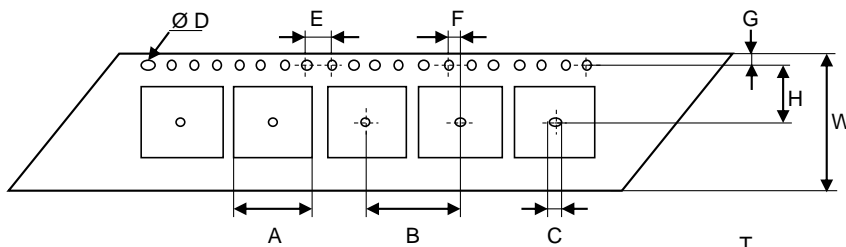

Gurtspezifikation / Tape specification:

A	13,65 ± 0,1	mm
B	20,0 ± 0,1	mm
C	1,05 typ.	mm
D	1,05 typ.	mm
E	4,00 ± 0,1	mm
F	2,00 ± 0,1	mm
G	1,75 ± 0,1	mm
H	11,5 ± 0,1	mm
I	13,2 ± 0,1	mm
J	9,20 ± 0,1	mm
T	0,40 ± 0,05	mm
W	24,0 ± 0,3	mm

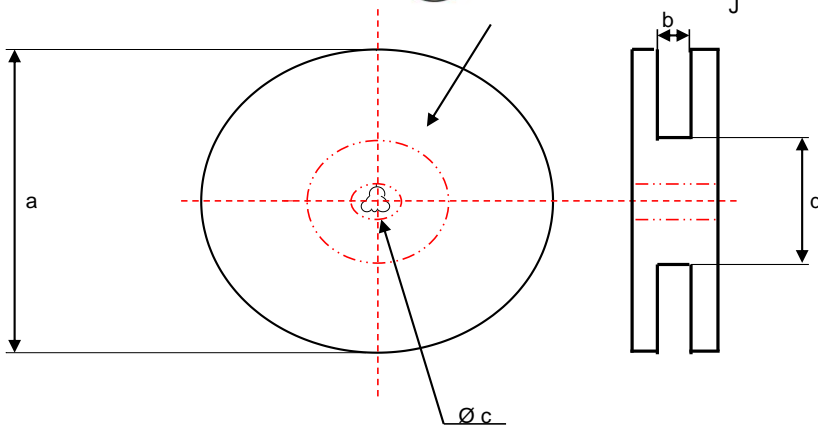

Rollenspezifikation / Reel specification:

a	330,0 (ref)	mm
b	24,0 ± 0,5	mm
c	13,5 ± 0,5	mm
d	100,0 ± 1,5	mm

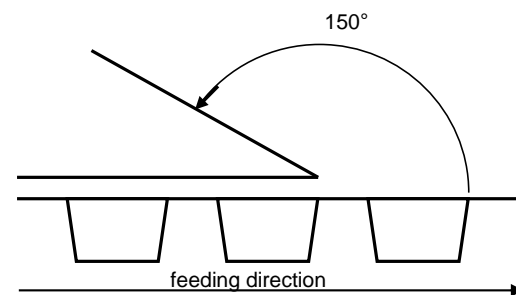

The Force for tearing off cover tape is 20 to 70 grams in arrow direction

Freigabe erteilt / general release:	Kunde / customer			
Datum / date	Unterschrift / signature			
	Würth Elektronik			
Geprüft / checked	Kontrolliert / approved	BD	Version 1	10-07-16
		Name	Änderung / modification	Datum / date

Würth Elektronik eiSos GmbH & Co. KG

D-74638 Waldenburg · Max-Eyth-Strasse 1 - 3 · Germany · Telefon (+49) (0) 7942 - 945 - 0 · Telefax (+49) (0) 7942 - 945 - 400
<http://www.we-online.com>

This electronic component is designed and developed with the intention for use in general electronics equipments. Before incorporating the components into any equipments in the field such as aerospace, aviation, nuclear control, submarine, transportation, (automotive control, train control, ship control), transportation signal, disaster prevention, medical, public information network etc. where higher safety and reliability are especially required or if there is possibility of direct damage or injury to human body. In addition, even electronic component in general electronic equipments, when used in electrical circuits that require high safety, reliability functions or performance, the sufficient reliability evaluation-check for the safety must be performed before use. It is essential to give consideration when to install a protective circuit at the design stage.