



FR1601G THRU FR1607G

16.0 AMPS. Glass Passivated Fast Recovery Rectifiers



Voltage Range
50 to 1000 Volts
Current
16.0 Amperes

Features

- ✧ Low forward voltage drop
- ✧ High current capability
- ✧ High reliability
- ✧ High surge current capability

Mechanical Data

- ✧ Cases: TO-220 molded plastic
- ✧ Epoxy: UL 94V-0 rate flame retardant
- ✧ Terminals: Leads solderable per MIL-STD-202, Method 208 guaranteed
- ✧ Polarity: As marked
- ✧ High temperature soldering guaranteed: 260°C/10 seconds .16", (4.06mm) from case.
- ✧ Mounting position: Any
- ✧ Weight: 2.24 grams

TO-220

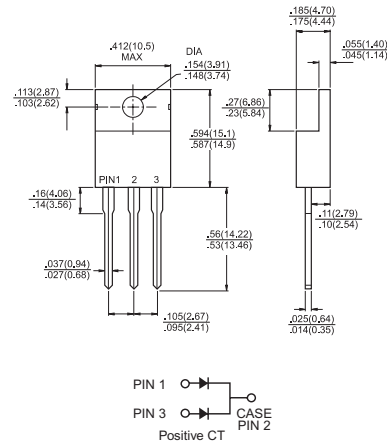

Dimensions in inches and (millimeters)

Maximum Ratings and Electrical Characteristics

Rating at 25°C ambient temperature unless otherwise specified.

Single phase, half wave, 60 Hz, resistive or inductive load.

For capacitive load, derate current by 20%

Type Number	Symbol	FR 1601G	FR 1602G	FR 1603G	FR 1604G	FR 1605G	FR 1606G	FR 1607G	Units
Maximum Recurrent Peak Reverse Voltage	V_{RRM}	50	100	200	400	600	800	1000	V
Maximum RMS Voltage	V_{RMS}	35	70	140	280	420	560	700	V
Maximum DC Blocking Voltage	V_{DC}	50	100	200	400	600	800	1000	V
Maximum Average Forward Rectified Current See Fig. 2	$I_{(AV)}$	16.0							A
Peak Forward Surge Current, 8.3 ms Single Half Sine-wave Superimposed on Rated Load (JEDEC method)	I_{FSM}	150							A
Maximum Instantaneous Forward Voltage @ 8.0A	V_F	1.3							V
Maximum DC Reverse Current @ $T_C=25^\circ\text{C}$ at Rated DC Blocking Voltage @ $T_C=125^\circ\text{C}$	I_R	5.0 100							μA μA
Maximum Reverse Recovery Time (Note 1)	T_{rr}	150				250	500		nS
Typical Thermal Resistance (Note 2)	$R_{\theta JC}$	3.0							$^\circ\text{C}/\text{W}$
Operating and Storage Temperature Range	T_J, T_{STG}	-65 to +150							$^\circ\text{C}$

Notes: 1. Reverse Recovery Test Conditions: $I_F=0.5\text{A}$, $I_R=1.0\text{A}$, $I_{RR}=0.25\text{A}$

2. Thermal Resistance from Junction to Case Per Leg Mounted on Heatsink size 2" x 3" x 0.25" Al-Plate

RATINGS AND CHARACTERISTIC CURVES (FR1601G THRU FR1607G)

FIG.1- REVERSE RECOVERY TIME CHARACTERISTIC AND TEST CIRCUIT DIAGRAM

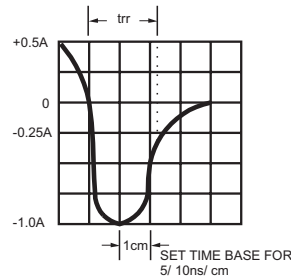
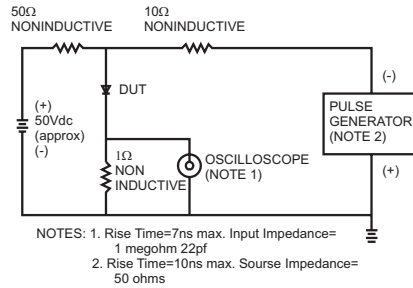

FIG.2- MAXIMUM FORWARD CURRENT DERATING CURVE

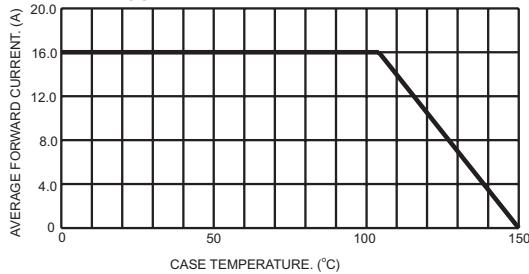

FIG.3- TYPICAL REVERSE CHARACTERISTICS PER LEG

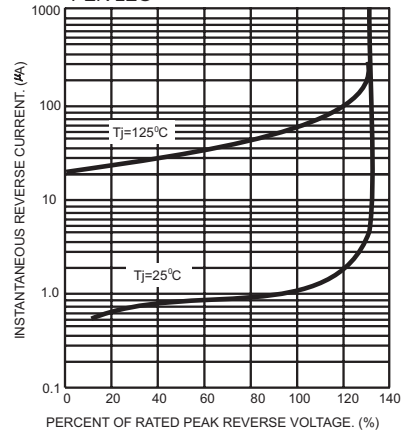

FIG.4- MAXIMUM NON-REPETITIVE FORWARD SURGE CURRENT PER LEG

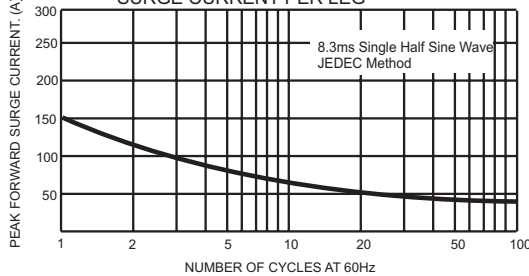

FIG.6- TYPICAL INSTANTANEOUS FORWARD CHARACTERISTICS PER LEG

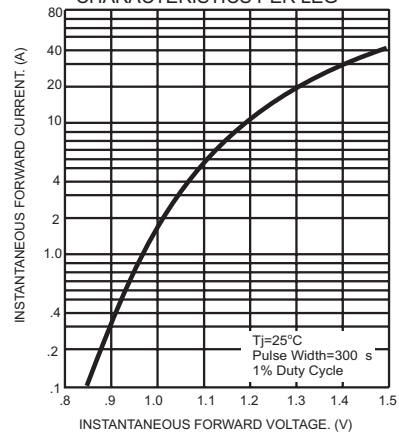

FIG.5- TYPICAL JUNCTION CAPACITANCE PER LEG

