

Monocolor Flexible SMD LED PRODUCT SPECIFICATION

Model No.: FYSH-5050RGB-30-12V-WW10

Features:

The application of soft & flexible PCB makes the strip possible to be bent into any shape as per users' needs. The viewing angle as wide as 120° and adjustable length by cutting off or connecting every three LED's enable it to be more suitable for the applications of signs, advertisements and backlights.

Applications:

- Channel Letters
- Lighting source for shop windows
- Indoor Decoration Lighting
- Advertising Signs
- Replacement for Neon



CUSTOMER APPROVED SIGNATURES	APPROVED BY	CHECKED BY	PREPARED BY

NINGBO FORYARD OPTOELECTRONICS CO.,LTD.

Add:NO.115 Qixin Road Ningbo Zhejiang China

Zip:315051

Tel: 0086-574-87933652 87927870 87922206

Fax: 0086-574-87927917

E-mail:Sales@foryard.com (General)

[Http://www.foryard.com](http://www.foryard.com)

Model No.: FYSH-5050RGB-30-12V-WW10

Photo



Drawing (1 meter)

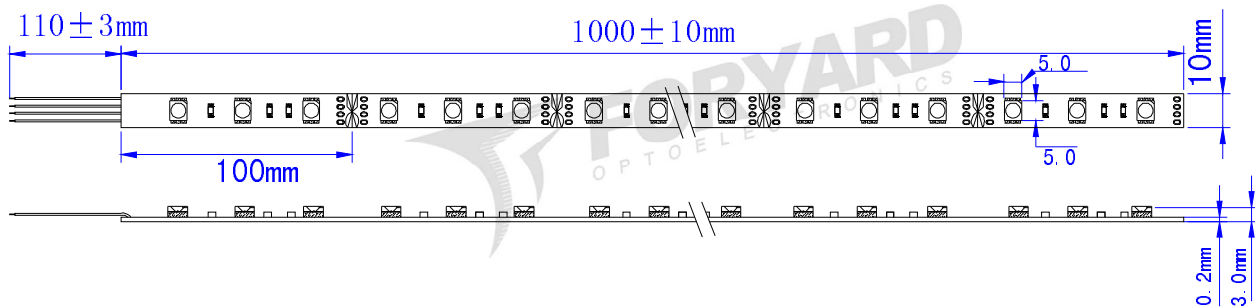

Notes:

1. All dimensions are millimeters.
2. Tolerance is $\pm 0.2\text{mm}$ unless otherwise specified.
3. Specifications are subject to change without notice.
4. Dimension: L1000*W10*H3.0mm.without prior notice.
5. Can be cut or connected every three LEDs.

Circuit Diagram(a single group)

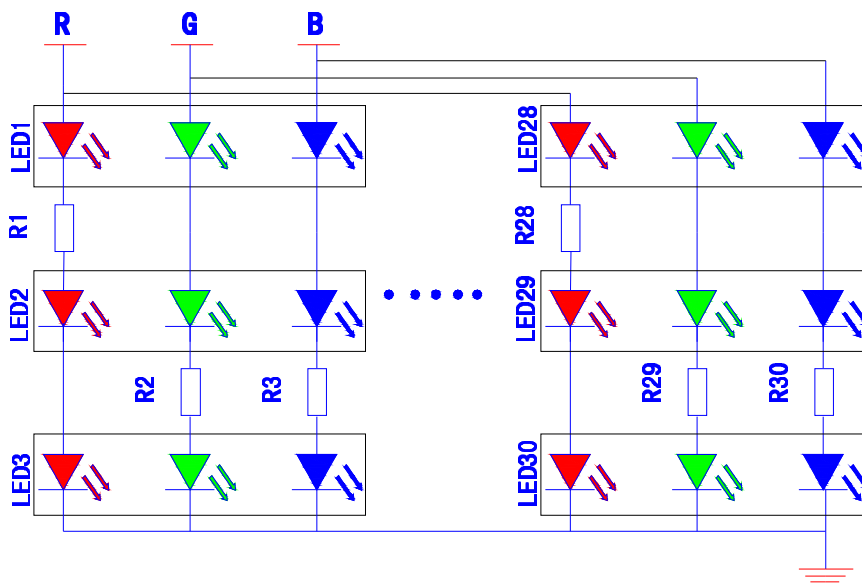

Model No.: FYSH-5050RGB-30-12V-WW10

■ Rating Electrical/Optical Characteristics(1 meter)

Item	Red	Blue	Green	White
Operation Voltage(V)	DC12	DC12	DC12	DC12
Power Dissipation(V)	2.4	2.4	2.4	14.4
Input Current(mA)	200	200	200	600
Wavelength(nm)	625-635	465-475	515-525	/
Single LED Luminous Intensity(MCD)	780	400	1500	2680
Luminous Flux(lm)	70	33	150	253
Angle(°)	120			
Operation Temperature(°C)	-20~60			
single LED Operating	20	20	20	60
LED Quantity(pcs)	30			
Dimension:(mm)	L1000*W10*H3mm			
Life Time(hrs)	50000			
net weight:(g)	40			
Approval	CE(NO:E8N 08 03 57489 002)			

■ Rating Electrical/Optical Characteristics(5 meter)

Item	Red	Blue	Green	White
Power Dissipation	12W	12W	12W	36W
Total Length	5m±0.5mm	5m±0.5mm	5m±0.5mm	5m±0.5mm.
Input Current(mA)	1000	1000	1000	3000
Weight	200g	200g	200g	200g

Model No.: FYSH-5050RGB-30-12V-WW10

Package(5 meters)

The backsides of all products will stick '3M' branded double-sided sticker with 10mm width.

Reel

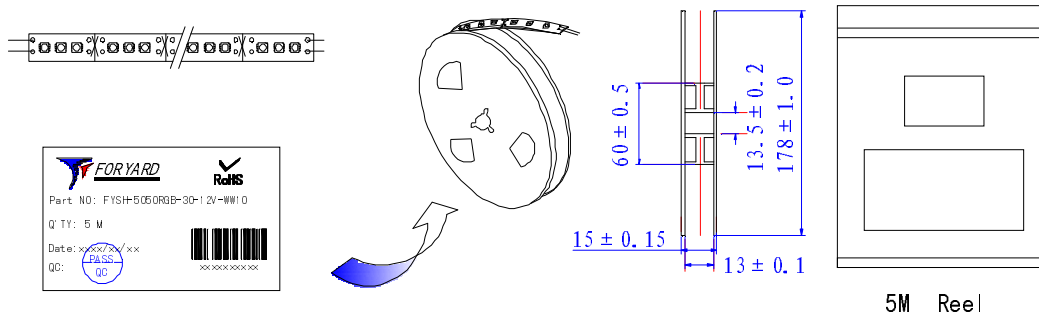

5M Reel

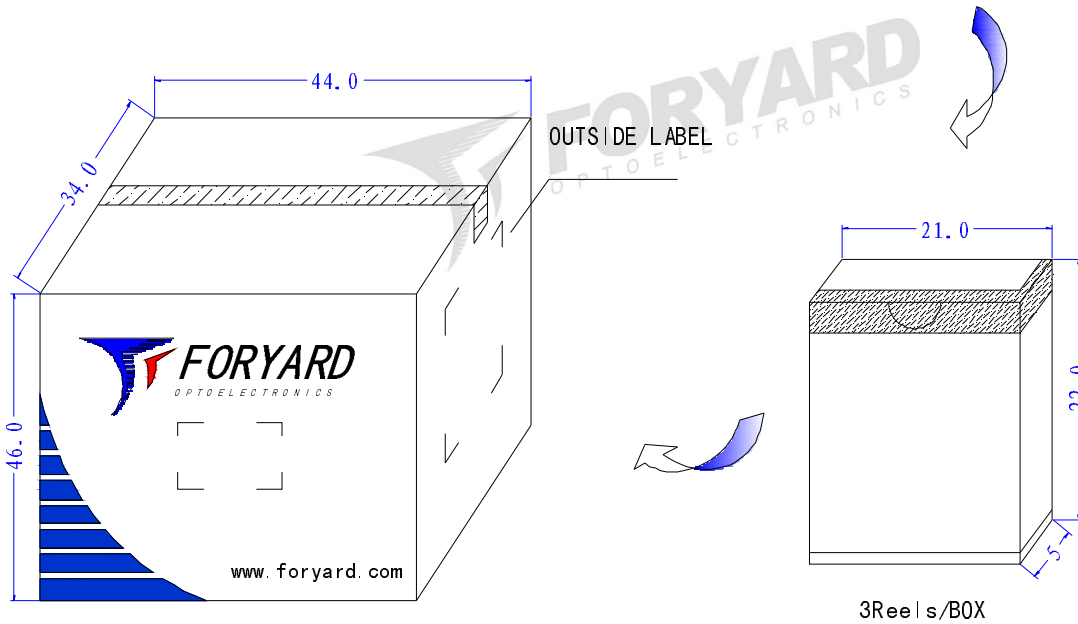

24Boxes/ Carton

3Reels/BOX



OUTSIDE LABEL

Model No.: FYSH-5050RGB-30-12V-WW10

■ **How to use:**

1. Please use this product with 12V DC.
2. Please complete the ESD-prevention before using.
3. The flexible LED strips should be neither bent into right-angles nor folded.
4. For this product, every three LEDs on the same strip can be cut off and use separately (namely, every 100mm works as a group). Please refer to the 'Outline' for the details.
5. The calculating way that how many this product a power supply can upload is: the current(A) that the power supply can offer/the current distributed to each single group*total group of this product
6. The strip quantity of each sting that directly connected to the power supply should not exceed 30 PCS; otherwise, the brightness of the strip at the end of the string will be dimmed because of the voltage reduction. Although a loop circuit can avoid reduction happening, one string should not connect too many strips.
7. The wire with gray line is anode, while the red · green · blue · yellow · white is cathode, If polarities connected in a wrong way, the strip will not be lit, but will not be damaged either. What only needs to do is changing the polarity connection.
8. When installing the strips in the plastic letters or characters, please try to use 3 or 4 branch wires and when doing the connection try to make the strips in a letter or character or box form a loop circuit or several loop circuits by using red and black wire to connect the strips at the end of the strokes together according to their polarities.
9. This product is water-proof.
10. When installing the strip, the double-sided adhesive tape or carpenter's glue is required to make the clip slot of the strip firmly stuck together. When using the double-sided adhesive tape, proper glass glue must be spread to avoid the strip falling off after long-time exposed in the sunlight.
11. The strip quantity of each sting that directly connected to the power supply should not exceed 30pcs; otherwise, the brightness of the strip at the end of the string will be dimmed because of the voltage reduction. Although a loop circuit can avoid reduction happening, one string should not connect too many strips.
12. No push, squeeze or press on the components of the strip for fear damaging the components to affect the lighting effects.