

## Power SMD LED in PLCC-3 Package

### Description

The TLM.32.. series is an advanced development in terms of heat dissipation.

The leadframe profile of this PLCC-3 SMD package is optimized to reduce the thermal resistance.

This allows higher drive current and doubles the light output compared to Vishay's high intensity SMD LED in PLCC-2 package.

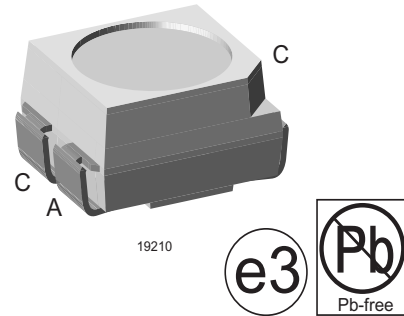

### Features

- Utilizing AlInGaP technology
- Angle of half intensity  $\pm \varphi = 60^\circ$
- Available in 8 mm tape
- Luminous intensity, color and forward voltage categorized per packing unit
- Luminous intensity ratio per packing unit  $I_{Vmax}/I_{Vmin} \leq 1.6$
- ESD class 2
- Suitable for all soldering methods according to CECC
- Lead-free device

### Applications

Traffic Signals and Signs  
 Interior and exterior lighting  
 Dashboard illumination  
 Indicator and backlighting purposes for audio, video, LCD's switches, symbols, illuminated advertising etc.

### Parts Table

Part	Color, Luminous Intensity	Dominant Wavelength
TLMK3200	Red, $I_V > 200$ mcd (typ. 500 mcd)	611 nm to 622 nm
TLMK3201	Red, $I_V = (250$ to 800) mcd	611 nm to 622 nm
TLMK3202	Red, $I_V = (320$ to 800) mcd	611 nm to 622 nm
TLMK3203	Red, $I_V = (400$ to 1250) mcd	611 nm to 622 nm
TLMS3200	Red, $I_V > 160$ mcd (typ. 300 mcd)	626 nm to 638 nm
TLMS3201	Red, $I_V = (160$ to 400) mcd	626 nm to 638 nm
TLMS3202	Red, $I_V = (250$ to 800) mcd	626 nm to 638 nm
TLMO3200	Soft orange, $I_V > 200$ mcd (typ. 500 mcd)	600 nm to 611 nm
TLMO3201	Soft orange, $I_V = (250$ to 800) mcd	600 nm to 611 nm
TLMO3202	Soft orange, $I_V = (320$ to 800) mcd	600 nm to 611 nm
TLMO3203	Soft orange, $I_V = (400$ to 1250) mcd	600 nm to 611 nm
TLMY3200	Yellow, $I_V > 200$ mcd (typ. 450 mcd)	583 nm to 594 nm
TLMY3201	Yellow, $I_V = (250$ to 800) mcd	583 nm to 594 nm
TLMY3202	Yellow, $I_V = (320$ to 800) mcd	583 nm to 594 nm
TLMY3203	Yellow, $I_V = (400$ to 1250) mcd	583 nm to 594 nm

### Absolute Maximum Ratings

$T_{amb} = 25\text{ }^{\circ}\text{C}$ , unless otherwise specified

TLMK32.., TLMS32.., TLMO32.., TLMY32..

Parameter	Test condition	Symbol	Value	Unit
Reverse voltage		$V_R$	5	V
Forward current		$I_F$	70	mA
Power dissipation	$T_{amb} \leq 65\text{ }^{\circ}\text{C}$ (290 K/W), $T_{amb} \leq 70\text{ }^{\circ}\text{C}$ (270 K/W)	$P_{tot}$	180	mW
Junction temperature		$T_j$	125	$^{\circ}\text{C}$
Operating temperature range		$T_{amb}$	- 40 to + 100	$^{\circ}\text{C}$
Storage temperature range		$T_{stg}$	- 40 to + 100	$^{\circ}\text{C}$
Thermal resistance junction/ambient	mounted on PC board FR4 optional padder design (see page 12)	$R_{thJA}$	290	K/W
	mounted on PC board FR4 recommended padder design (see page 11)	$R_{thJA}$	270	K/W

### Optical and Electrical Characteristics

$T_{amb} = 25\text{ }^{\circ}\text{C}$ , unless otherwise specified

#### Red

TLMK32..

Parameter	Test condition	Part	Symbol	Min	Typ.	Max	Unit
Luminous intensity	$I_F = 50\text{ mA}$	TLMK3200	$I_V$	200	500		mcd
		TLMK3201	$I_V$	250		800	mcd
		TLMK3202	$I_V$	320		800	mcd
		TLMK3203	$I_V$	400		1250	mcd
Luminous flux/Luminous intensity			$\phi_V/I_V$		3		mlm/mcd
Dominant wavelength	$I_F = 50\text{ mA}$		$\lambda_d$	611	617	622	nm
Peak wavelength	$I_F = 50\text{ mA}$		$\lambda_p$		624		nm
Spectral bandwidth at 50 % $I_{rel\ max}$	$I_F = 50\text{ mA}$		$\Delta\lambda$		18		nm
Angle of half intensity	$I_F = 50\text{ mA}$		$\varphi$		$\pm 60$		deg
Forward voltage	$I_F = 50\text{ mA}$		$V_F$	1.85	2.1	2.55	V
Reverse current	$V_R = 5\text{ V}$		$V_R$		0.01	10	$\mu\text{A}$

#### Red

TLMS32..

Parameter	Test condition	Part	Symbol	Min	Typ.	Max	Unit
Luminous intensity	$I_F = 50\text{ mA}$	TLMS3200	$I_V$	160	300		mcd
		TLMS3201	$I_V$	160		400	mcd
		TLMS3202	$I_V$	250		800	mcd
Luminous flux/Luminous intensity			$\phi_V/I_V$		3		mlm/mcd
Dominant wavelength	$I_F = 50\text{ mA}$		$\lambda_d$	626	630	638	nm
Peak wavelength	$I_F = 50\text{ mA}$		$\lambda_p$		641		nm



Parameter	Test condition	Part	Symbol	Min	Typ.	Max	Unit
Spectral bandwidth at 50 % $I_{rel\ max}$	$I_F = 50\ mA$		$\Delta\lambda$		17		nm
Angle of half intensity	$I_F = 50\ mA$		$\varphi$		$\pm 60$		deg
Forward voltage	$I_F = 50\ mA$		$V_F$	1.85	2.1	2.55	V
Reverse current	$V_R = 5\ V$		$V_R$		0.01	10	$\mu A$

### Soft Orange

#### TLMO32..

Parameter	Test condition	Part	Symbol	Min	Typ.	Max	Unit
Luminous intensity	$I_F = 50\ mA$	TLMO3200	$I_V$	200	500		mcd
		TLMO3201	$I_V$	250		800	mcd
		TLMO3202	$I_V$	320		800	mcd
		TLMO3203	$I_V$	400		1250	mcd
Luminous flux/Luminous intensity			$\phi_V/I_V$		3		mlm/mcd
Dominant wavelength	$I_F = 50\ mA$		$\lambda_d$	600	605	611	nm
Peak wavelength	$I_F = 50\ mA$		$\lambda_p$		611		nm
Spectral bandwidth at 50 % $I_{rel\ max}$	$I_F = 50\ mA$		$\Delta\lambda$		17		nm
Angle of half intensity	$I_F = 50\ mA$		$\varphi$		$\pm 60$		deg
Forward voltage	$I_F = 50\ mA$		$V_F$	1.85	2.1	2.55	V
Reverse current	$V_R = 5\ V$		$V_R$		0.01	10	$\mu A$

### Yellow

#### TLMY32..

Parameter	Test condition	Part	Symbol	Min	Typ.	Max	Unit
Luminous intensity	$I_F = 50\ mA$	TLMY3200	$I_V$	200	450		mcd
		TLMY3201	$I_V$	250		800	mcd
		TLMY3202	$I_V$	320		800	mcd
		TLMY3203	$I_V$	400		1250	mcd
Luminous flux/Luminous intensity			$\phi_V/I_V$		3		mlm/mcd
Dominant wavelength	$I_F = 50\ mA$		$\lambda_d$	583	588	594	nm
Peak wavelength	$I_F = 50\ mA$		$\lambda_p$		590		nm
Spectral bandwidth at 50 % $I_{rel\ max}$	$I_F = 50\ mA$		$\Delta\lambda$		18		nm
Angle of half intensity	$I_F = 50\ mA$		$\varphi$		$\pm 60$		deg
Forward voltage	$I_F = 50\ mA$		$V_F$	1.85	2.1	2.55	V
Reverse current	$V_R = 5\ V$		$V_R$		0.01	10	$\mu A$

### Typical Characteristics ( $T_{amb} = 25\text{ }^{\circ}\text{C}$ unless otherwise specified)

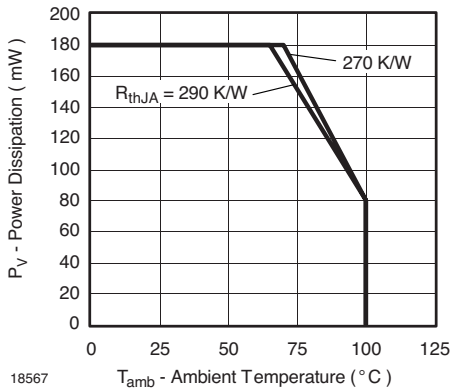

Figure 1. Power Dissipation vs. Ambient Temperature

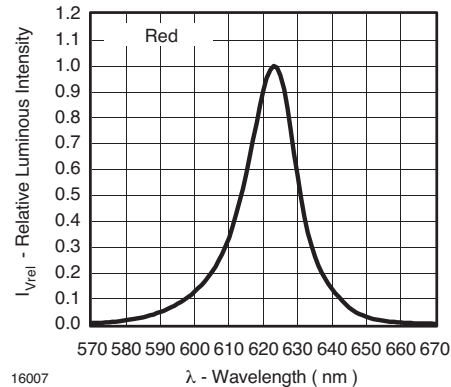

Figure 4. Relative Intensity vs. Wavelength

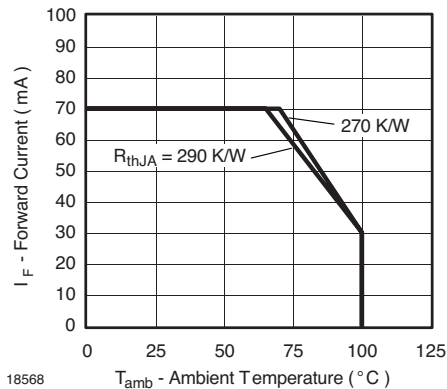

Figure 2. Forward Current vs. Ambient Temperature

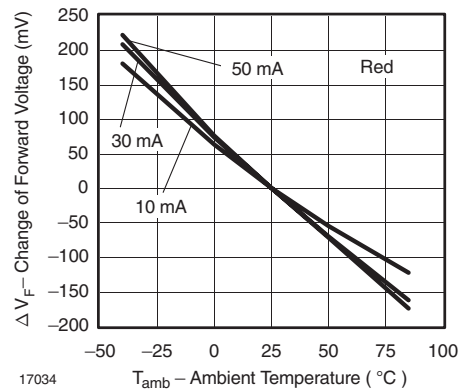

Figure 5. Change of Forward Voltage vs. Ambient Temperature

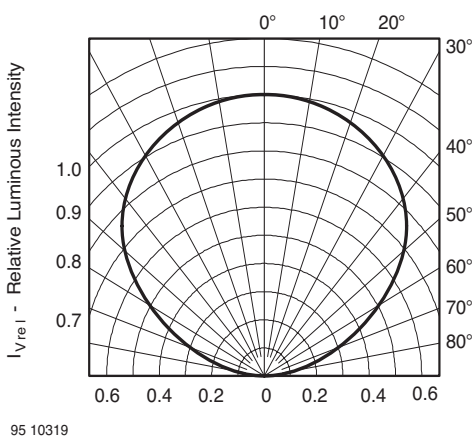

Figure 3. Rel. Luminous Intensity vs. Angular Displacement

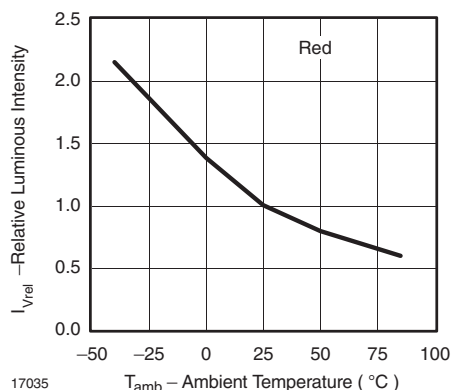

Figure 6. Relative Luminous Intensity vs. Amb. Temperature

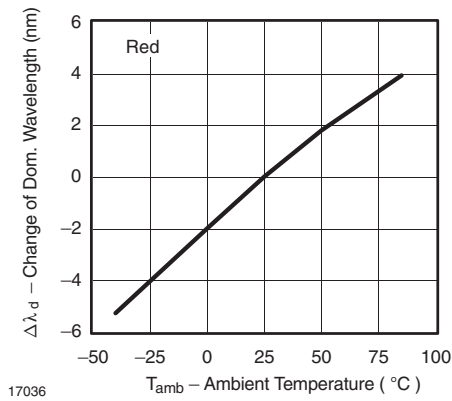

Figure 7. Change of Dominant Wavelength vs. Ambient Temperature

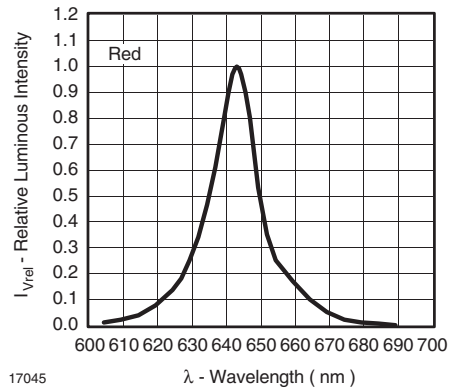

Figure 10. Relative Intensity vs. Wavelength

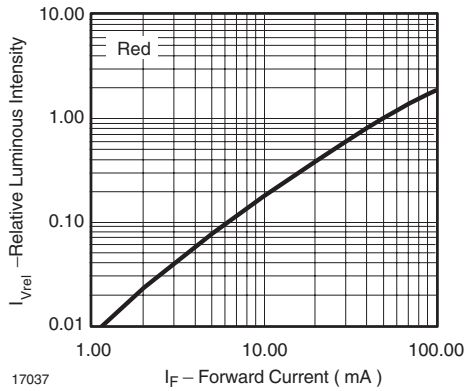

Figure 8. Relative Luminous Intensity vs. Forward Current

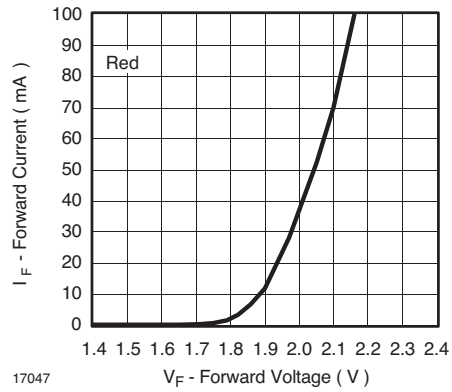

Figure 11. Forward Current vs. Forward Voltage

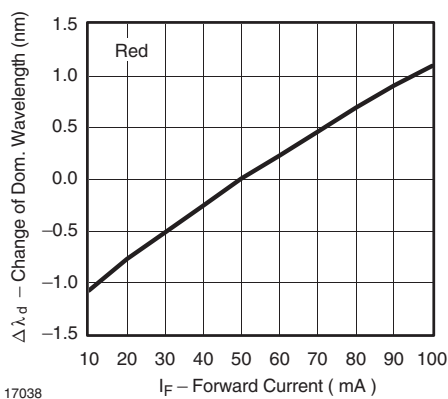

Figure 9. Change of Dominant Wavelength vs. Forward Current

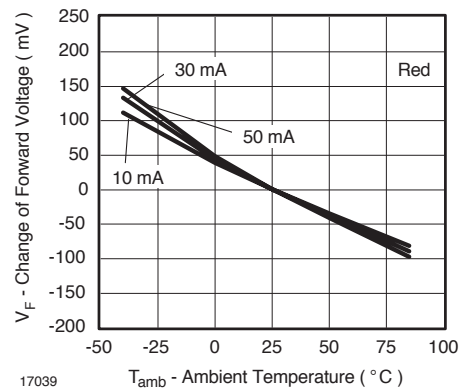

Figure 12. Change of Forward Voltage vs. Ambient Temperature

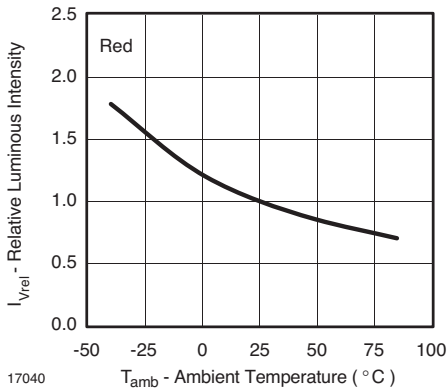

Figure 13. Relative Luminous Intensity vs. Amb. Temperature

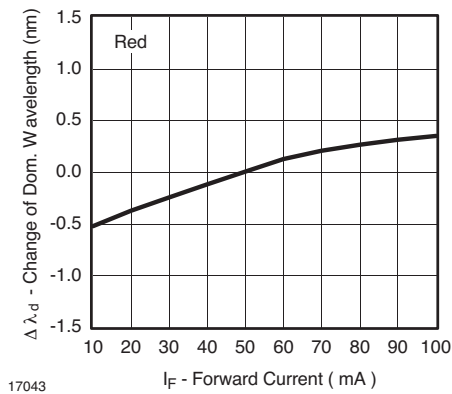

Figure 16. Change of Dominant Wavelength vs. Forward Current

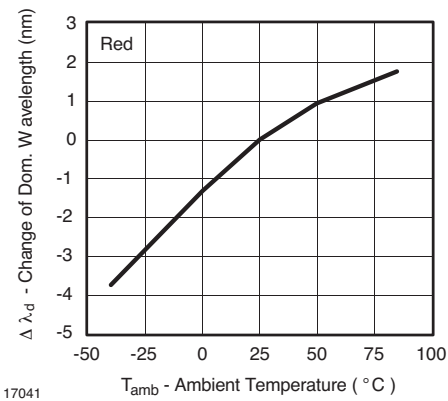

Figure 14. Change of Dominant Wavelength vs. Ambient Temperature

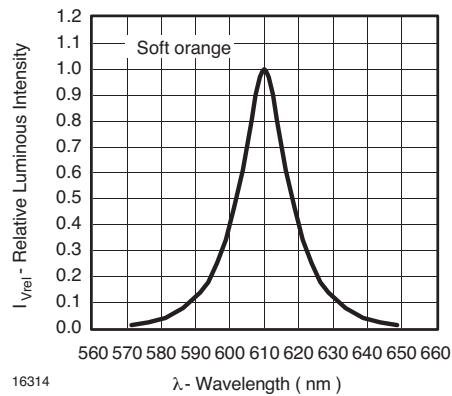

Figure 17. Relative Intensity vs. Wavelength

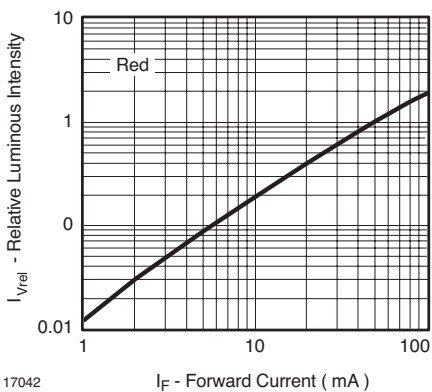

Figure 15. Relative Luminous Intensity vs. Forward Current

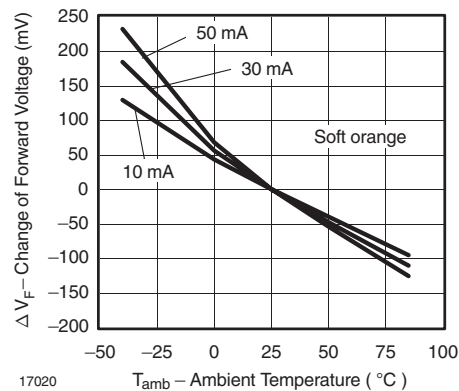

Figure 18. Change of Forward Voltage vs. Ambient Temperature

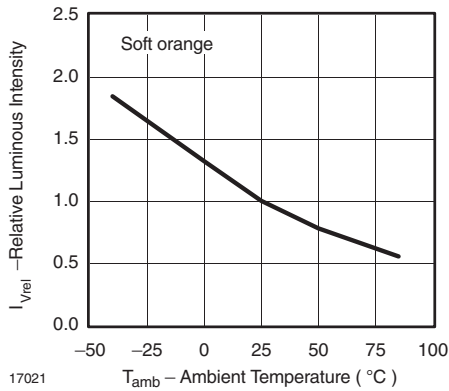

Figure 19. Relative Luminous Intensity vs. Amb. Temperature

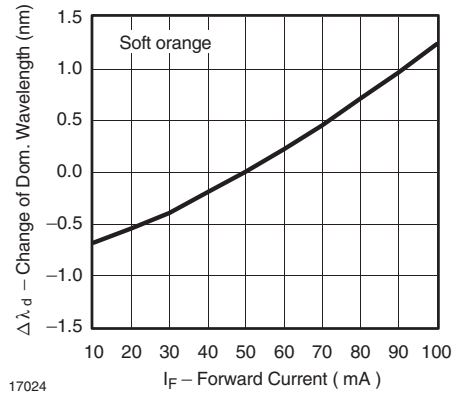

Figure 22. Change of Dominant Wavelength vs. Forward Current

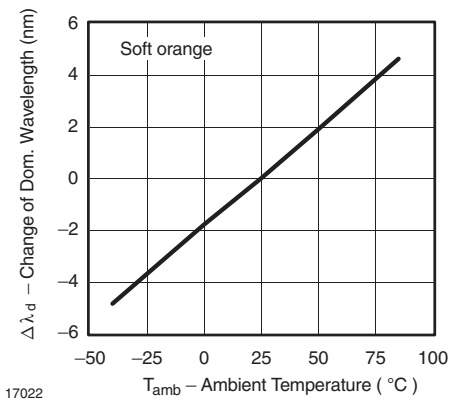

Figure 20. Change of Dominant Wavelength vs. Ambient Temperature

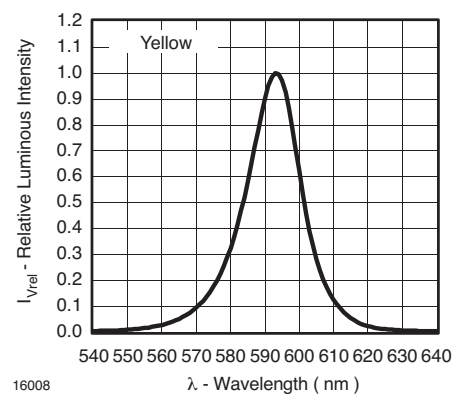

Figure 23. Relative Intensity vs. Wavelength

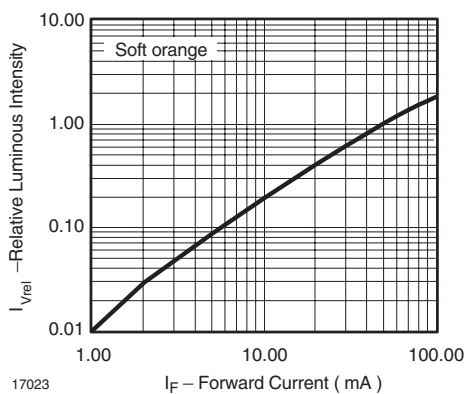

Figure 21. Relative Luminous Intensity vs. Forward Current

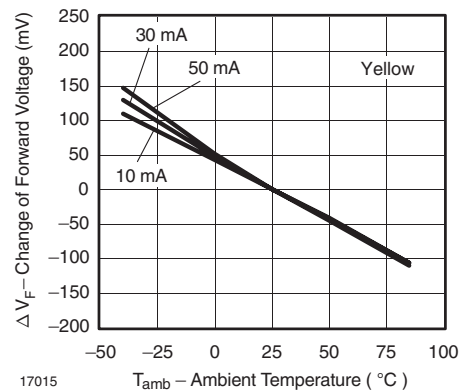

Figure 24. Change of Forward Voltage vs. Ambient Temperature

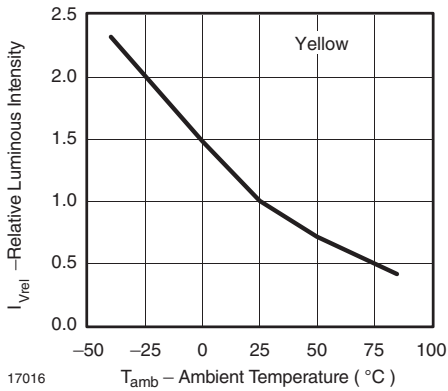

Figure 25. Relative Luminous Intensity vs. Amb. Temperature

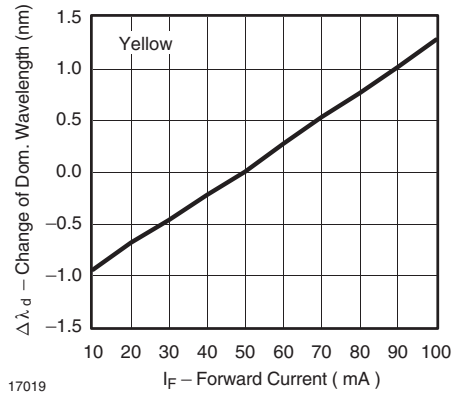

Figure 28. Change of Dominant Wavelength vs. Forward Current

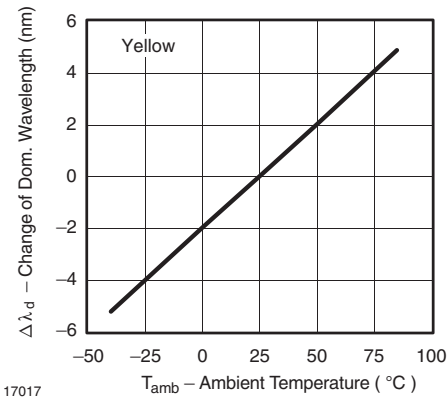

Figure 26. Change of Dominant Wavelength vs. Ambient Temperature

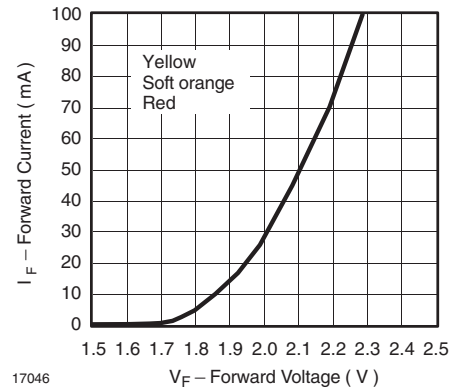

Figure 29. Forward Current vs. Forward Voltage

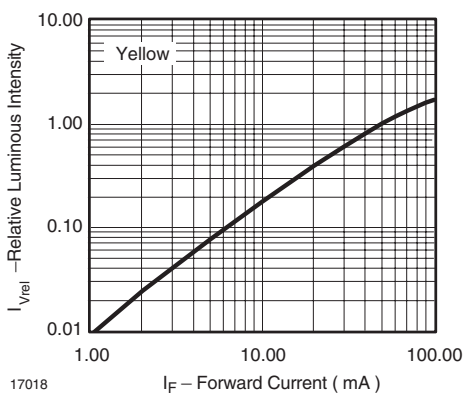

Figure 27. Relative Luminous Intensity vs. Forward Current

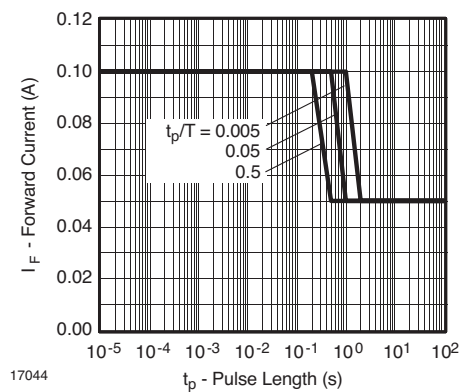

Figure 30. Forward Current vs. Pulse Length





## Forward Voltage Classification

Group	Forward Voltage (V)	
	min	max
1	1.85	2.25
2	2.15	2.55

## Color Classification

Group	Dominant Wavelength (nm)					
	Red		Soft Orange		Yellow	
	min	max	min	max	min	max
1	611	618	598	601	581	584
2	614	622	600	603	583	586
3			602	605	585	588
4			604	607	587	590
5			606	609	589	592
6			608	611	591	594

## Luminous Intensity Classification

Group	Luminous Intensity (mcd)	
	min	max
Xa	160	250
Xb	200	320
Ya	250	400
Yb	320	500
Za	400	630
Zb	500	800
0a	630	1000
0b	800	1250

## Group Name on Label

Luminous Intensity Group	Halfgroup	Wavelength	Forward Voltage
Z	b	2	1

One packing unit/tape contains only one classification group of luminous intensity, color and forward voltage

Only one single classification groups is not available

The given groups are not order codes, customer specific group combinations require marketing agreement

No color subgrouping for Super Red

## Taping

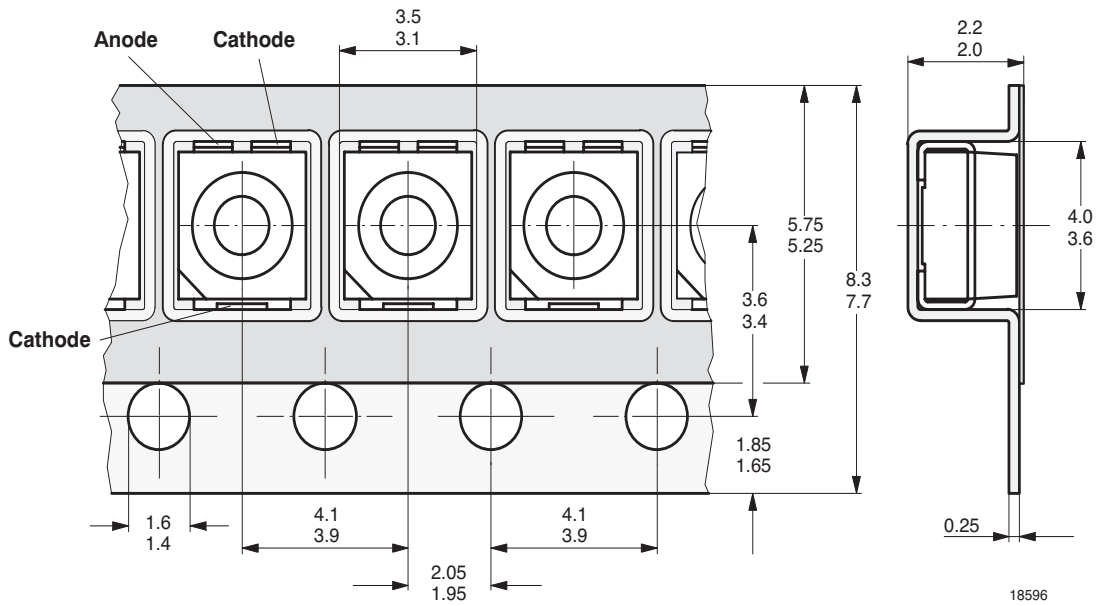

Tape Dimensions in mm for PLCC-3

## Recommended Pad Design

(Wave-Soldering),  $R_{thJA} = 270 \text{ K/W}$

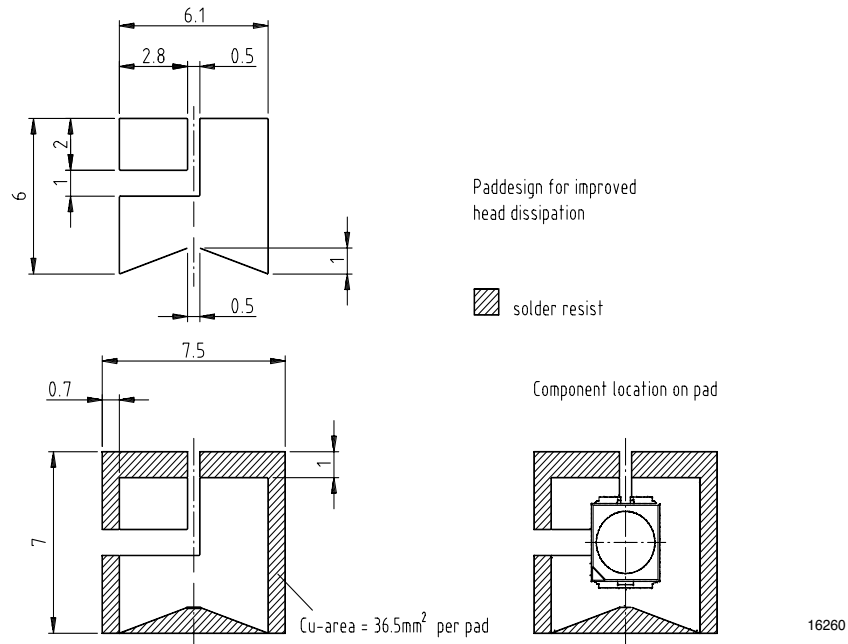

## Recommended Pad Design

(Reflow-Soldering),  $R_{thJA} = 270 \text{ K/W}$

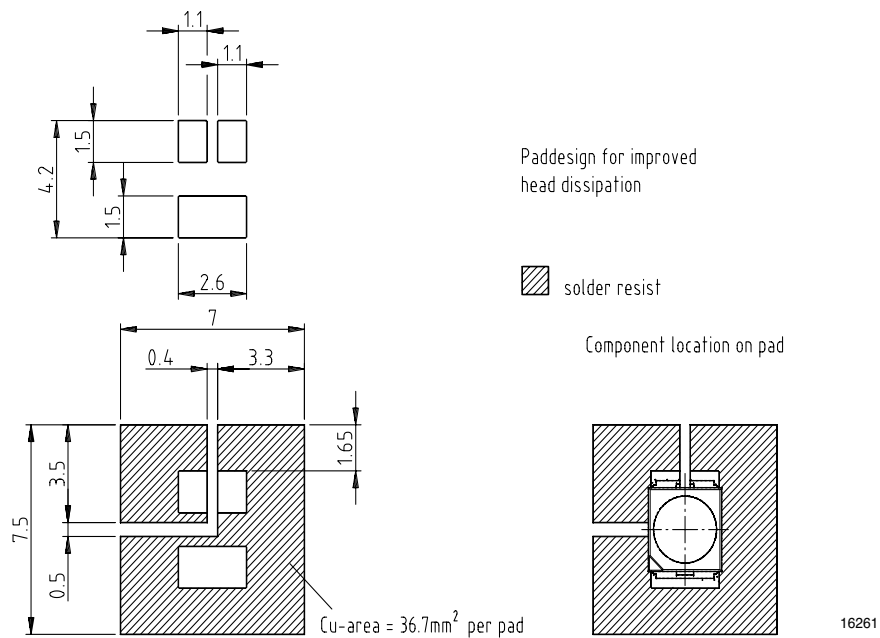

## Optional Pad Design

(Wave-Soldering),  $R_{thJA} = 290 \text{ K/W}$

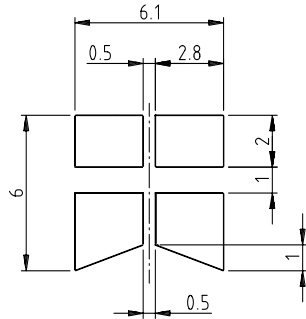

Optional pad design

solder resist

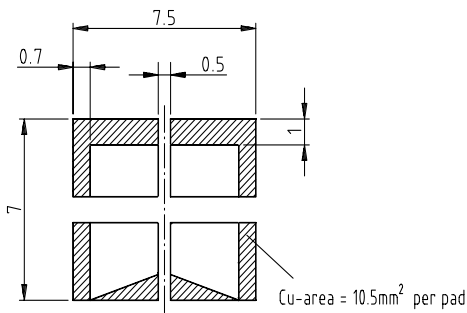

Component location on pad

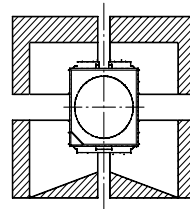

16262

## Optional Pad Design

(Reflow-Soldering),  $R_{thJA} = 290 \text{ K/W}$

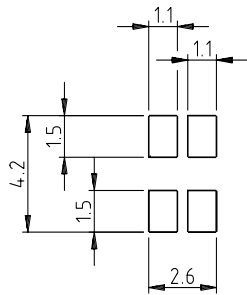

Optional pad design

solder resist

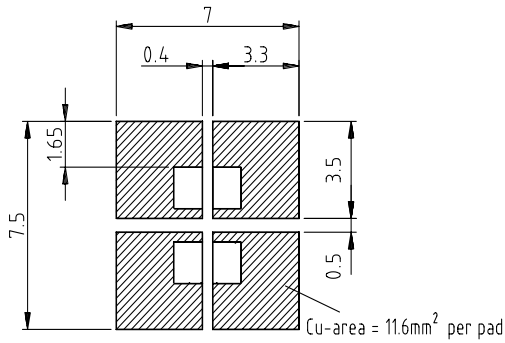

Component location on pad

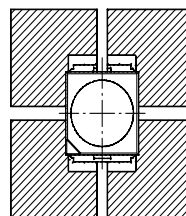

16263

## Package Dimensions in mm

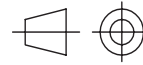
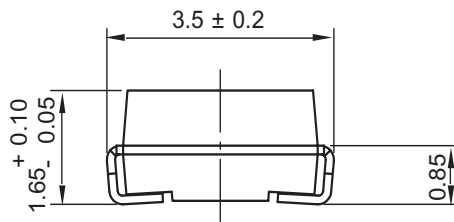

technical drawings  
according to DIN  
specifications

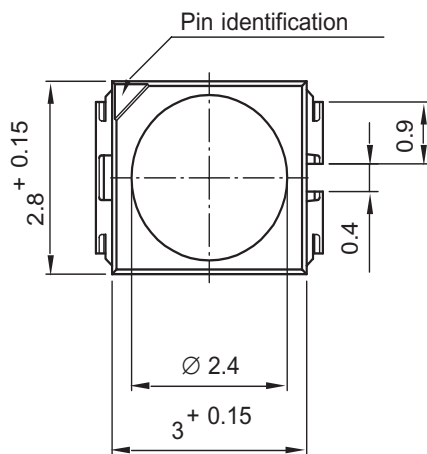

Drawing-No. : 6.541-5054.01-4  
Issue: 1; 19.02.04

## Mounting Pad Layout

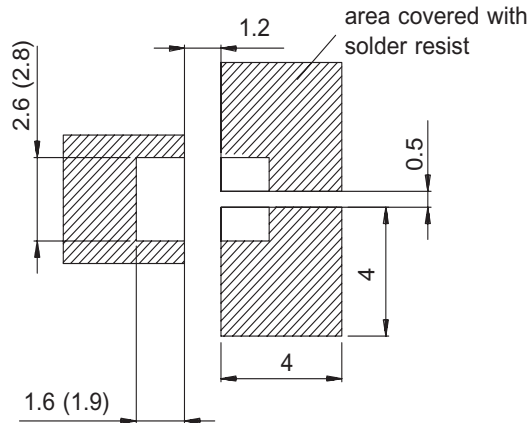

Dimensions: IR and Vaporphase  
(Wave Soldering)

16276

### Ozone Depleting Substances Policy Statement

It is the policy of **Vishay Semiconductor GmbH** to

1. Meet all present and future national and international statutory requirements.
2. Regularly and continuously improve the performance of our products, processes, distribution and operating systems with respect to their impact on the health and safety of our employees and the public, as well as their impact on the environment.

It is particular concern to control or eliminate releases of those substances into the atmosphere which are known as ozone depleting substances (ODSs).

The Montreal Protocol (1987) and its London Amendments (1990) intend to severely restrict the use of ODSs and forbid their use within the next ten years. Various national and international initiatives are pressing for an earlier ban on these substances.

**Vishay Semiconductor GmbH** has been able to use its policy of continuous improvements to eliminate the use of ODSs listed in the following documents.

1. Annex A, B and list of transitional substances of the Montreal Protocol and the London Amendments respectively
2. Class I and II ozone depleting substances in the Clean Air Act Amendments of 1990 by the Environmental Protection Agency (EPA) in the USA
3. Council Decision 88/540/EEC and 91/690/EEC Annex A, B and C (transitional substances) respectively.

**Vishay Semiconductor GmbH** can certify that our semiconductors are not manufactured with ozone depleting substances and do not contain such substances.

**We reserve the right to make changes to improve technical design  
and may do so without further notice.**

Parameters can vary in different applications. All operating parameters must be validated for each customer application by the customer. Should the buyer use Vishay Semiconductors products for any unintended or unauthorized application, the buyer shall indemnify Vishay Semiconductors against all claims, costs, damages, and expenses, arising out of, directly or indirectly, any claim of personal damage, injury or death associated with such unintended or unauthorized use.

Vishay Semiconductor GmbH, P.O.B. 3535, D-74025 Heilbronn, Germany  
Telephone: 49 (0)7131 67 2831, Fax number: 49 (0)7131 67 2423