



MiniSKiiP® CIB IPM

Three-phase bridge rectifier + brake chopper + three-phase inverter intelligent power module

SKiiP 26NABI066V3

Data sheet status: Preliminary

Features

- One screw assembly of driver, module and heat sink
- Solder-free assembly of power, control and auxiliary contacts
- Trench-Field-Stop IGBT
- Robust and soft freewheeling diodes in CAL technology
- Latch-up free SOI driver IC
- Advanced level shifter technology
- Bootstrap power supply technology
- Matched propagation delay for all channels
- Overcurrent shut-down via current sensing
- Interlock logic for shoot-through prevention
- Common shut-down signal
- Undervoltage lockout for all channels with hysteresis band
- Integrated temperature sensor (NTC)
- RoHS compliant

Typical Applications

- Industrial- & consumer drives
- Power supplies (SMPS & UPS)
- Industrial air conditioner

Remarks

Absolute Maximum Ratings (T _s =25°C, unless otherwise specified)				
Symbol	Parameter	Conditions	Values	Units
IGBT - Inverter, Chopper				
V _{CEs}			600	V
I _C	T _j = 175 °C	T _s = 25 °C	59	A
		T _s = 70 °C	47	A
I _{Cnom}			50	A
I _{CRM}	I _{CRM} = 2xI _{Cnom}		100	A
t _{psc}	V _{CC} = 360 V V _{GE} ≤ 15 V V _{CEs} ≤ 600 V	V _{DC} =360V, V _{GE} =15V, T _j =150°C	≤6	µs
T _{j(max)}			-40 ... +175	°C
Diode - Inverter, Chopper				
I _F	T _j = 175 °C	T _s = 25 °C	54	A
		T _s = 70 °C	42	A
I _{Fnom}			50	A
I _{FRM}	I _{FRM} = 2xI _{Fnom}		100	A
I _{FSM}	t _p = 10 ms, sin 180°, T _j = 25 °C		345 (320)	A
T _{j(max)}			-40 ... +175	°C
Diode - Rectifier				
V _{RRM}		T _j = 25°C	800	V
I _F		T _s = 70°C, T _j = 150°C	37	A
I _{FSM}		T _j = 25 °C, 10ms, half sine wave	370	A
T _{j(max)}			-40 ... +150	°C
Driver - Inverter, Chopper				
V _{CC}	Applied between VCC-VSS, VCCL-VSSL		17	V
V _{Bx}	Applied between VB1-U, VB2-V, VB3-W		17	V
V _{Sx}	Voltage to VSS, t _p < 500ns		-3 ... 600	V
V _{in}	Applied between HIN1, LIN1, HIN2, LIN2, HIN3, LIN3, LIN4, /ERRIN - VSS		VSS-0.3 ... VCC+0.3	V
V _{oErr}	Applied between /ERROUT-VSS		VSS-0.3 ... VCC+0.3	V
I _{max(EO)}	Between /ERROUT-VSS		10	mA
V _{ITRIP}	Applied between ITRIP-VSS		VSS-0.3 ... VCC+0.3	V
f _{max}			20	kHz
Temperature				
T _c			-40 ... +125	°C
T _{stg}			-40 ... +125	°C
System				
V _{CC}	Applied between P-NU, NV, NW		400	V
V _{CC(s)}	Applied between P-NU, NV, NW		≥400	V
V _{isol}	AC, rms, f=60Hz, t=1min, all pins to heat sink		2500	V
I _{RMS}	Per power terminal (20A / Spring)		20	A

Electrical Characteristics (T _s =25°C, unless otherwise specified)					
Symbol	Parameter	Conditions	Limits		Units
			min.	typ.	max.
IGBT - Inverter, Chopper					
V _{CEsat}	I _C = 50 A V _{GE} = 15 V	T _j = 25 °C	1.45	1.85	V
		T _j = 150 °C	1.65	2.05	V
V _{CEO}		T _j = 25 °C	0.9	1.1	V
		T _j = 150 °C	0.8	1.0	V
r _{CE}	V _{GE} = 15 V	T _j = 25 °C	11	15	mΩ
		T _j = 150 °C	17	21	mΩ
I _{CES}	V _{GE} = 0 V V _{CE} = 600 V	T _j = 25 °C		1	mA
E _{on}	V _{CC} =300V	T _j = 150 °C	3.0		mJ
E _{off}	I _C =50A	T _j = 150 °C	2.0		mJ
t _{d(on)}	R _{G on} / R _{G off} = 4.7 Ω	T _j = 150 °C	756		ns
t _r	di/dt _{on} = 648 A/µs	T _j = 150 °C	78		ns
t _{d(off)}	di/dt _{off} = 1271 A/µs	T _j = 150 °C	1276		ns
t _f		T _j = 150 °C	128		ns
R _{th(j-s)}	per IGBT		1.1		K/W
Diode - Inverter, Chopper					
V _F = V _{EC}	I _F = 50 A V _{GE} = 0 V (Chiplevel)	T _j = 25 °C	1.5	1.7	V
		T _j = 150 °C	1.5	1.7	V
V _{F0}		T _j = 25 °C	1.0	1.1	V
		T _j = 150 °C	0.9	1.0	V
r _F		T _j = 25 °C	10	12	mΩ
		T _j = 150 °C	12	14	mΩ
E _{rr}	I _F =50A	T _j = 150 °C	1.0		mJ
Q _{rr}	di _F /dt = -1771A/µs	T _j = 150 °C	2320		µC
IRRM	V _{CC} =300V, V _{GE} = 0 V	T _j = 150 °C	57		A
R _{th(j-s)D}	per diode		1.6		K/W

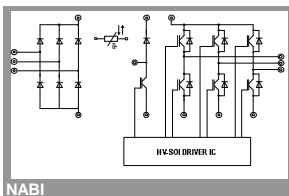

NABI

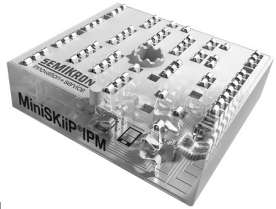

MiniSKiiP™ CIB IPM

Three-phase bridge rectifier + brake chopper + three-phase inverter intelligent power module

SKiiP 26NABI066V3

Data sheet status: Preliminary

Features

- One screw assembly of driver, module and heat sink
- Solder-free assembly of power, control and auxiliary contacts
- Trench-Field-Stop IGBT
- Robust and soft freewheeling diodes in CAL technology
- Latch-up free SOI driver IC
- Advanced level shifter technology
- Bootstrap power supply technology
- Matched propagation delay for all channels
- Overcurrent shut-down via current sensing
- Interlock logic for shoot-through prevention
- Common shut-down signal
- Undervoltage lockout for all channels with hysteresis band
- Integrated temperature sensor (NTC)
- RoHS compliant

Typical Applications

- Industrial- & consumer drives
- Power supplies (SMPS & UPS)
- Industrial air conditioner

Remarks

Electrical Characteristics (T _s =25°C, unless otherwise specified)			Limits			
Symbol	Parameter	Conditions	min.	typ.	max.	Units
Diode - Rectifier						
V _F	I _F = 15 A Chipplevel	T _j = 25 °C T _j = 125 °C		1.0 0.9	1.2 1.1	V
V _{F0}		T _j = 125°C		0.8		V
r _F		T _j = 125°C		13		mΩ
R _{th(j-s)}	per diode			1,7		K/W
Driver						
VCC	Applied between VCC-VSS, VCCL-VSSL			15		V
ICC	VCC=15V, all logic inputs=open, VCC-VSS				5,0	mA
VBx	Applied between VB1-U, VB2-V, VB3-W			15		V
IBx	VBx=15V, V _{IF} =V _{IL} =0V			300		μA
V _{IT+}	Applied between HIN1, HIN2, HIN3, LIN1, LIN2, LIN3, LIN4, /ERRIN - VSS			2,2	2,7	V
V _{IT-}	Applied between HIN1, HIN2, HIN3, LIN1, LIN2, LIN3, LIN4, /ERRIN - VSS		0,8	1,1		V
V _{oErr}	Error output voltage applied between /ERROUT-VSS				15	V
V _{UV}			10,3			V
V _{UVr}					12,1	V
t _{d,ITRIP}	ITRIP to output propagation delay			690		ns
t _{SIS}	Short pulse suppression for signal inputs			420		ns
t _{TD}	Interlock dead time			450		ns
f _{sw}				15	25	kHz
Temperature Sensor						
R ₁₀₀	T _{Sensor} = 100 °C (R ₂₅ = 5 kΩ)			339		Ω
B _{100/125}	R _(T) = R ₁₀₀ exp[B _{100/125} (1/T-1/373)]; [T] = K			4096		K
Module						
m					60	g
M _S			2		2,5	Nm

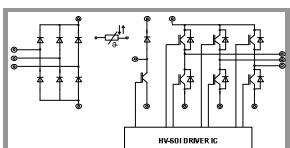

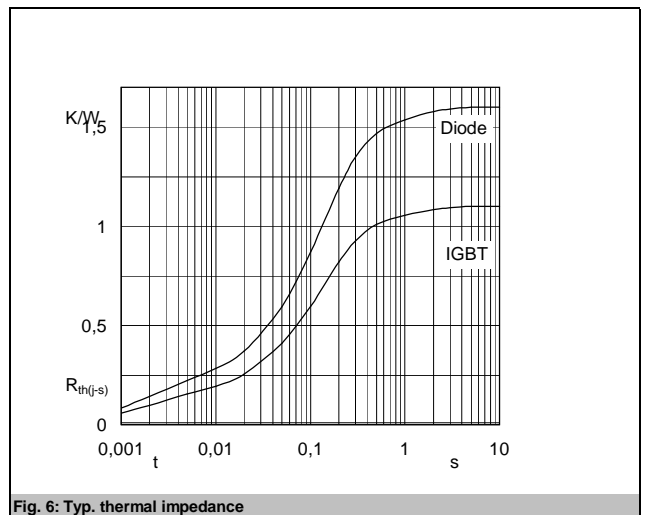
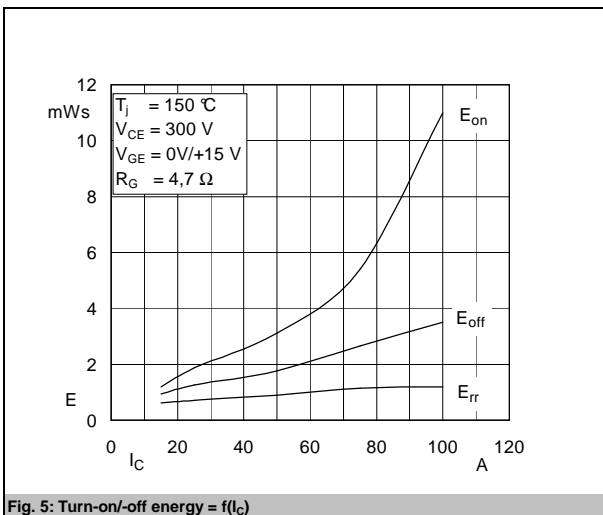
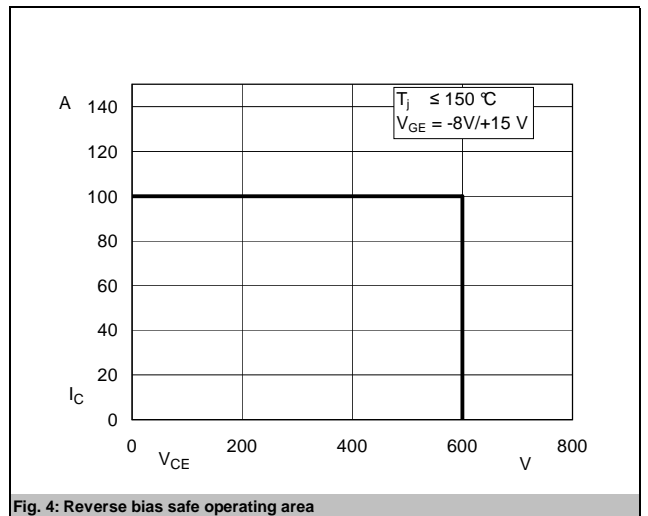
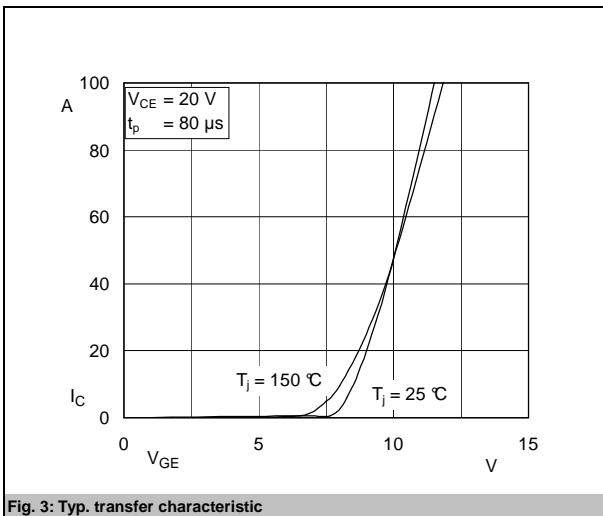
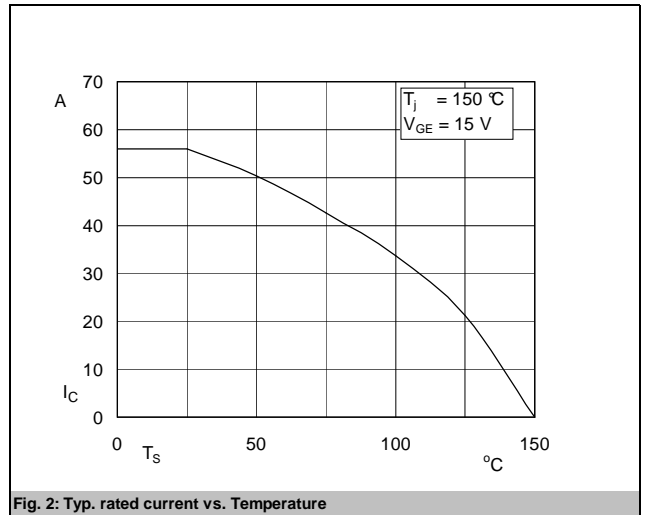
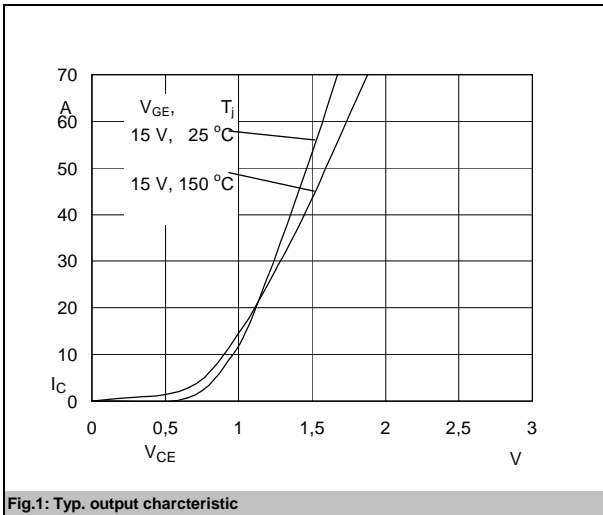

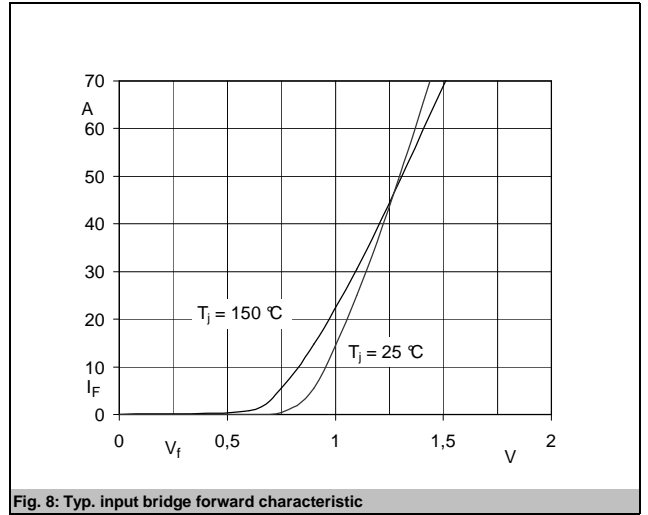
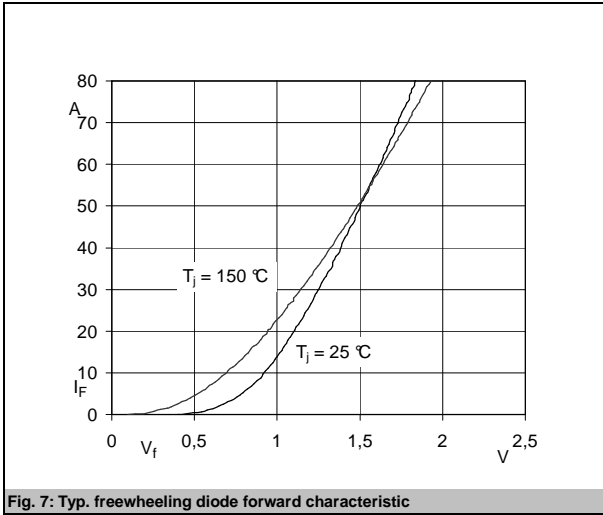

Pin Number	Pin Name	Pin Description
1	HIN1	PWM signal input for U phase high side switch
2	HIN2	PWM signal input for V phase high side switch
3	HIN3	PWM signal input for W phase high side switch
4	LIN1	PWM signal input for U phase low side switch
5	LIN2	PWM signal input for V phase low side switch
6	LIN3	PWM signal input for W phase low side switch
7	/ERROUT	Error logic output (inverted)
8	/ERRIN	External error / shut-down logic input (inverted)
9	ITRIP	Comparator input for current measurement
10	LIN4	PWM signal input for brake chopper switch
11	VSS	Driver IC supply voltage ground
12	VCC	Driver IC main supply voltage
13	VB2	Floating supply for V phase high side IGBT
14	VB1	Floating supply for U phase high side IGBT
15	VB3	Floating supply for W phase high side IGBT
16	VSSL	Low side supply voltage ground
17	VCCL	Low side supply voltage
L1	L1	Bridge rectifier input for phase 1
L2	L2	Bridge rectifier input for phase 2
L3	L3	Bridge rectifier input for phase 3
	U/E1	U phase output
	V/E3	V phase output
	W/E5	W phase output
	NU/E2	Negative DC-Link input for U phase
	NV/E4	Negative DC-Link input for V phase
	NW/E6	Negative DC-Link input for W phase
	B	Brake chopper B terminal
	+B	Brake chopper +B terminal
	-B/E8	Brake chopper -B terminal
	P	Positive DC-Link input
	+RECT	Bridge rectifier output for positive DC-Link
	-RECT	Bridge rectifier output for negative DC-Link
	+T	Temperature sensor terminal (+)
	-T	Temperature sensor terminal (-)

Fig. 4: PIN Description

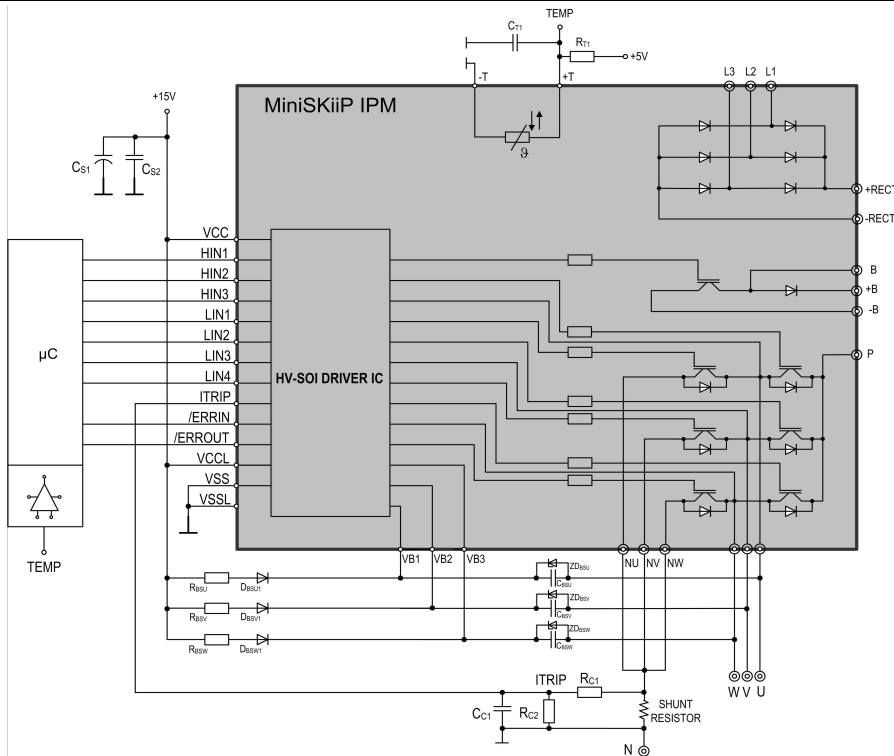

Fig. 5: Internal Circuit and Typ. Application

