

PNP Silicon

Features

- We declare that the material of product compliance with RoHS requirements.
Pb-Free package is available
 RoHS product for packing code suffix "G"
 Halogen free product for packing code suffix "H"

ORDERING INFORMATION

Device	Package	Shipping
2SA1037AKxLT1	SOT-23	3000/Tape & Reel



MAXIMUM RATINGS

Rating	Symbol	Value	Unit
Collector-Emitter Voltage	V_{CEO}	-50	V
Collector-Base Voltage	V_{CBO}	-60	V
Emitter-Base Voltage	V_{EBO}	-6.0	V
Collector Current — Continuous	I_C	-150	mAdc
Collector power dissipation	P_C	0.2	W
Junction temperature	T_j	150	°C
Storage temperature	T_{stg}	-55 ~ +150	°C

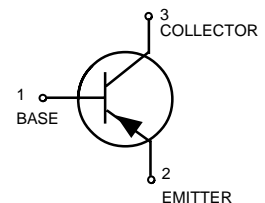

DEVICE MARKING

2SA1037AKxLT1 = FQ	2SA1037AKxLT1 = G3F	2SA1037AKxLT1 = FR
--------------------	---------------------	--------------------

ELECTRICAL CHARACTERISTICS ($T_A = 25^\circ\text{C}$ unless otherwise noted.)

Characteristic	Symbol	Min	Typ	Max	Unit
Collector-Emitter Breakdown Voltage ($I_C = -1\text{ mA}$)	$V_{(BR)CEO}$	-50	—	—	V
Emitter-Base Breakdown Voltage ($I_E = -50\ \mu\text{A}$)	$V_{(BR)EBO}$	-6	—	—	V
Collector-Base Breakdown Voltage ($I_C = -50\ \mu\text{A}$)	$V_{(BR)CBO}$	-60	—	—	V
Collector Cutoff Current ($V_{CB} = -60\text{ V}$)	I_{CBO}	—	—	-0.1	μA
Emitter cutoff current ($V_{EB} = -6\text{ V}$)	I_{EBO}	—	—	-0.1	μA
Collector-emitter saturation voltage ($I_C / I_B = -50\text{ mA} / -5\text{ mA}$)	$V_{CE(sat)}$	—	—	-0.5	V
DC current transfer ratio ($V_{CE} = -6\text{ V}, I_C = -1\text{ mA}$)	h_{FE}	120	—	560	—
Transition frequency ($V_{CE} = -12\text{ V}, I_E = 2\text{ mA}, f = 30\text{ MHz}$)	f_T	—	140	—	MHz
Output capacitance ($V_{CB} = -12\text{ V}, I_E = 0\text{ A}, f = 1\text{ MHz}$)	C_{ob}	—	4.0	5.0	pF

h_{FE} values are classified as follows:

*	Q	R	S
h_{FE}	120-270	180-390	270-560

Fig.1 Grounded emitter propagation characteristics

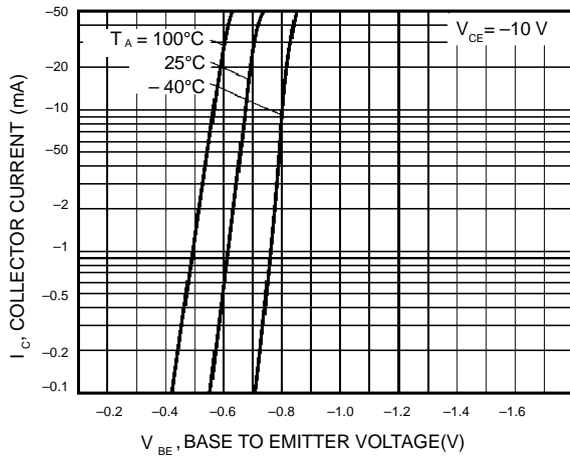

Fig.2 Grounded emitter output characteristics(I)

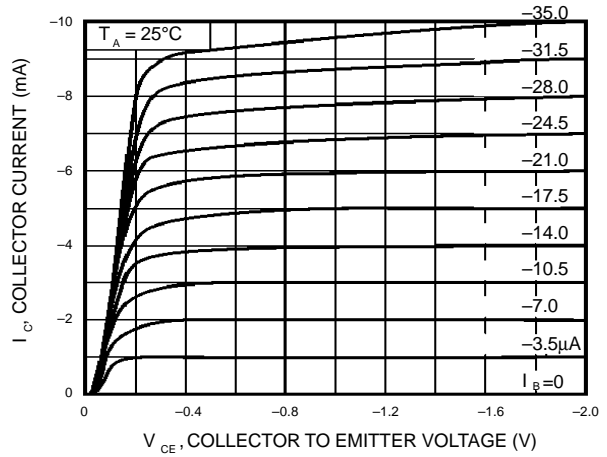

Fig.3 Grounded emitter output characteristics(II)

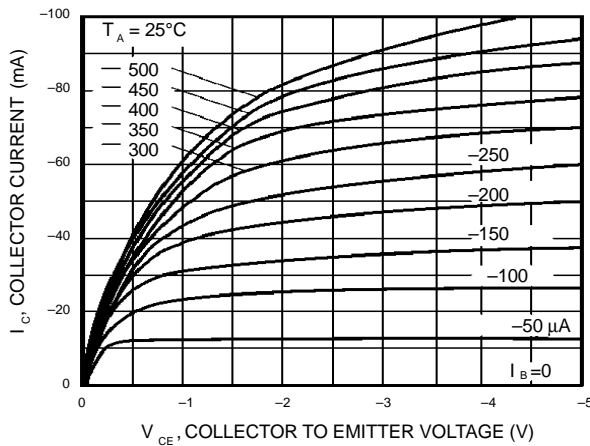

Fig.4 DC current gain vs. collector current (I)

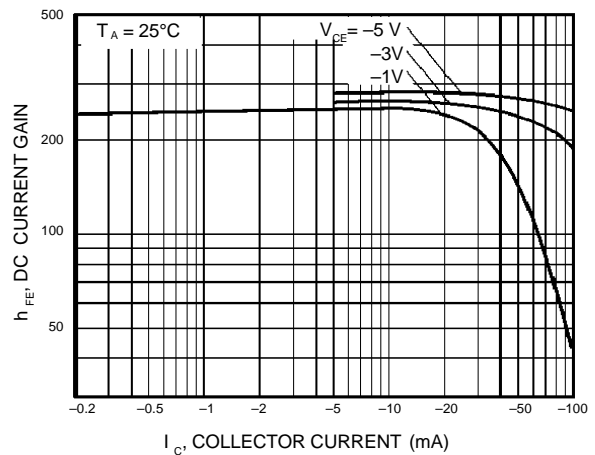

Fig.5 DC current gain vs. collector current (II)

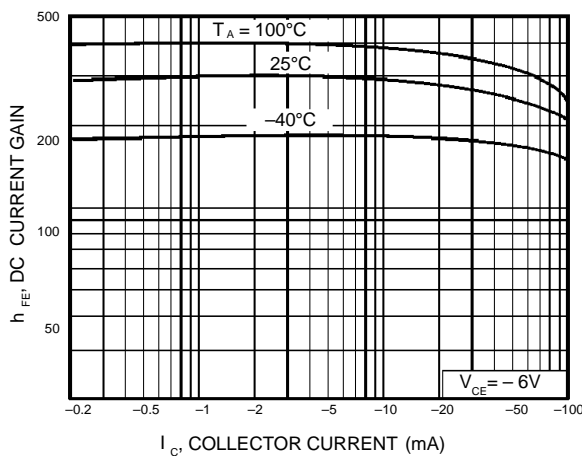

Fig.6 Collector-emitter saturation voltage vs. collector current (I)

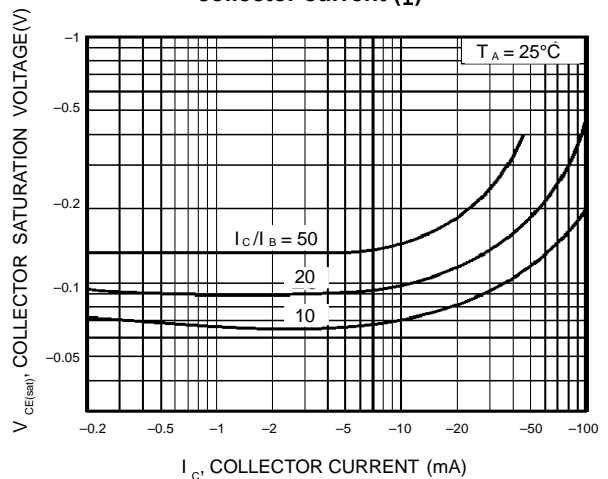

Fig.7 Collector-emitter saturation voltage vs. collector current (I)

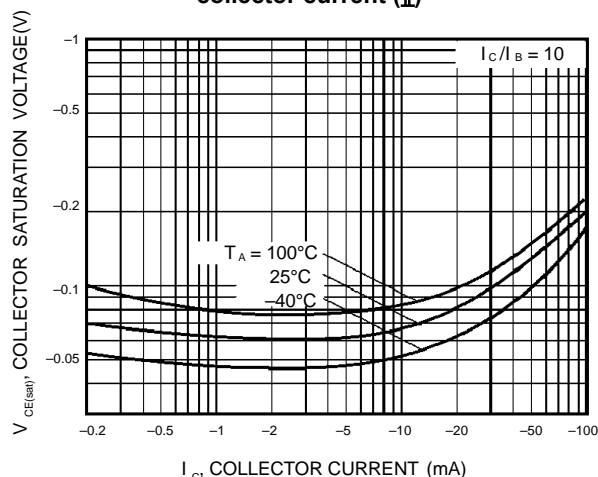
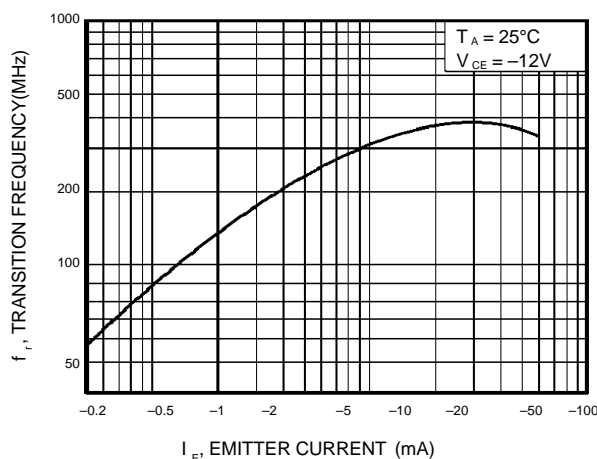
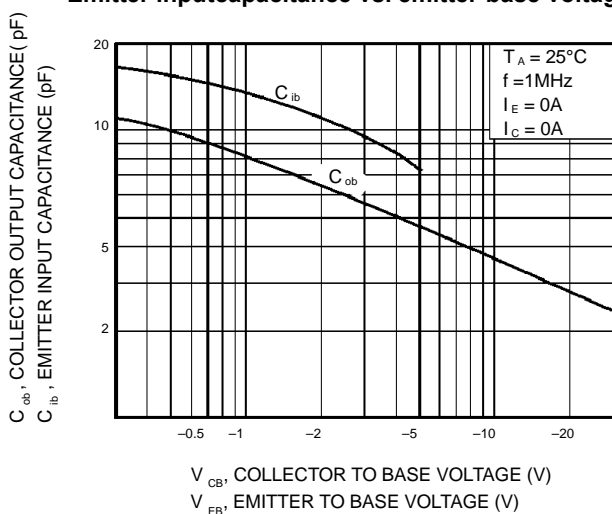

Fig.8 Gain bandwidth product vs. emitter current



**Fig.9 Collector output capacitance vs. collector-base voltage
Emitter input capacitance vs. emitter-base voltage**



SOT-23

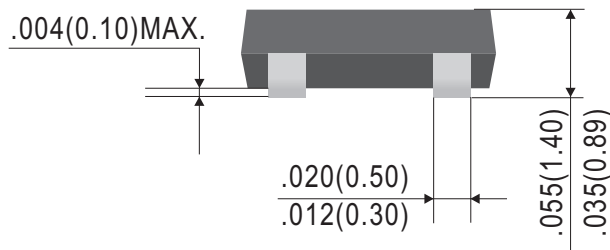
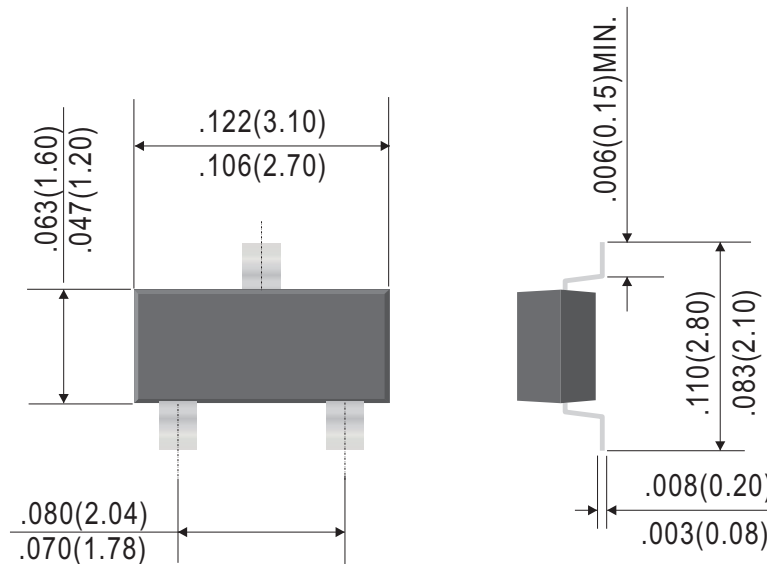

Dimensions in inches and (millimeters)

