

PLEASE CHECK WWW.MOLEX.COM FOR LATEST PART INFORMATION

Part Number: **0878351043**
Status: **Active**
Overview: [cgrid_sl_products](#)
Description: 2.54mm (.100") Pitch C-Grid® Header, Right Angle, Through Hole, Dual Row, Low Profile, Shrouded, 10 Circuits, 0.38µm (15µ") Gold (Au) Selective Plating, Center Polarization Slot, with Two End Slots, Kinked PC Tails, Lead-free

Documents:

[3D Model](#) [Product Specification PS-70246-100 \(PDF\)](#)
[Drawing \(PDF\)](#) [RoHS Certificate of Compliance \(PDF\)](#)

General

Product Family	PCB Headers
Series	87835
Application	Wire-to-Board
Comments	Kinking at First and Last Pin of Inner Row
Overview	cgrid_sl_products
Product Name	C-Grid®

Physical

Breakaway	No
Circuits (Loaded)	10
Circuits (maximum)	10
Color - Resin	Natural
Durability (mating cycles max)	50
First Mate / Last Break	No
Glow-Wire Compliant	No
Guide to Mating Part	No
Keying to Mating Part	None
Lock to Mating Part	Yes
Material - Plating Mating	Gold
Material - Plating Termination	Tin
Material - Resin	Nylon
Number of Rows	2
Orientation	Right Angle
PC Tail Length (in)	0.125 In
PC Tail Length (mm)	3.18 mm
PCB Locator	No
PCB Retention	None
PCB Thickness Recommended (in)	0.062 In
PCB Thickness Recommended (mm)	1.60 mm
Packaging Type	Tray
Pitch - Mating Interface (in)	0.100 In
Pitch - Mating Interface (mm)	2.54 mm
Plating min: Mating (µin)	15.2
Plating min: Mating (µm)	0.38
Plating min: Termination (µin)	100
Plating min: Termination (µm)	2.5
Polarized to Mating Part	Center Slot
Polarized to PCB	No
Shrouded	Fully
Stackable	No
Surface Mount Compatible (SMC)	Yes
Temperature Range - Operating	-55°C to +120°C
Termination Interface: Style	Through Hole

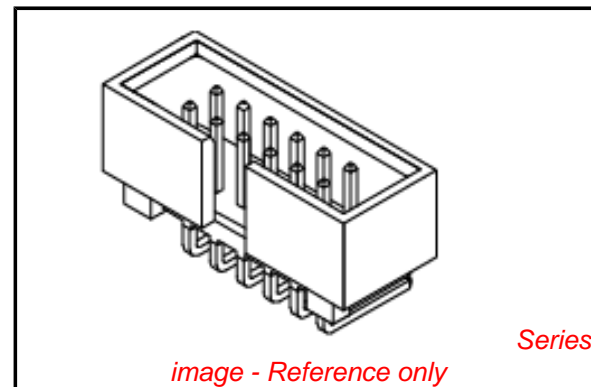

EU RoHS

ELV and RoHS Compliant
REACH SVHC Contains SVHC: No
Halogen-Free Status

China RoHS



Not Halogen-Free
Need more information on product environmental compliance?

Email productcompliance@molex.com
 For a multiple part number RoHS Certificate of Compliance, [click here](#)

Please visit the [Contact Us](#) section for any non-product compliance questions.

Search Parts in this Series

[87835Series](#)

Mates With

.050" pitch ribbon cable connectors

Electrical

Current - Maximum per Contact	2.5A
Voltage - Maximum	250V

Solder Process Data

Duration at Max. Process Temperature (seconds)	5
Lead-free Process Capability	Wave Capable (TH only)
Max. Cycles at Max. Process Temperature	1
Process Temperature max. C	265

Material Info**Reference - Drawing Numbers**

Packaging Specification	PK-87835-001
Product Specification	PS-70246-100
Sales Drawing	SD-87835-004

This document was generated on 05/25/2010

PLEASE CHECK WWW.MOLEX.COM FOR LATEST PART INFORMATION

10 9 8 7 6 5 4 3 2 1

F

E

D

C

B

A

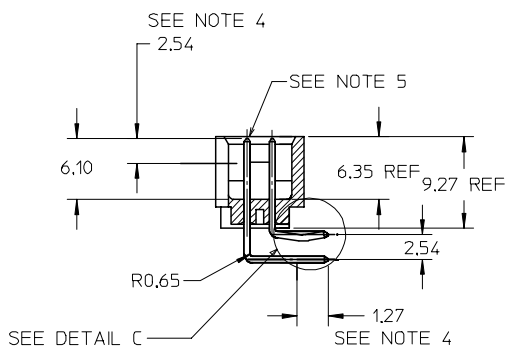
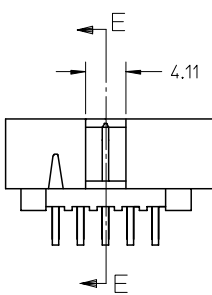
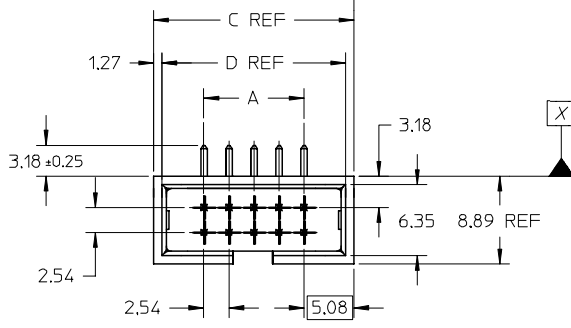

SECTION E-E

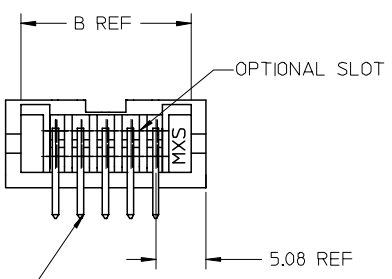

ASSEMBLY PART	CKT SIZE	A	B	C	D
87835-1043	10	10.16	17.27	20.32	17.78
87835-1643	16	17.78	24.89	27.94	25.40
87835-2043	20	22.86	29.97	33.02	30.48
87835-4043	40	48.26	55.37	58.42	55.88
87835-5043	50	60.96	68.07	71.12	68.58

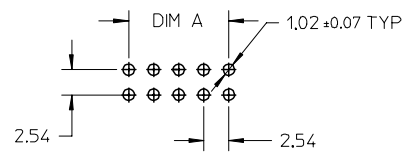

RECOMMENDED PCB PATTERN

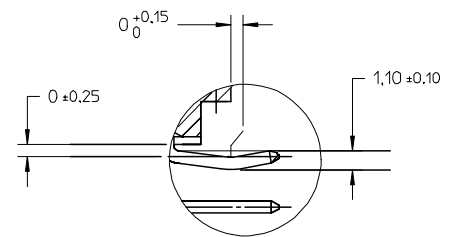

DETAIL C

NOTES:

- PIN PUSHOUT FORCE 0.91KG MIN.
- PRODUCT SPEC; PS-70246 APPLIES.
- WAFER TO BE FLAT WITHIN 0.03MM/CM
- MEASURE POINT FOR PLATING THICKNESS
- GOLD END OF PIN UNLESS OVERALL PLATED.
- FINISH : (PER E5-88) (ALL WITH 1.27um MIN NICKEL UNDERPLATE OVERALL.)
0.38um MIN AU & 2.54um MIN TIN IN SELECTED AREAS.
- KINKING IS AT FIRST AND LAST PIN OF INNER ROW.

EC NO: S2004-0277 DRWN:RSHAN 2003/11/27 CHKD:KCLING 2003/12/01 APPR:SKTOH 2003/12/01	QUALITY SYMBOLS ▽ = 0 ∇ = 0	GENERAL TOLERANCES (UNLESS SPECIFIED)		SCALE NTS	DESIGN UNITS METRIC	THIRD ANGLE PROJECTION	REVISE ON CAD ONLY	
		4 PLACES ± --- ± ---	3 PLACES ± --- ± ---	DIMENSION STYLE MM ONLY		TITLE		
		2 PLACES ± 0.20 ± ---	1 PLACE ± --- ± ---	DRAWN BY RSHAN	DATE 2003/11/14	C-GRID, R/A, SHROUDED HEADER WITH 2 END SLOTS MOLEX INCORPORATED		
		ANGULAR ± 3 °		CHECKED BY KCLING	DATE 2003/11/19			
DRAFT WHERE APPLICABLE MUST REMAIN WITHIN DIMENSIONS		APPROVED BY SKTOH	DATE 2003/11/26	MATERIAL NO. SEE TABLE	DOCUMENT NO. SD-87835-004	SHEET NO. 1 OF 1	A3	

9 8 7 6 5 4 3 2 1