

**RADIATION HARDENED  
 POWER MOSFET  
 THRU-HOLE (TO-39)**

**IRHF57Z30  
 30V, N-CHANNEL  
 R5 TECHNOLOGY**

**Product Summary**

Part Number	Radiation Level	RDS(on)	ID
IRHF57Z30	100K Rads (Si)	0.045Ω	12A*
IRHF53Z30	300K Rads (Si)	0.045Ω	12A*
IRHF54Z30	600K Rads (Si)	0.045Ω	12A*
IRHF58Z30	1000K Rads (Si)	0.056Ω	12A*



International Rectifier's R5™ technology provides high performance power MOSFETs for space applications. These devices have been characterized for Single Event Effects (SEE) with useful performance up to an LET of 80 (MeV/(mg/cm<sup>2</sup>)). The combination of low RDS(on) and low gate charge reduces the power losses in switching applications such as DC to DC converters and motor control. These devices retain all of the well established advantages of MOSFETs such as voltage control, fast switching, ease of paralleling and temperature stability of electrical parameters.

**Features:**

- Single Event Effect (SEE) Hardened
- Ultra Low RDS(on)
- Neutron Tolerant
- Identical Pre and Post Electrical Test Conditions
- Repetitive Avalanche Ratings
- Dynamic dv/dt Ratings
- Simple Drive Requirements
- Ease of Paralleling
- Hermetically Sealed
- Electrically Isolated

**Absolute Maximum Ratings**

**Pre-Irradiation**

	Parameter		Units
ID @ VGS = 12V, TC = 25°C	Continuous Drain Current	12*	A
ID @ VGS = 12V, TC = 100°C	Continuous Drain Current	10	
IDM	Pulsed Drain Current ①	48	
PD @ TC = 25°C	Max. Power Dissipation	25	W
	Linear Derating Factor	0.2	W/°C
VGS	Gate-to-Source Voltage	±20	V
EAS	Single Pulse Avalanche Energy ②	520	mJ
IAR	Avalanche Current ①	12	A
EAR	Repetitive Avalanche Energy ①	2.5	mJ
dv/dt	Peak Diode Recovery dv/dt ③	3.0	V/ns
TJ	Operating Junction	-55 to 150	°C
TSTG	Storage Temperature Range		
	Lead Temperature	300 ( 0.063 in./1.6mm from case for 10s)	
	Weight	0.98 (Typical)	g

\* Current is limited by internal wire diameter  
 For footnotes refer to the last page

**Electrical Characteristics @ T<sub>j</sub> = 25°C (Unless Otherwise Specified)**

	Parameter	Min	Typ	Max	Units	Test Conditions
BV <sub>DSS</sub>	Drain-to-Source Breakdown Voltage	30	—	—	V	V <sub>GS</sub> = 0V, I <sub>D</sub> = 1.0mA
ΔBV <sub>DSS</sub> /ΔT <sub>J</sub>	Temperature Coefficient of Breakdown Voltage	—	0.03	—	V/°C	Reference to 25°C, I <sub>D</sub> = 1.0mA
R <sub>DS(on)</sub>	Static Drain-to-Source On-State Resistance	—	—	0.045	Ω	V <sub>GS</sub> = 12V, I <sub>D</sub> = 10A ④
V <sub>GS(th)</sub>	Gate Threshold Voltage	2.0	—	4.0	V	V <sub>DS</sub> = V <sub>GS</sub> , I <sub>D</sub> = 1.0mA
g <sub>fs</sub>	Forward Transconductance	12	—	—	S (Ω)	V <sub>DS</sub> > 15V, I <sub>DS</sub> = 10A ④
I <sub>DSS</sub>	Zero Gate Voltage Drain Current	—	—	10	μA	V <sub>DS</sub> = 24V, V <sub>GS</sub> = 0V
		—	—	25		V <sub>DS</sub> = 24V, V <sub>GS</sub> = 0V, T <sub>J</sub> = 125°C
I <sub>GSS</sub>	Gate-to-Source Leakage Forward	—	—	100	nA	V <sub>GS</sub> = 20V
I <sub>GSS</sub>	Gate-to-Source Leakage Reverse	—	—	-100		V <sub>GS</sub> = -20V
Q <sub>g</sub>	Total Gate Charge	—	—	65	nC	V <sub>GS</sub> = 12V, I <sub>D</sub> = 12A
Q <sub>gs</sub>	Gate-to-Source Charge	—	—	20		V <sub>DS</sub> = 15V
Q <sub>gd</sub>	Gate-to-Drain ('Miller') Charge	—	—	10		
t <sub>d(on)</sub>	Turn-On Delay Time	—	—	25	ns	V <sub>DD</sub> = 15V, I <sub>D</sub> = 12A V <sub>GS</sub> = 12V, R <sub>G</sub> = 7.5Ω
t <sub>r</sub>	Rise Time	—	—	100		
t <sub>d(off)</sub>	Turn-Off Delay Time	—	—	35		
t <sub>f</sub>	Fall Time	—	—	30		
L <sub>S</sub> + L <sub>D</sub>	Total Inductance	—	7.0	—	nH	Measured from Drain lead (6mm /0.25in. from package) to Source lead (6mm /0.25in. from package) with Source wires internally bonded from Source Pin to Drain Pad
C <sub>iss</sub>	Input Capacitance	—	2055	—	pF	V <sub>GS</sub> = 0V, V <sub>DS</sub> = 25V f = 1.0MHz
C <sub>oss</sub>	Output Capacitance	—	936	—		
C <sub>rss</sub>	Reverse Transfer Capacitance	—	35	—		

**Source-Drain Diode Ratings and Characteristics**

	Parameter	Min	Typ	Max	Units	Test Conditions
I <sub>S</sub>	Continuous Source Current (Body Diode)	—	—	12*	A	
I <sub>SM</sub>	Pulse Source Current (Body Diode) ①	—	—	48		
V <sub>SD</sub>	Diode Forward Voltage	—	—	1.5	V	T <sub>j</sub> = 25°C, I <sub>S</sub> = 12A, V <sub>GS</sub> = 0V ④
t <sub>rr</sub>	Reverse Recovery Time	—	—	92	ns	T <sub>j</sub> = 25°C, I <sub>F</sub> = 12A, di/dt ≤ 100A/μs
Q <sub>RR</sub>	Reverse Recovery Charge	—	—	194	nC	V <sub>DD</sub> ≤ 25V ④
t <sub>on</sub>	Forward Turn-On Time	Intrinsic turn-on time is negligible. Turn-on speed is substantially controlled by L <sub>S</sub> + L <sub>D</sub> .				

\* Current is limited by internal wire diameter

**Thermal Resistance**

	Parameter	Min	Typ	Max	Units	Test Conditions
R <sub>thJC</sub>	Junction-to-Case	—	—	5.0	°C/W	Typical socket mount
R <sub>thJA</sub>	Junction-to-Ambient	—	—	175		

**Note:** Corresponding Spice and Saber models are available on the G&S Website.

For footnotes refer to the last page

## Radiation Characteristics

IRHF57Z30

International Rectifier Radiation Hardened MOSFETs are tested to verify their radiation hardness capability. The hardness assurance program at International Rectifier is comprised of two radiation environments. Every manufacturing lot is tested for total ionizing dose (per notes 5 and 6) using the TO-3 package. Both pre- and post-irradiation performance are tested and specified using the same drive circuitry and test conditions in order to provide a direct comparison.

**Table 1. Electrical Characteristics @ Tj = 25°C, Post Total Dose Irradiation** ⑤⑥

	Parameter	Up to 600K Rads(Si) <sup>1</sup>		1000K Rads (Si) <sup>2</sup>		Units	Test Conditions
		Min	Max	Min	Max		
BV <sub>DSS</sub>	Drain-to-Source Breakdown Voltage	30	—	30	—	V	V <sub>GS</sub> = 0V, I <sub>D</sub> = 1.0mA
V <sub>GS(th)</sub>	Gate Threshold Voltage	2.0	4.0	1.5	4.0		V <sub>GS</sub> = V <sub>DS</sub> , I <sub>D</sub> = 1.0mA
I <sub>GSS</sub>	Gate-to-Source Leakage Forward	—	100	—	100	nA	V <sub>GS</sub> = 20V
I <sub>GSS</sub>	Gate-to-Source Leakage Reverse	—	-100	—	-100		V <sub>GS</sub> = -20 V
I <sub>DSS</sub>	Zero Gate Voltage Drain Current	—	10	—	25	μA	V <sub>DS</sub> = 24V, V <sub>GS</sub> = 0V
R <sub>DS(on)</sub>	Static Drain-to-Source ④ On-State Resistance (TO-3)	—	0.024	—	0.03	Ω	V <sub>GS</sub> = 12V, I <sub>D</sub> = 10A
R <sub>DS(on)</sub>	Static Drain-to-Source ④ On-State Resistance (TO-39)	—	0.045	—	0.056	Ω	V <sub>GS</sub> = 12V, I <sub>D</sub> = 10A
V <sub>SD</sub>	Diode Forward Voltage ④	—	1.5	—	1.5	V	V <sub>GS</sub> = 0V, I <sub>S</sub> = 12A

1. Part numbers IRHF57Z30, IRHF53Z30 and IRHF54Z30

2. Part number IRHF58Z30

International Rectifier radiation hardened MOSFETs have been characterized in heavy ion environment for Single Event Effects (SEE). Single Event Effects characterization is illustrated in Fig. a and Table 2.

**Table 2. Single Event Effect Safe Operating Area**

Ion	LET (MeV/(mg/cm <sup>2</sup> ))	Energy (MeV)	Range (μm)	V <sub>DS</sub> (V)				
				@ V <sub>GS</sub> = 0V	@ V <sub>GS</sub> = -5V	@ V <sub>GS</sub> = -10V	@ V <sub>GS</sub> = -15V	@ V <sub>GS</sub> = -20V
Br	37.9	255	33.4	30	30	30	25	20
I	59.4	290	28.8	25	25	20	15	10
Au	80.3	313	26.5	22.5	22.5	15	10	—

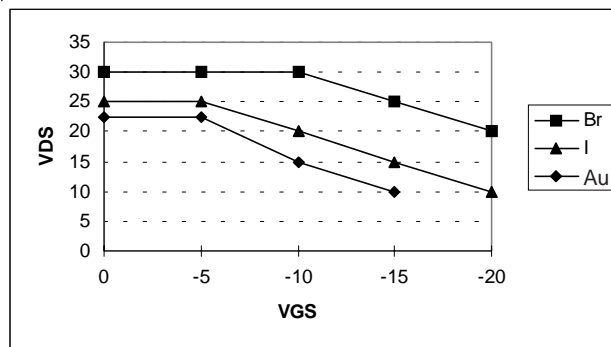

**Fig a. Single Event Effect, Safe Operating Area**

For footnotes refer to the last page

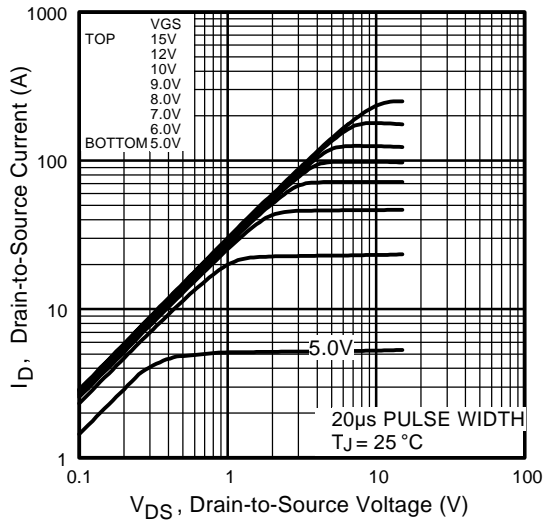

Fig 1. Typical Output Characteristics

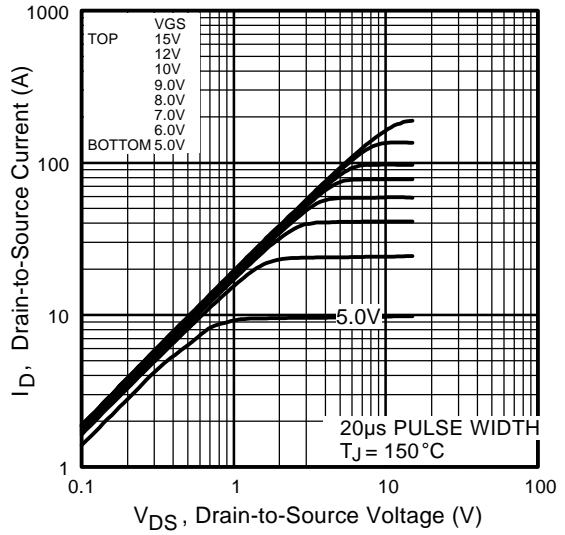

Fig 2. Typical Output Characteristics

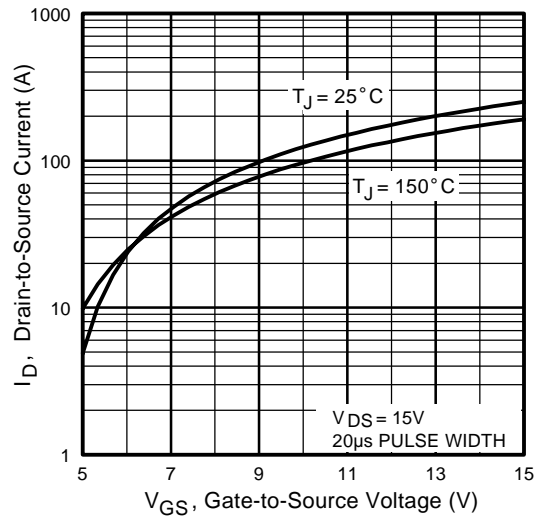

Fig 3. Typical Transfer Characteristics

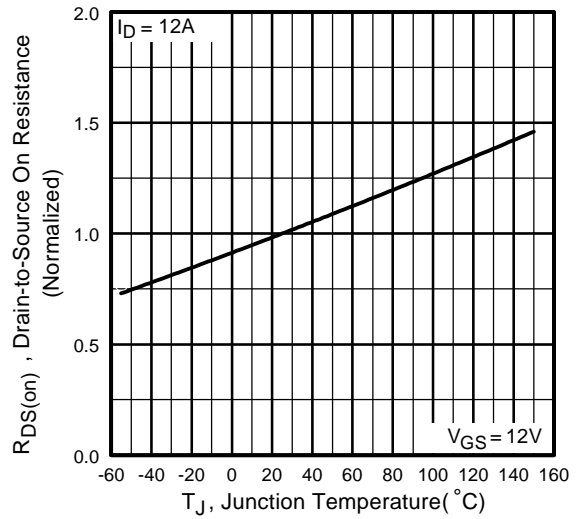

Fig 4. Normalized On-Resistance Vs. Temperature

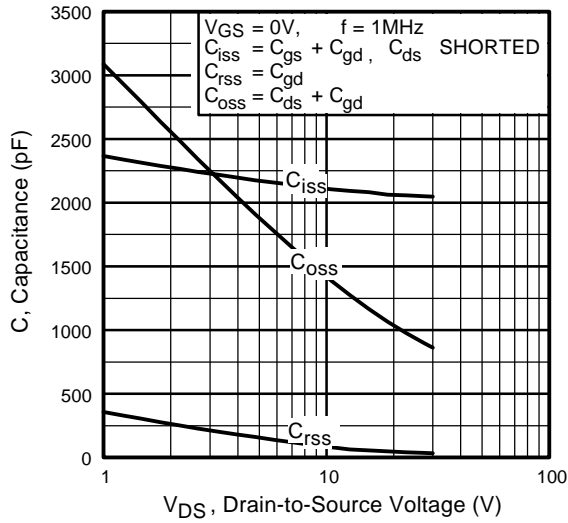

Fig 5. Typical Capacitance Vs. Drain-to-Source Voltage

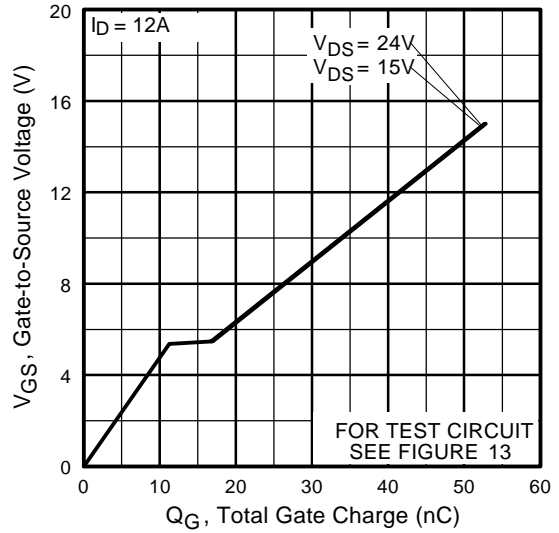

Fig 6. Typical Gate Charge Vs. Gate-to-Source Voltage

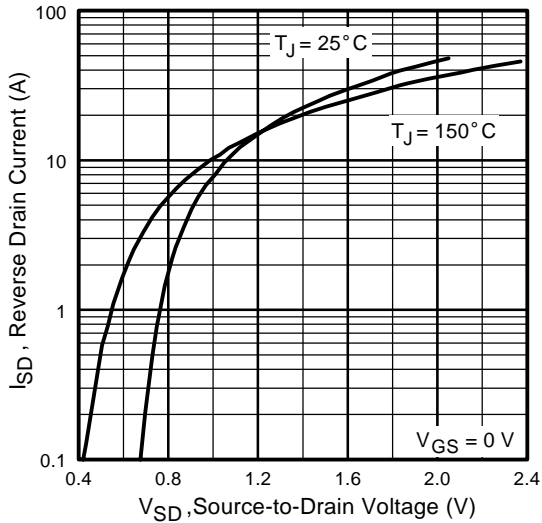

Fig 7. Typical Source-Drain Diode Forward Voltage

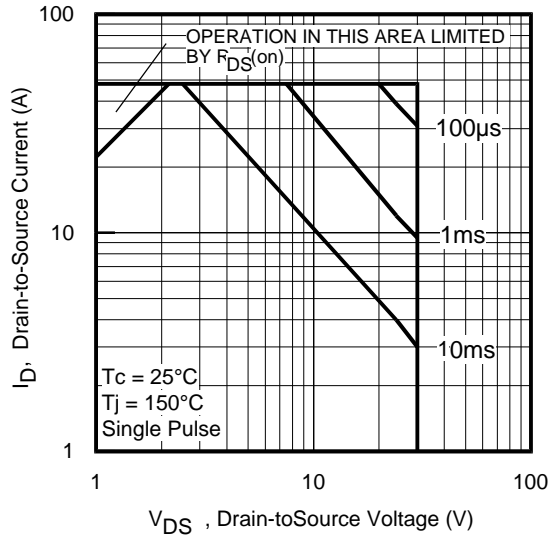

Fig 8. Maximum Safe Operating Area

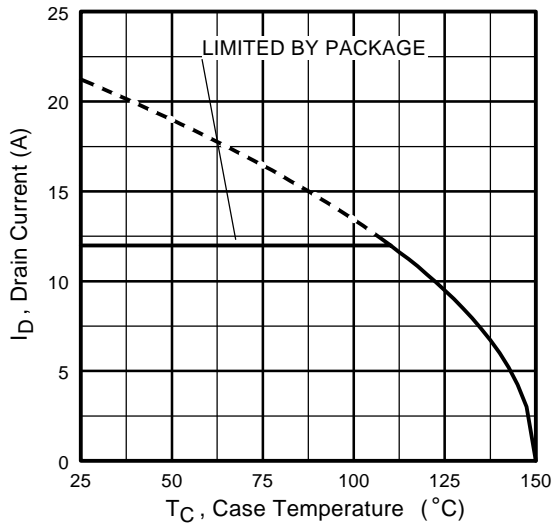

Fig 9. Maximum Drain Current Vs. Case Temperature

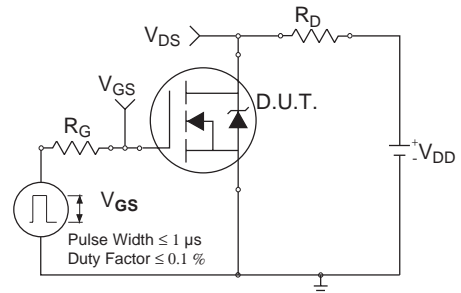

Fig 10a. Switching Time Test Circuit

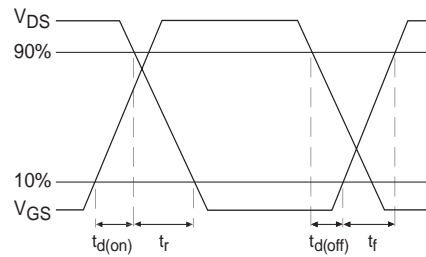

Fig 10b. Switching Time Waveforms

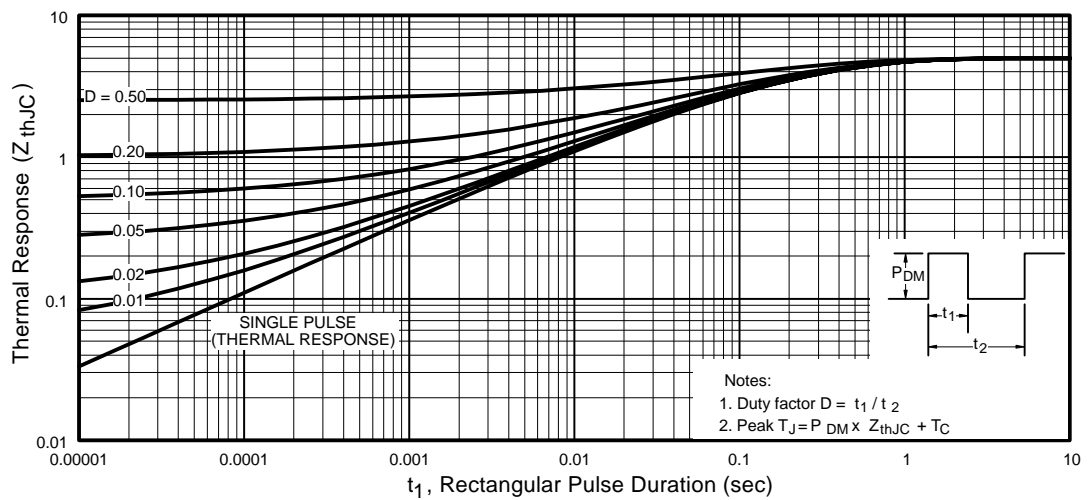

Fig 11. Maximum Effective Transient Thermal Impedance, Junction-to-Case

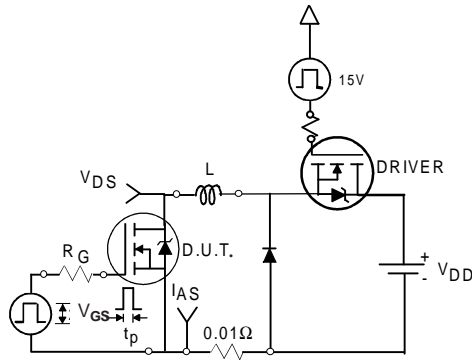

Fig 12a. Unclamped Inductive Test Circuit

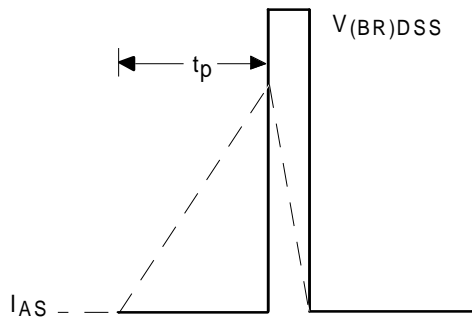

Fig 12b. Unclamped Inductive Waveforms

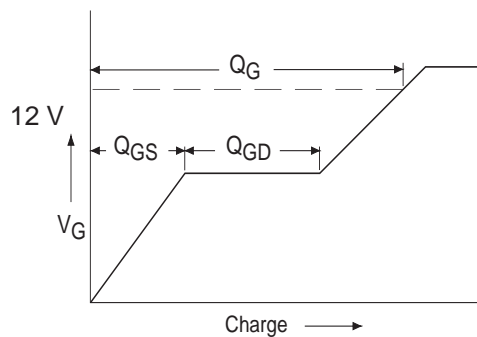

Fig 13a. Basic Gate Charge Waveform

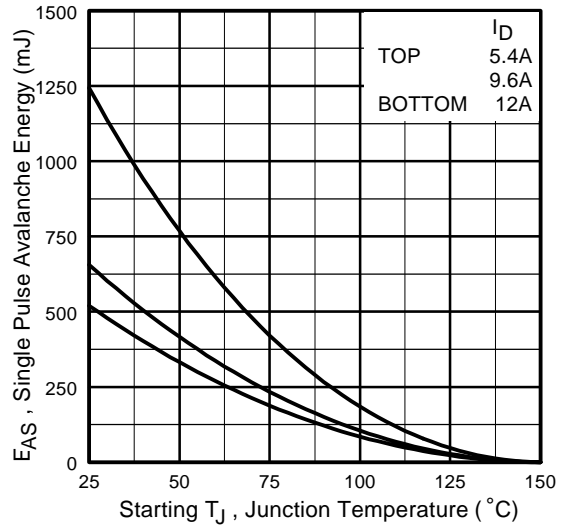

Fig 12c. Maximum Avalanche Energy Vs. Drain Current

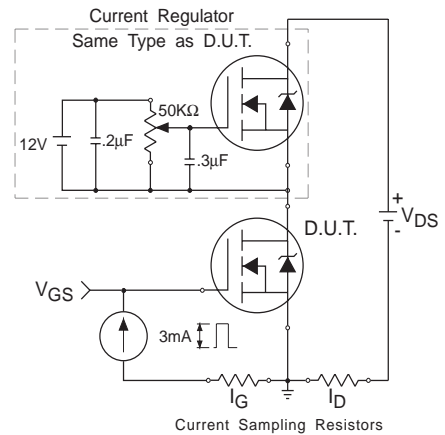
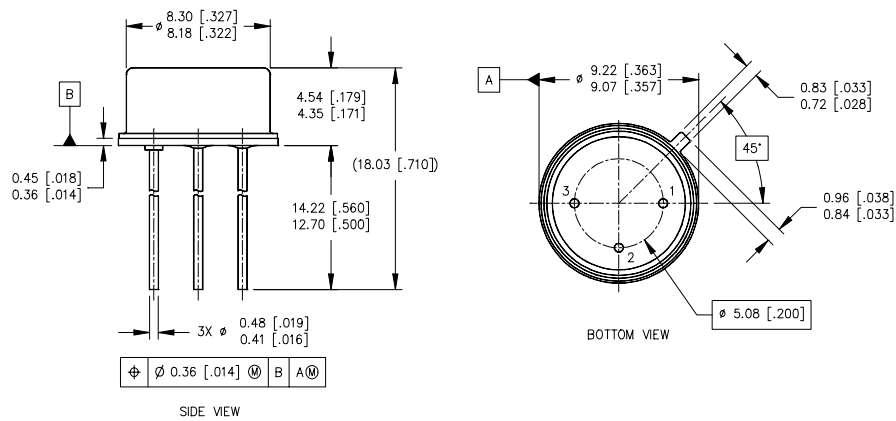

Fig 13b. Gate Charge Test Circuit

**Footnotes:**

- ① Repetitive Rating; Pulse width limited by maximum junction temperature.
- ② V<sub>DD</sub> = 20V, starting T<sub>J</sub> = 25°C, L= 7.2 mH  
Peak I<sub>L</sub> = 12A, V<sub>GS</sub> = 12V
- ③ ISD ≤ 12A, di/dt ≤ 135A/μs,  
V<sub>DD</sub> ≤ 30V, T<sub>J</sub> ≤ 150°C
- ④ Pulse width ≤ 300 μs; Duty Cycle ≤ 2%
- ⑤ **Total Dose Irradiation with V<sub>GS</sub> Bias.**  
12 volt V<sub>GS</sub> applied and V<sub>DS</sub> = 0 during irradiation per MIL-STD-750, method 1019, condition A.
- ⑥ **Total Dose Irradiation with V<sub>DS</sub> Bias.**  
24 volt V<sub>DS</sub> applied and V<sub>GS</sub> = 0 during irradiation per MIL-STD-750, method 1019, condition A.

**Case Outline and Dimensions — TO-205AF (Modified TO-39)**



**NOTES:**

- DIMENSIONING AND TOLERANCING PER ASME 14.5M-1994.
- DIMENSIONS ARE SHOWN IN MILLIMETERS [INCHES].
- CONTROLLING DIMENSION: INCH.
- CONFORMS TO JEDEC OUTLINE TO-205AF (TO-39).

**LEGEND**

- SOURCE
- GATE
- DRAIN

International  
**IR Rectifier**

IR WORLD HEADQUARTERS: 233 Kansas St., El Segundo, California 90245, USA Tel: (310) 252-7105  
 TAC Fax: (310) 252-7903

Visit us at [www.irf.com](http://www.irf.com) for sales contact information.  
 Data and specifications subject to change without notice. 07/02