

LS-377

3.5 Miniboard

User's Manual

Edition 1.1
2011/01/20



Copyright

Copyright 2010, all rights reserved. This document is copyrighted and all rights are reserved. The information in this document is subject to change without prior notice to make improvements to the products.

This document contains proprietary information and protected by copyright. No part of this document may be reproduced, copied, or translated in any form or any means without prior written permission of the manufacturer.

All trademarks and/or registered trademarks contains in this document are property of their respective owners.

Disclaimer

The company shall not be liable for any incidental or consequential damages resulting from the performance or use of this product.

The company does not issue a warranty of any kind, express or implied, including without limitation implied warranties of merchantability or fitness for a particular purpose.

The company has the right to revise the manual or include changes in the specifications of the product described within it at any time without notice and without obligation to notify any person of such revision or changes.

Trademark

All trademarks are the property of their respective holders.

Any questions please visit our website at <http://www.commell.com.tw>

Packing List:

Please check the package content before you starting using the board.

Hardware:

LS-377 3.5" Miniboard x 1

Cable Kit:



SATA Cable x 1
(OALSATA-L)



DC Power Cable x 1
(OALDC-2)

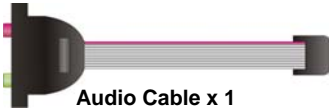

Audio Cable x 1
(OALPJ-HDUNB)



COM Port Cable x 1
(OALES-BKU1NB)



PS/2 Keyboard & Mouse Cable x 1
(OALPS2/MK)



1 to 3 Power Output Cable x 1
(OAL4P-2)



SATA Power Cable x 1
(OAL4P-S1)

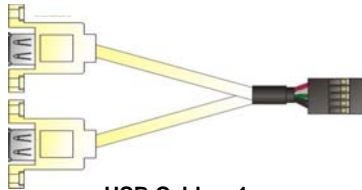

USB Cable x 1
(OALUSBA-3)



CPU Cooler x 1
(OHS-P-M-G)



DVI Module With DVI Cable x 1
(BADPDVI-A + OALDVI-P)

Printed Matters:

Driver CD (Including User's Manual) x 1

Index

Chapter 1 <Introduction>	5
1.1 <Product Overview>	5
1.2 <Product Specification>.....	6
1.3 <Mechanical Drawing>.....	7
1.4 <Block Diagram>.....	8
Chapter 2 <Hardware Setup>	9
2.1 <Connector Location>	9
2.2 <Jumper Location & Reference>.....	11
2.3 <Connector Reference>	13
2.3.1 <Internal Connectors>	13
2.3.2 <External Connectors>	13
2.4 <CPU and Memory Setup>	14
2.4.1 <CPU Setup>.....	14
2.4.2 <Memory Setup>	15
2.5 <CMOS Setup>	16
2.6 <Serial ATA Interface>	17
2.7 <Ethernet Interface>.....	18
2.8 <Onboard Display Interface>	19
2.8.1 <Analog Display>.....	19
2.8.2 <Digital Display>	20
2.8.3 <DVI Interface>.....	24
2.9 <Integrated Audio Interface>	25
2.10 <GPIO and SMBUS Interface>.....	27
2.11 <Power Supply>	28
2.11.1 <Power Input>.....	28
2.13.2 <Power Output>.....	29
2.12 <Switch and Indicator>	30
Chapter 3 <System Setup>	31
3.1 <Audio Configuration>.....	31

3.2 <Display Properties Setting>	32
Chapter 4 <BIOS Setup>.....	34
Appendix A <I/O Port Pin Assignment>.....	35
A.1 <Serial ATA Port>	35
A.2 <IrDA Port>.....	35
A.4 <Serial Port 2>	35
A.5 <VGA Port>	36
A.6 <LAN Port>.....	36
A.7 < USB Interface >.....	36
Appendix B <Flash BIOS>	37
B.1 <Flash Tool>.....	37
B.2 <Flash BIOS Procedure>	37
Appendix C <System Resources>	38
C.1 <I/O Port Address Map>.....	38
C.2 <Memory Address Map>	40
C.3 <System DMA & IRQ Resources>	41
Appendix D <Programming GPIO's>	42
Appendix E <Programming Watchdog Timer >	43
Appendix F <How to setting RS-232/RS-422/RS-485>.....	44
Contact Information	45

Chapter 1 <Introduction>

1.1 <Product Overview>

LS-377Q the new generation of the 3.5 miniboard, supports Intel Core i7, Core i5 and Core i3 Processors and features Intel QM57 chipset, integrated HD Graphics, DDR3 memory, REALTEK High Definition Audio, Serial ATA and 1 x Intel Gigabit LAN.

Intel Arrandale and Clarkfield Processor

The board supports Intel Core i7, Core i5 and Core i3 Processors with, 8MB Intel® Smart Cache, to provide more powerful performance than before.

New features for Intel QM57 chipset

The board integrates Intel QM57 chipset, to provide new generation of the mobile solution, supports integrated HD Graphics, DDR3 800/1066 MHz memory, built-in high speed mass storage interface of Serial ATA, High Definition Audio with 7.1 channels surrounding sound.

All in One multimedia solution

Based on Intel QM57 chipset, the board provides high performance onboard graphics, 24-bit dual channel LVDS interface, DVI and 7.1 channels High Definition Audio, to meet the very requirement of the multimedia application.

Flexible Extension Interface

The board provides, one mini-PCIE socket, one mini-PCI socket.

1.2 <Product Specification>

General Specification

Form Factor	3.5" Miniboard
CPU	Intel® Core™ i7, Core™ i5, Core™ i3, Celeron®, and Pentium® Mobile Processor Package type: rPGA988A
Memory	1 x DDRIII SO-DIMM 800/1066 MHz up to 4GB
Chipset	Intel QM57
Real Time Clock	Chipset integrated RTC with onboard lithium battery
Watchdog Timer	Generates a system reset with internal timer for 1min/s ~255min/s
Power Management	Supports ACPI 2.0 compliant,
Serial ATA Interface	2 x serial ATAI interface with 300MB/s transfer rate
VGA Interface	Intel integrated extreme GMA 4500MHD (Graphic Media Accelerator) Technology
LVDS Interface	Onboard 24-bit dual channel LVDS connector with +3.3V/+5V/+12V supply
DVI Interface	DVI interface
Audio Interface	Realtek ALC888 HD Audio
LAN Interface	1 x Intel 82574L Gigabit LAN
GPIO Interface	Onboard programmable 8-bit Digital I/O interface
Extended Interface	1 x Mini PCIE socket, 1 x Mini PCI socket to support Mini PCI Type IIIA
Internal I/O Port	1 x RS232/422/485, 1 x SMBUS, 1 x GPIO port, 4 x USB ports, 1 x IrDA, 2 x Serial ATA, 1x LVDS, 1 x DIO, 1x LCD inverter connector, 1 x Audio connector and 1 x DCOU connector
External I/O Port	1 x PS/2 Keyboard/Mouse Port, 1 x RJ45 LAN ports, 1 x VGA port, 2 x USB2.0 ports, 1 x RS232 port
Power Requirement	9~24V full range DC Input
Dimension	146mm x 101mm
Temperature	Operating within 0~60 centigrade Storage within -20~85 centigrade

Ordering Code

LS-377Q	Intel Arrandale + QM57 Onboard VGA, LVDS, LAN, USB2.0, HD Audio, SATA, SMBUS, Mini PCI and PCIE mini card
MPX-7202	PCI Express mini card supports 2 x USB 3.0 provides up to 4.8Gbps of transferring rate.

The specifications may be different as the actual production.

For further product information please visit the website at <http://www.comnell.com.tw>

1.3 <Mechanical Drawing>

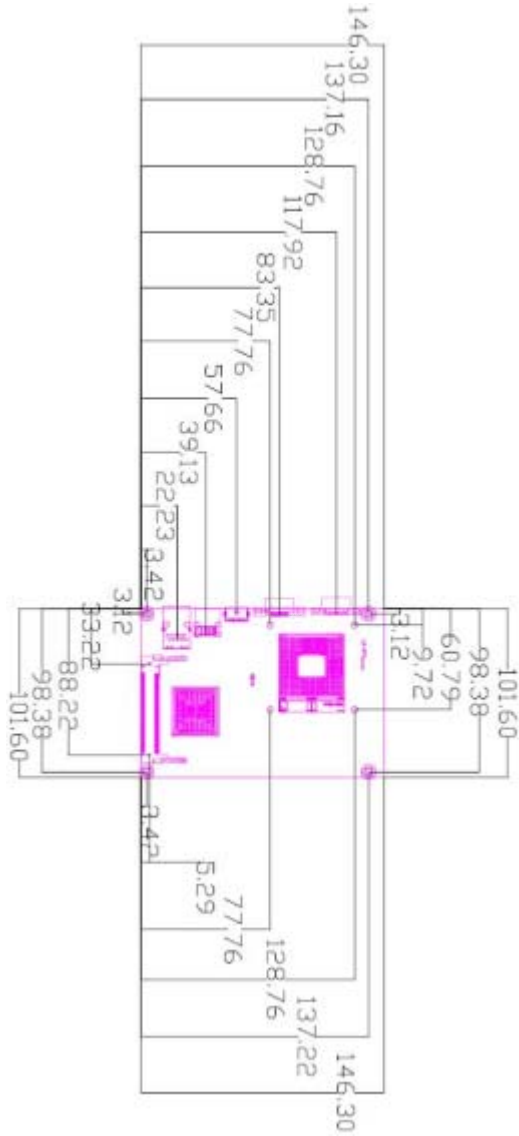

Unit: inch

1.4 <Block Diagram>

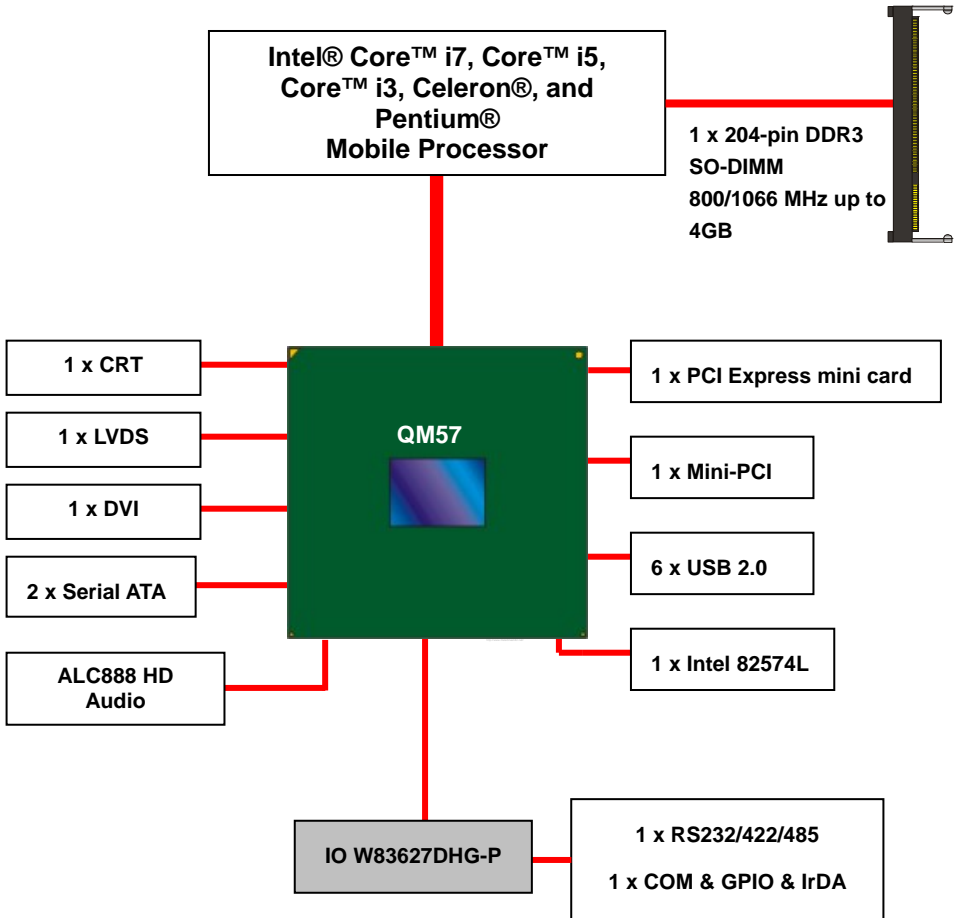

Chapter 2 <Hardware Setup>

2.1 <Connector Location>

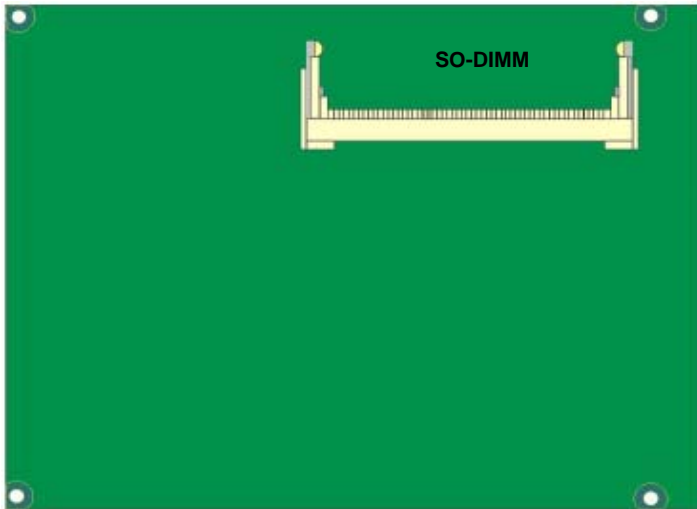
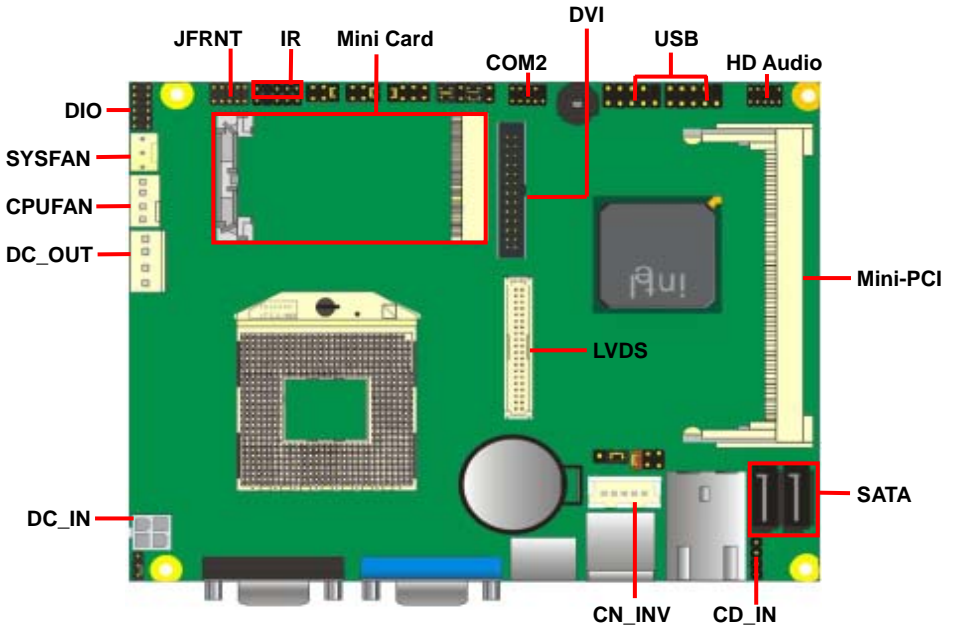

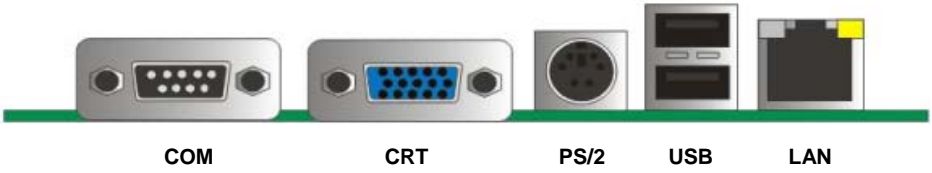

2.2 <Jumper Location & Reference>

Jumper	Function
JRTC	CMOS Operating/Clear Setting
JVLCD	Panel Voltage Setting
JAT	Power mode select
JP1	Com1 Voltage Setting
JP2	Com2 Voltage Setting

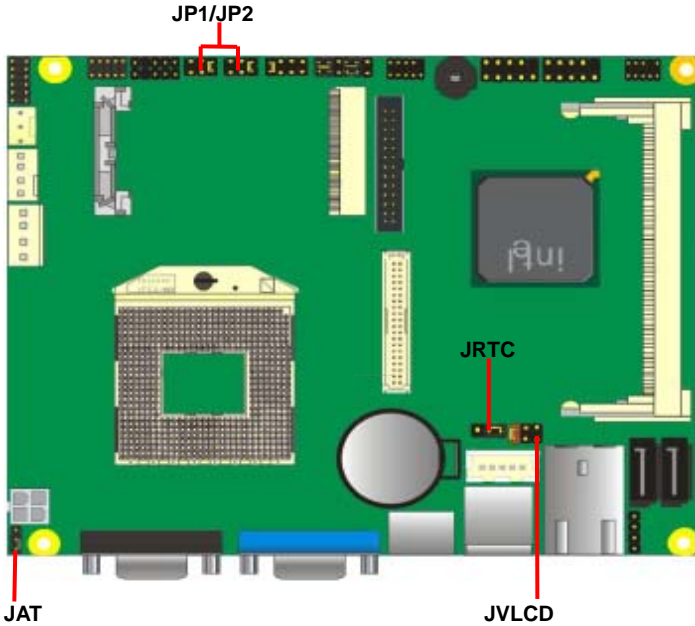

Jumper: **JAT**

Type: onboard 3-pin header

Power Mode	JAT
AT Mode	1-2
ATX Mode	2-3
Default setting: ATX Mode	
	

Jumper: **JP1 (COM 1)**

Type: onboard 6-pin header

Power Mode	JP1
Pin1 with 5V signal	1-2,5-6
Pin9 with 12V signal	3-4,5-6
Default setting: 5-6	
	

Jumper: **JP2 (COM 2)**

Type: onboard 6-pin header

Power Mode	JP2
Pin1 with 5V signal	1-2,5-6
Pin9 with 12V signal	3-4,5-6
Default setting: 5-6	
	

2.3 <Connector Reference>

2.3.1 <Internal Connectors>

Connector	Function	Remark
CPU	Socket rPGA989 for PGA988 CPU	
SO-DIMM	204 -pin DDR3 SO-DIMM socket	
SATA1/2	7-pin Serial ATA connector	
DC_IN	DC 9~24V input connector	
CN_AUDIO	5 x 2-pin audio connector	
CD_IN	4-pin CD-ROM audio input connector	
CN_DIO	6 x 2-pin digital I/O connector	
CN_USB 1/2	5 x 2-pin USB connector	
CPUFAN	4-pin CPU cooler fan connector	
SYSFAN	3-pin system cooler fan connector	
CN_LVDS	20 x 2-pin LVDS connector	
CN_INV	5-pin LCD inverter connector	
CN_IR	5-pin IrDA connector	
JFRNT	10-pin front panel switch/indicator connector	
Mini-PCI	124-pin Mini-PCI socket Type IIIA	
Mini-PCIE	52-pin Mini-PCIE socket	
CN_COM2	9-pin RS422/485/232	
JAT	Power mode select	

2.3.2 <External Connectors>

Connector	Function	Remark
RJ45	RJ45 LAN connector	
COM1 + CRT	COM1 Connect DB15 and analog VGA connector	
PS/2	PS/2 keyboard and mouse connector	
USB	2 x USB	

2.4 <CPU and Memory Setup>

2.4.1 <CPU Setup>

The board comes with the socket rPGA989 for Intel **Arrandale and Clarkfield** Processor, Intel® Smart 8MB Cache. Please follow the instruction to install the CPU properly.

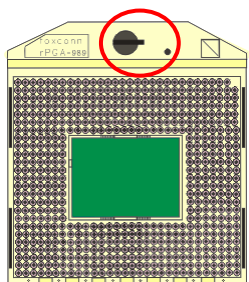

1. Use the flat-type screw drive to unlock the CPU socket



Unlock way

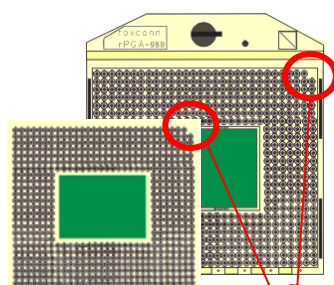

Check point

2. Follow the pin direction to install the processor on the socket



3. Lock the socket

4. CPU socket has 989 pins

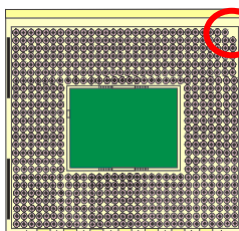

Socket-M CPU
Check point

2.4.2 <Memory Setup>

The board provides 1 x 204-pin DDR3 SO-DIMM to support 800/1066MHz DDR3 memory module up to 4GB.

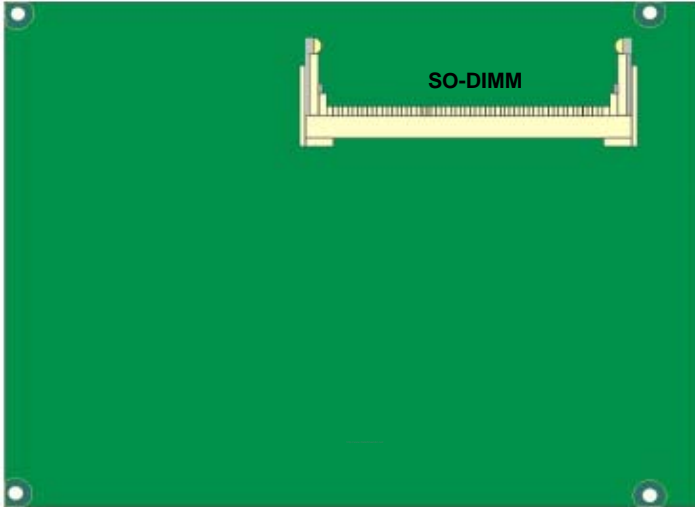

2.5 <CMOS Setup>

The board's data of CMOS can be setting in BIOS. If the board refuses to boot due to inappropriate CMOS settings, here is how to proceed to clear (reset) the CMOS to its default values.

Jumper: JRTC

Type: Onboard 3-pin jumper

JRTC	Mode
1-2	Clear CMOS
2-3	Normal Operation

Default setting: 2-3

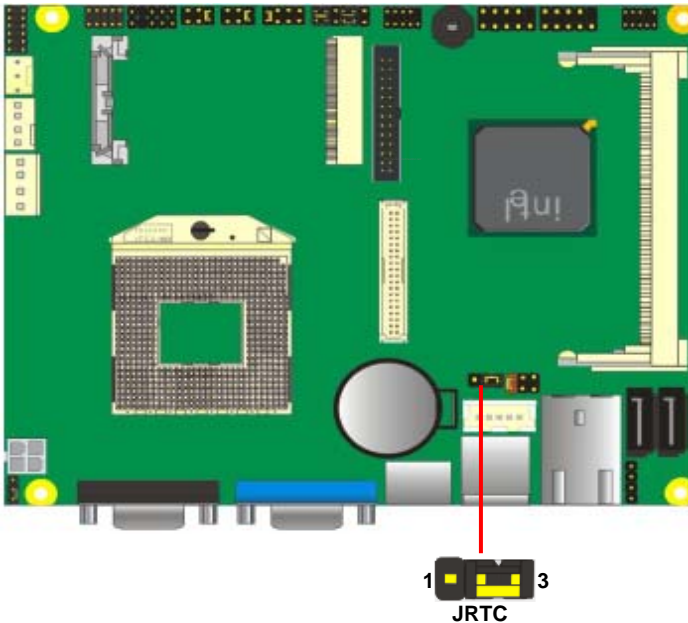

2.6 <Serial ATA Interface>

Based on Intel QM57, the board provides four Serial ATAII interfaces with up to 300MB/s of transfer rate.

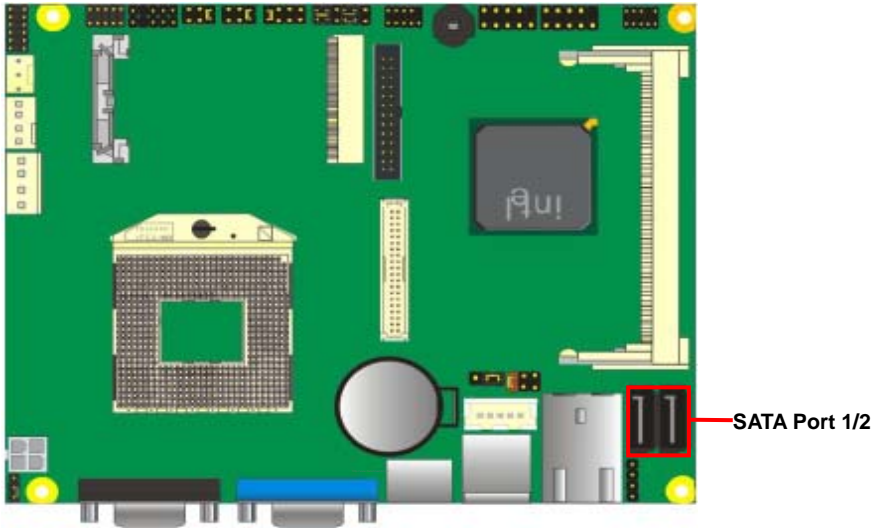

2.7 <Ethernet Interface>

The board integrates with one Intel PCI Express Gigabit Ethernet controllers, as the PCI Express x 1 can speed up to 250MB/s of transfer rate instead of late PCI bus with 133MB/s of transfer rate. The Intel Gigabit Ethernet supports triple speed of 10/100/1000Base-T, with IEEE802.3 compliance and Wake-On-LAN supported.



2.8 <Onboard Display Interface>

Based on Intel **Arrandale** CPU with built-in HD Graphic, the board provides one DB15 connector on rear external I/O port, one 40-pin LVDS interface with 5-pin LCD backlight inverter connector optional or Secondary CRT connector and provides optional 26-pin DVI interface.

The board provides dual display function with clone mode and extended desktop mode for CRT, LCD and DVI.

2.8.1 <Analog Display>

Please connect your CRT or LCD monitor with DB15 male connector to the onboard DB15 female connector on rear I/O port or optional Secondary CRT connect.

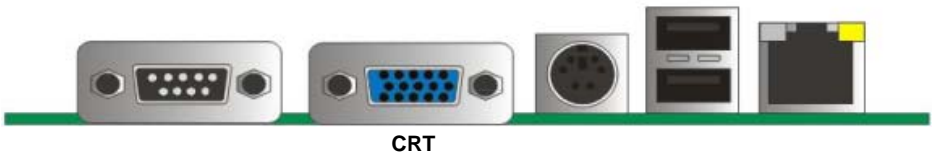

2.8.2 <Digital Display>

The board provides one 40-pin LVDS connector for 24-bit single/dual channel panels, supports up to 1920 x 1200 (UXGA) resolution, with one LCD backlight inverter connector and one jumper for panel voltage setting.

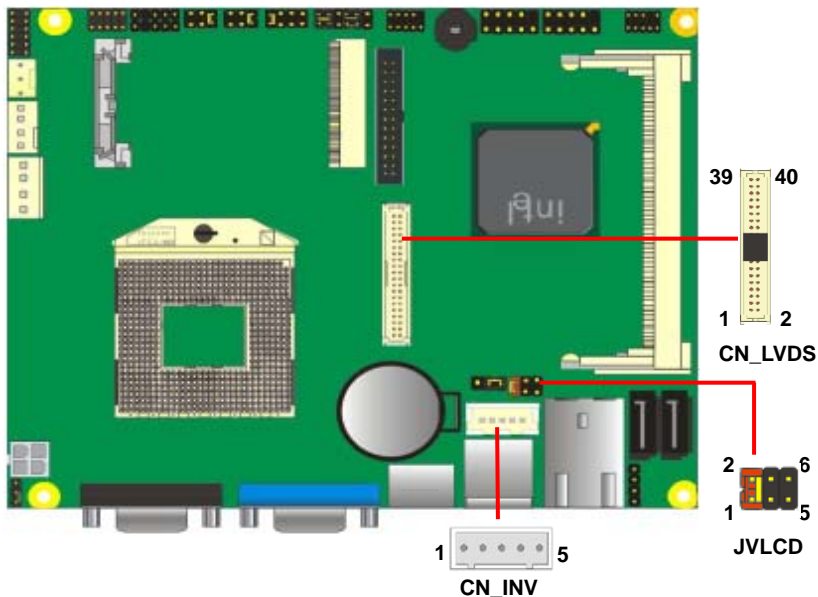

Effective patterns of connection: 1-2 / 3-4 / 5-6

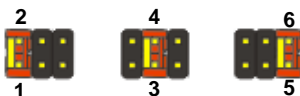

Warning: others cause damages

Connector: **CN_INV**

Type: 5-pin LVDS Power Header

Pin	Description
1	+12V
2	Reserved (Note)
3	GND
4	GND
5	ENABKL

Note: Reserved for MB internal test
Please treat it as NC.

Connector: **JVLCD**

Type: 6-pin Power select Header

Pin	Description
1-2	LCDVCC (3.3V)
3-4	LCDVCC (5V)
5-6	LCDVCC (12V)

Default: 1-2

Connector: **CN_LVDS**

Type: onboard 40-pin connector for LVDS connector

Connector model: **HIROSE DF13-40DP-1.25V**

Pin	Signal	Pin	Signal
2	LCDVCC	1	LCDVCC
4	GND	3	GND
6	ATX0-	5	BTX0-
8	ATX0+	7	BTX0+
10	GND	9	GND
12	ATX1-	11	BTX1-
14	ATX1+	13	BTX1+
16	GND	15	GND
18	ATX2-	17	BTX2-
20	ATX2+	19	BTX2+
22	GND	21	GND
24	ACLK-	23	BTX3-
26	ACLK+	25	BTX3+
28	GND	27	GND
30	ATX3-	29	BCLK-
32	ATX3+	31	BCLK+
34	GND	33	GND
36	DDCPCLK	35	N/C
38	DDCPDATA	37	N/C
40	N/C	39	N/C

LS-377 User's Manual

To setup the LCD, you need the component below:

1. A panel with LVDS interfaces.
2. An inverter for panel's backlight power.
3. A LCD cable and an inverter cable.

For the cables, please follow the pin assignment of the connector to make a cable, because every panel has its own pin assignment, so we do not provide a standard cable; please find a local cable manufacture to make cables.

LCD Installation Guide:

1. Preparing the **LS-377**, **LCD panel** and the **backlight inverter**.

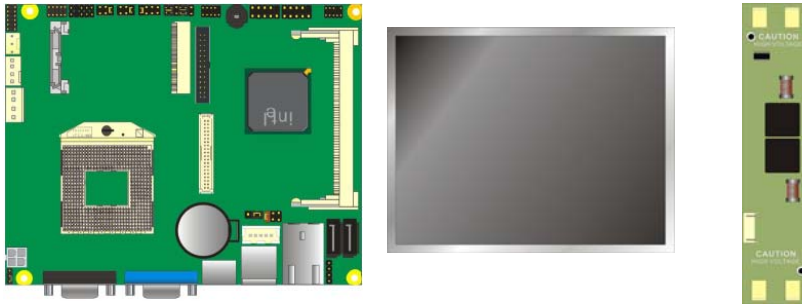

2. Please check the datasheet of the panel to see the voltage of the panel, and set the jumper **JVLCD** to +12V or +5V or +3.3V.
3. You would need a LVDS type cable.

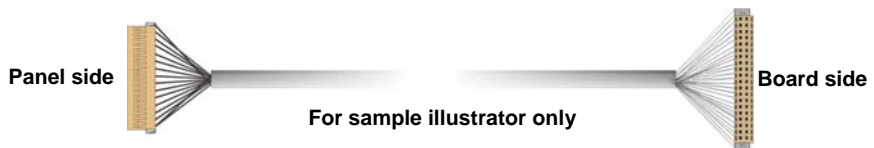

4. To connect all of the devices well.

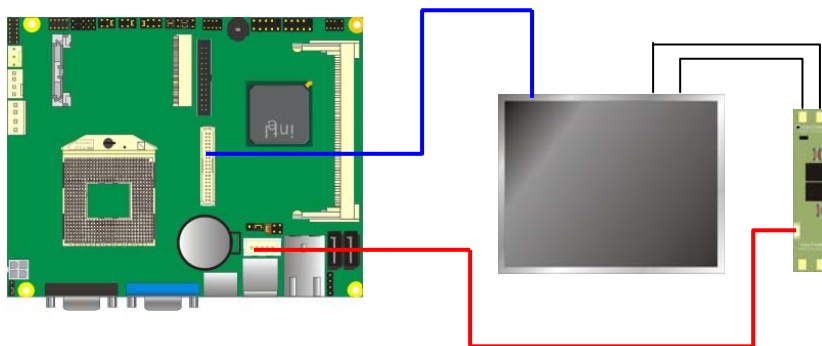

After setup the devices well, you need to select the LCD panel type in the BIOS.

The panel type mapping is list below:

BIOS panel type selection form (BIOS Version:1.0)			
18-bit Single channel		24-bit Dual channel	
NO.	Output format	NO.	Output format
1	640 x 480	11	1280 x 768
2	800 x 480	12	1280 x 1024
3	800 x 600	13	1600 x 1200
4	1024 x 768	14	1920 x 1080
5	1280 x 800	15	1920 x 1200
18-bit Dual channel			
6	1280 x 768		
24-bit Single channel			
7	1024 x 768		
8	1280 x 768		
9	1280 x 800		
10	1366 x 768		

2.8.3 <DVI Interface>

The board provides an option 26-pin DVI interface

Connector: **CN_DVI**

Connector type: 26-pin header connector (pitch = 2.00mm)

Pin Number	Assignment	Pin Number	Assignment
1	TX1+	2	TX1-
3	Ground	4	Ground
5	TXC+	6	TXC-
7	Ground	8	+5V
9	N/C	10	N/C
11	TX2+	12	TX2-
13	Ground	14	Ground
15	TX0+	16	TX0-
17	N/C	18	HPDET
19	DDCDATA	20	DDCCLK
21	GND	22	N/C
23	N/C	24	N/C
25	N/C	26	N/C

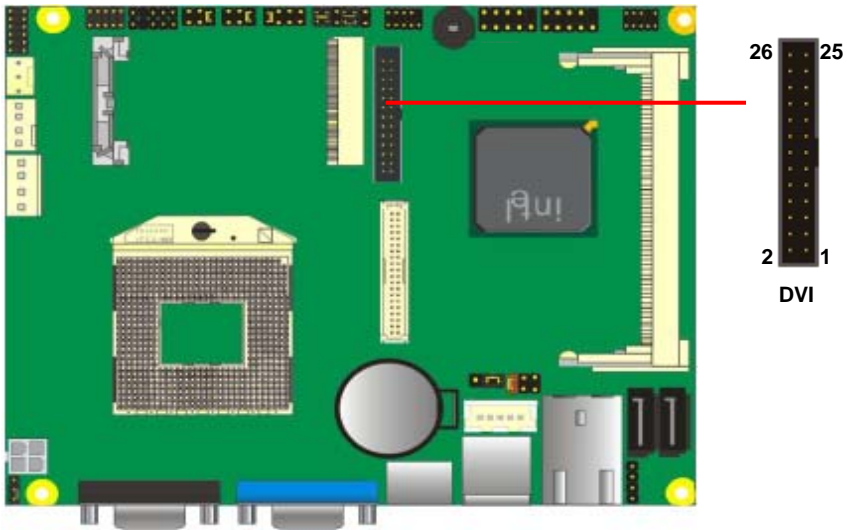

2.9 <Integrated Audio Interface>

The board integrates onboard audio interface with REALTEK ALC888 codec, with Intel next generation of audio standard as High Definition Audio, it offers more sound and other advantages than former ALC888 audio compliance.

The main specifications of ALC888 are:

- High-performance DACs with 100dB S/N ratio
- 8 DAC channels support 16/20/24-bit PCM format for 7.1 audio solution
- 16/20/24-bit S/PDIF-OUT supports 44.1K/48K/96kHz sample rate
- Compatible with ALC888
- Meets Microsoft WHQL/WLP 2.0 audio requirements

The board provides 7.1 channels audio phone jacks on rear I/O port, and Line-in/MIC-in ports for front I/O panel through optional cable.

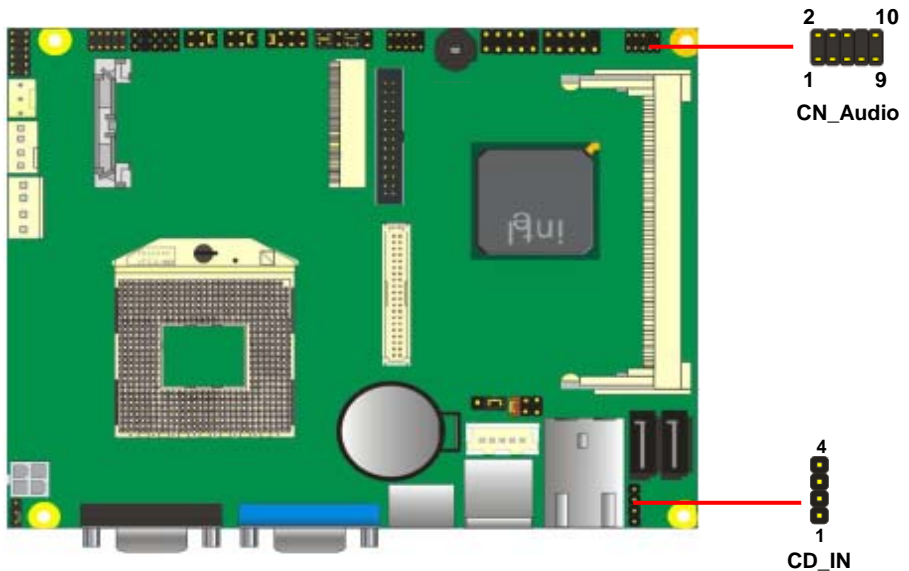

Connector: CN_AUDIO

Type: 10-pin (2 x 5) header (pitch = 2.54mm)



Pin	Description	Pin	Description
1	MIC_L	2	Ground
3	MIC_R	4	Reserve
5	Speaker_R	6	MIC Detect
7	SENSE	8	N/C
9	Speaker_L	10	Speaker Detect

Connector: CDIN

Type: 4-pin header (pitch = 2.54mm)

Pin	Description
1	CD – Left
2	Ground
3	Ground
4	CD – Right



2.10 <GPIO and SMBUS Interface>

The board provides a programmable 8-bit digital I/O interface; you can use this general purpose I/O port for system control like POS or KIOSK.

Connector: **CN_DIO**

Type: 12-pin (6 x 2) header (pitch = 2.0mm)

Pin	Description	Pin	Description
1	Ground	2	Ground
3	GP10	4	GP14
5	GP11	6	GP15
7	GP12	8	GP16
9	GP13	10	GP17
11	VCC	12	+12V

Connector: **CN_SMBUS**

Type: 5-pin header for SMBUS Ports

Pin	Description
1	VCC
2	N/C
3	SMBDATA
4	SMBCLK
5	Ground

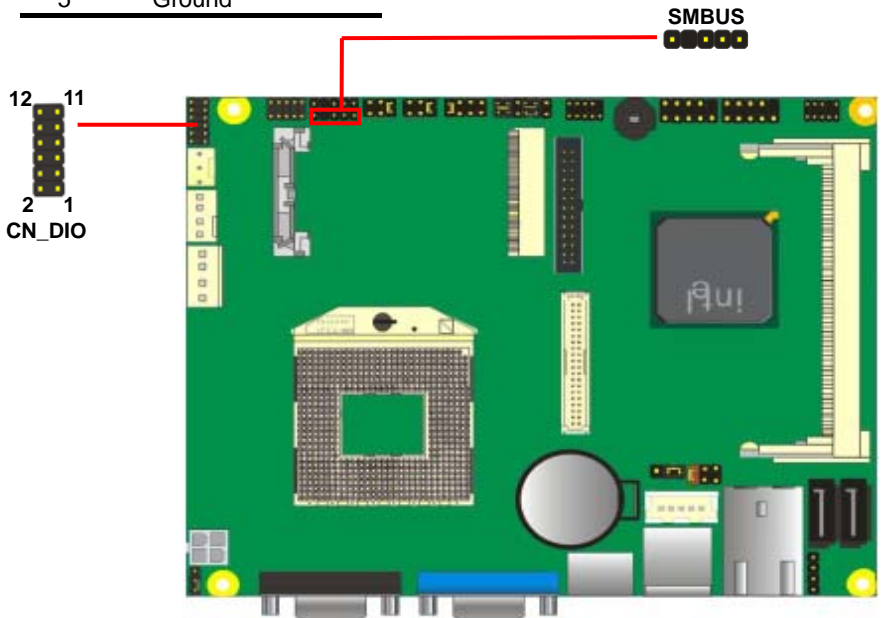

2.11 <Power Supply>

2.11.1 <Power Input>

The board requires onboard 4-pin DC-input connector voltage range is from 9V to 24V, or onboard 20-pin ATX2.0, for the input current, please take a reference of the power consumption report on appendix.

Connector: **DC_IN**

Type: 4-pin DC power connector

Pin	Description	Pin	Description
1	Ground	2	Ground
3	+9~24V	4	+9~24V

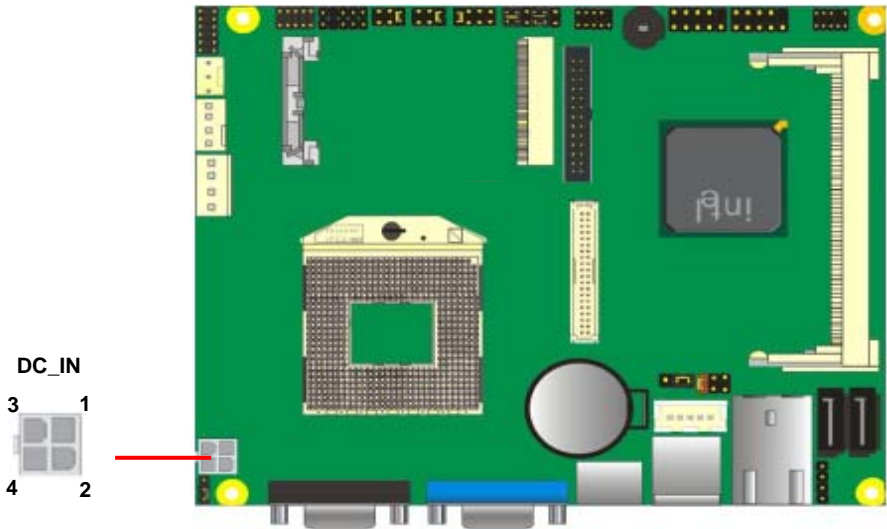

2.13.2 <Power Output>

Connector: DC_OUT

Type: 4-pin connector for +5V/+12V output

Pin	Description
1	+12V
2	GND
3	GND
4	+5V

Note: Maximum output current **12V/1A, 5V/1A**

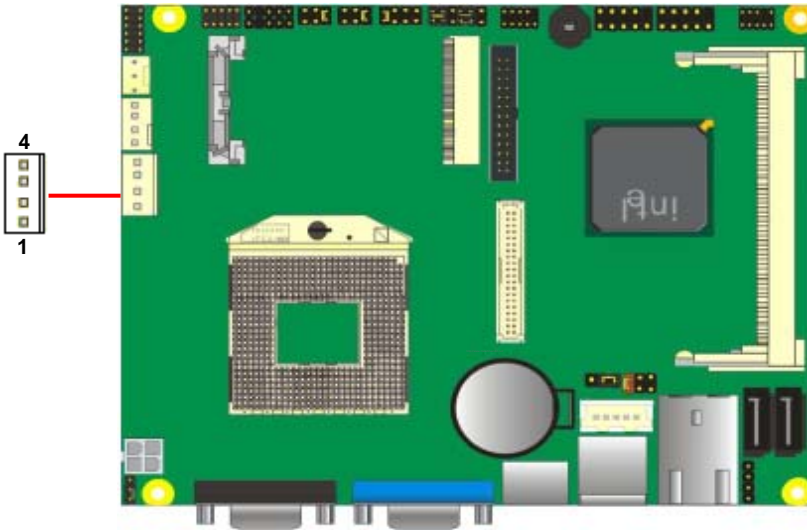

2.12 <Switch and Indicator>

The **JFRNT** provides front control panel of the board, such as power button, reset and beeper, etc. Please check well before you connecting the cables on the chassis.

Connector: **JFRNT**

Type: onboard 10-pin (2 x 5) 2.54-pitch header

Function	Signal	PIN		Signal
Power	PWRBT-	1	2	PWRBT+
Speaker	SPK-	3	4	SPK+
HDD LED	HLED-	5	6	HLED+
Power LED	GND	7	8	PWLED+
Reset	Reset-	9	10	GND

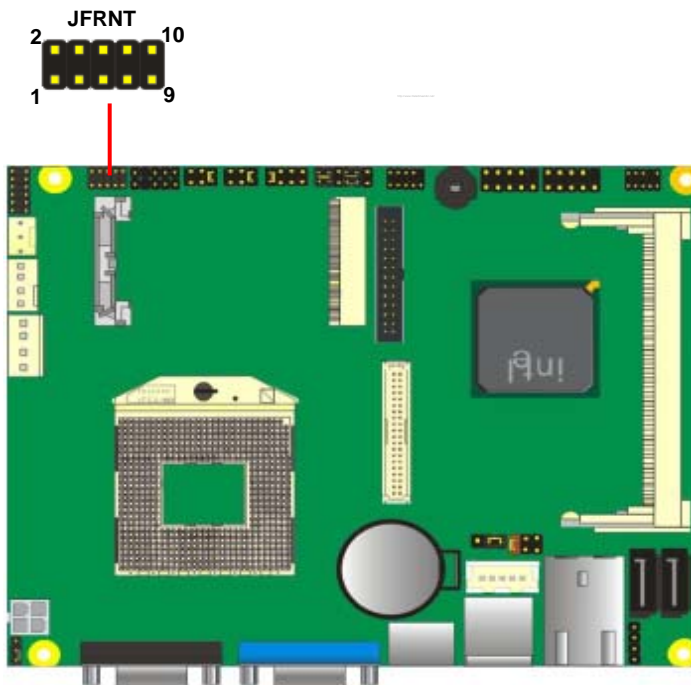

Chapter 3 <System Setup>

3.1 <Audio Configuration>

The board integrates Intel® QM57 with REALTEK® ALC888 codec. It can support 2-channel or 7.1 channel sound under system configuration. Please follow the steps below to setup your sound system.

1. Install REALTEK HD Audio driver.
2. Launch the control panel and Sound Effect Manager.

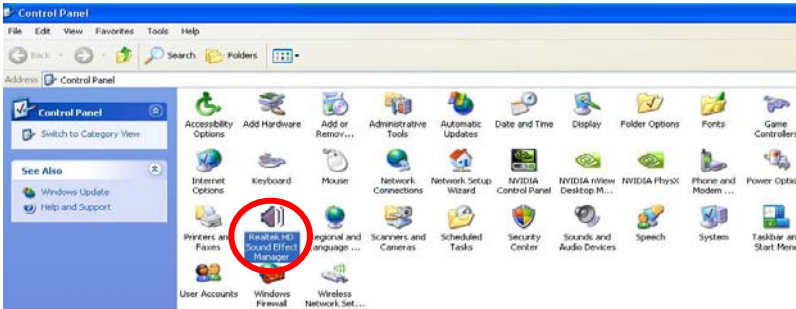

3. Select Speaker Configuration



3.2 <Display Properties Setting>

Based on Intel GM45 GMCH with GMA 4500MHD (Graphic Media Accelerator), the board supports two DACs for display device as different resolution and color bit.

Please install the Intel Graphic Driver before you starting setup display devices.

1. Click right button on the desktop to lunch **display properties**

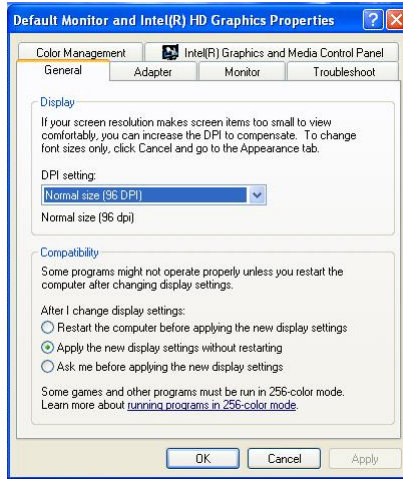

2. Click **Advanced** button for more specificity setup.

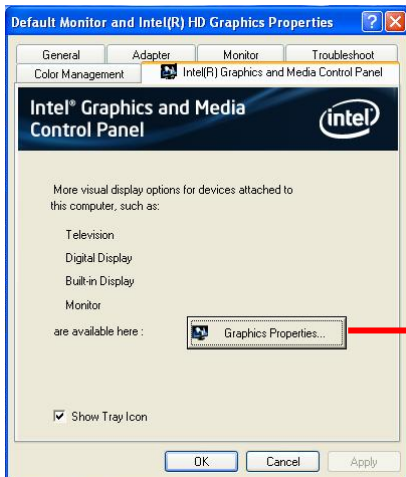

Click Graphics Properties... for advanced setup

4. This setup options can let you define each device settings.

Click **Monitor** to setup the CRT monitor for Resolution and Refresh Rate



Click **Intel® Dual Display Clone** to setup the dual display mode as same screen

Chapter 4 <BIOS Setup>

The motherboard uses the Phoenix BIOS for the system configuration. The Phoenix BIOS in the single board computer is a customized version of the industrial standard BIOS for IBM PC AT-compatible computers. It supports Intel x86 and compatible CPU architecture based processors and computers. The BIOS provides critical low-level support for the system central processing, memory and I/O sub-systems.

The BIOS setup program of the single board computer let the customers modify the basic configuration setting. The settings are stored in a dedicated battery-backed memory, NVRAM, retains the information when the power is turned off. If the battery runs out of the power, then the settings of BIOS will come back to the default setting.

The BIOS section of the manual is subject to change without notice and is provided here for reference purpose only. The settings and configurations of the BIOS are current at the time of print, and therefore they may not be exactly the same as that displayed on your screen.

To activate CMOS Setup program, press key immediately after you turn on the system. The following message "Press DEL to enter SETUP" should appear in the lower left hand corner of your screen. When you enter the CMOS Setup Utility, the Main Menu will be displayed as **Figure 4-1**. You can use arrow keys to select your function, press <Enter> key to accept the selection and enter the sub-menu.

Figure 4-1 CMOS Setup Utility Main Screen

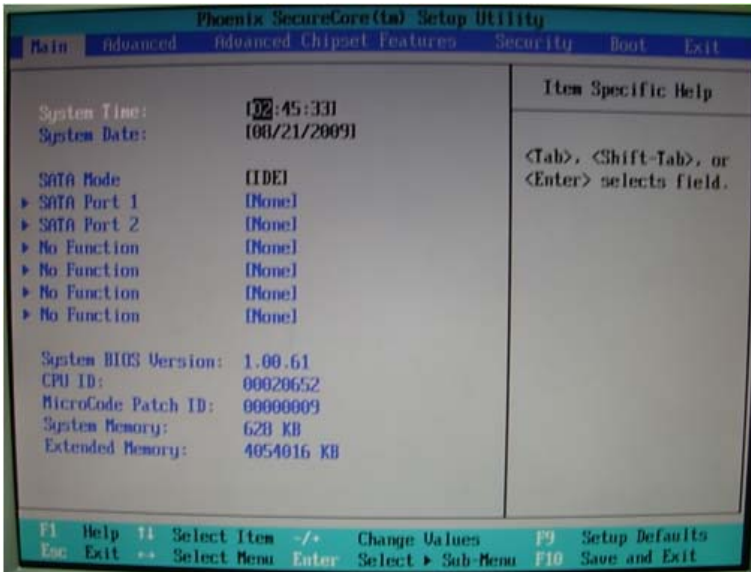

Appendix A <I/O Port Pin Assignment>

A.1 <Serial ATA Port>

Connector: **SATA1/2**

Type: 7-pin wafer connector

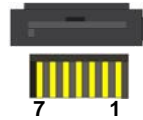

1	2	3	4	5	6	7
GND	RSATA_TXP1	RSATA_TXN1	GND	RSATA_RXN1	RSATA_RXP1	GND

A.2 <IrDA Port>

Connector: **CN_IR**

Type: 5-pin header for SIR Ports

JCSEL1 must jump to "SIR"

Pin	Description
1	VCC
2	N/C
3	IRRX
4	Ground
5	IRTX



A.3 <Serial Port 1>

Connector: **COM1**

Type: 9-pin D-sub male connector on bracket

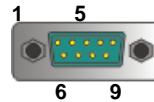

Pin	Description	Pin	Description
1	DCD-	6	DSR
2	SIN-	7	RTS
3	SO-	8	CTS
4	DTR-	9	RI
5	Ground		

A.4 <Serial Port 2>

Connector: **CN_COM2**

Type: 9-pin header connector on bracket



Pin	Description	Pin	Description
1	DCD/422TX-/485	6	DSR
2	RXD/422TX+/485+	7	RTS
3	SO- /422RX+	8	CTS
4	DTR- /422RX-	9	RI
5	Ground		

A.5 <VGA Port>

Connector: **CRT**

Type: 15-pin D-sub female connector on bracket

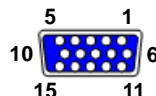

Pin	Description	Pin	Description	Pin	Description
1	RED	6	Ground	11	N/C
2	GREEN	7	Ground	12	DDCDA
3	BLUE	8	Ground	13	HSYNC
4	N/C	9	N/C	14	VSYNC
5	Ground	10	Ground	15	DDCCLK

A.6 <LAN Port>

Connector: **RJ45**

Type: RJ45 connector with LED on bracket

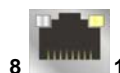

Pin	1	2	3	4	5	6	7	8
Description	TRD0+	TRD0-	TRD1+	TRD2+	TRD2-	TRD1-	TRD3+	TRD3-

A.7 < USB Interface >

Connector: **CN_USB 3/4**

Type: 10-pin (5 x 2) header for dual USB Ports



Pin	Description	Pin	Description
1	VCC	2	VCC
3	Data0-	4	Data1-
5	Data0+	6	Data1+
7	Ground	8	Ground
9	Ground	10	N/C

A.8 < PS2 Port >

The PS/2 connector supports standard PS/2 keyboard directly or both PS/2 keyboard and mouse through for PS/2 Y-cable.

Connector: **PS2**

Type: 6-pin Mini-DIN connector on bracket



Pin	1	2	3	4	5	6
Description	KBCLK	MSCLK	GROUND	VCC	KBDATA	MSDATA

Appendix B <Flash BIOS>

B.1 <Flash Tool>

The board is based on Phoenix BIOS and can be updated easily by the BIOS auto flash tool. You can download the tool online at the address below:

<http://www.phoenix.com/en/home/>

http://www.commell.com.tw/Support/Support_SBC.htm

File name of the tool is "Phlash16.exe", it's the utility that can write the data into the BIOS flash ship and update the BIOS.

B.2 <Flash BIOS Procedure>













































1. Please make a bootable floppy disk.
2. Get the last .bin files you want to update and copy it into the disk.
3. Copy Phlash16.exe to the disk.
4. Power on the system and flash the BIOS. (Example: C:/Phlash16 XXX.ROM)
5. Restart the system.





















Any question about the BIOS re-flash please contact your distributors or visit the web-site at below:

<http://www.commell.com.tw/support/support.htm>

Appendix C <System Resources>

C.1 <I/O Port Address Map>

	[00000000 - 0000001F]	Direct memory access controller
	[00000000 - 00000CF7]	PCI bus
	[00000020 - 00000021]	Programmable interrupt controller
	[00000024 - 00000025]	Programmable interrupt controller
	[00000028 - 00000029]	Programmable interrupt controller
	[0000002C - 0000002D]	Programmable interrupt controller
	[0000002E - 0000002F]	Motherboard resources
	[00000030 - 00000031]	Programmable interrupt controller
	[00000034 - 00000035]	Programmable interrupt controller
	[00000038 - 00000039]	Programmable interrupt controller
	[0000003C - 0000003D]	Programmable interrupt controller
	[00000040 - 00000043]	System timer
	[0000004E - 0000004F]	Motherboard resources
	[00000050 - 00000053]	System timer
	[00000060 - 00000060]	Standard 101/102-Key or Microsoft Natural PS/2 Keyboard
	[00000061 - 00000061]	Motherboard resources
	[00000063 - 00000063]	Motherboard resources
	[00000064 - 00000064]	Standard 101/102-Key or Microsoft Natural PS/2 Keyboard
	[00000065 - 00000065]	Motherboard resources
	[00000067 - 00000067]	Motherboard resources
	[00000070 - 00000070]	Motherboard resources
	[00000070 - 00000077]	System CMOS/real time clock
	[00000080 - 00000080]	Motherboard resources
	[00000081 - 00000091]	Direct memory access controller
	[00000092 - 00000092]	Motherboard resources
	[00000093 - 0000009F]	Direct memory access controller
	[000000A0 - 000000A1]	Programmable interrupt controller
	[000000A4 - 000000A5]	Programmable interrupt controller
	[000000A8 - 000000A9]	Programmable interrupt controller
	[000000AC - 000000AD]	Programmable interrupt controller
	[000000B0 - 000000B1]	Programmable interrupt controller
	[000000B2 - 000000B3]	Motherboard resources
	[000000B4 - 000000B5]	Programmable interrupt controller
	[000000B8 - 000000B9]	Programmable interrupt controller
	[000000BC - 000000BD]	Programmable interrupt controller
	[000000C0 - 000000DF]	Direct memory access controller
	[000000F0 - 000000F0]	Numeric data processor
	[00000274 - 00000277]	ISAPNP Read Data Port
	[00000279 - 00000279]	ISAPNP Read Data Port
	[000002F8 - 000002FF]	Communications Port (COM2)
	[000003B0 - 000003BB]	Intel(R) HD Graphics
	[000003C0 - 000003DF]	Intel(R) HD Graphics
	[000003F8 - 000003FF]	Communications Port (COM1)
	[00000400 - 0000047F]	Motherboard resources
	[000004D0 - 000004D1]	Programmable interrupt controller
	[00000500 - 0000050F]	Motherboard resources
	[00000600 - 00000603]	Motherboard resources
	[00000680 - 0000069F]	Motherboard resources
	[000006A0 - 000006AF]	Motherboard resources
	[000006B0 - 000006FF]	Motherboard resources
	[00000A79 - 00000A79]	ISAPNP Read Data Port

	[00000D00 - 0000FFFF] PCI bus
	[00001180 - 000011FF] Motherboard resources
	[0000164E - 0000164F] Motherboard resources
	[00006C00 - 00006C1F] Intel(R) 5 Series/3400 Series Chipset Family SMBus Controller - 3B30
	[00006C20 - 00006C2F] Intel(R) 5 Series/3400 Series Chipset Family 4 port Serial ATA Storage Controller - 3B2E
	[00006C30 - 00006C3F] Intel(R) 5 Series/3400 Series Chipset Family 4 port Serial ATA Storage Controller - 3B2E
	[00006C40 - 00006C4F] Intel(R) 5 Series/3400 Series Chipset Family 2 port Serial ATA Storage Controller - 3B2D
	[00006C50 - 00006C5F] Intel(R) 5 Series/3400 Series Chipset Family 2 port Serial ATA Storage Controller - 3B2D
	[00006C60 - 00006C67] Intel(R) HD Graphics
	[00006C70 - 00006C73] Intel(R) 5 Series/3400 Series Chipset Family 4 port Serial ATA Storage Controller - 3B2E
	[00006C74 - 00006C77] Intel(R) 5 Series/3400 Series Chipset Family 4 port Serial ATA Storage Controller - 3B2E
	[00006C78 - 00006C7F] Intel(R) 5 Series/3400 Series Chipset Family 4 port Serial ATA Storage Controller - 3B2E
	[00006C80 - 00006C87] Intel(R) 5 Series/3400 Series Chipset Family 4 port Serial ATA Storage Controller - 3B2E
	[00006C88 - 00006C8B] Intel(R) 5 Series/3400 Series Chipset Family 2 port Serial ATA Storage Controller - 3B2D
	[00006C8C - 00006C8F] Intel(R) 5 Series/3400 Series Chipset Family 2 port Serial ATA Storage Controller - 3B2D
	[00006C90 - 00006C97] Intel(R) 5 Series/3400 Series Chipset Family 2 port Serial ATA Storage Controller - 3B2D
	[00006C98 - 00006C9F] Intel(R) 5 Series/3400 Series Chipset Family 2 port Serial ATA Storage Controller - 3B2D
	[00007000 - 0000701F] Intel(R) 82574L Gigabit Network Connection #4
	[00007000 - 00007FFF] Intel(R) 5 Series/3400 Series Chipset Family PCI Express Root Port 1 - 3B42
	[0000FE00 - 0000FE00] Motherboard resources
	[0000FFFF - 0000FFFF] Motherboard resources

C.2 <Memory Address Map>

















	[000A0000 - 000BFFFF] Intel(R) HD Graphics
	[000A0000 - 000BFFFF] PCI bus
	[000D0000 - 000D3FFF] PCI bus
	[000D4000 - 000D7FFF] PCI bus
	[000D8000 - 000DBFFF] PCI bus
	[C0000000 - C0000FFF] Motherboard resources
	[C0000000 - FEFFFFFF] PCI bus
	[D0000000 - DFFFFFFF] Intel(R) HD Graphics
	[E0000000 - EFFFFFFF] Motherboard resources
	[F0000000 - F03FFFFF] Intel(R) HD Graphics
	[F0400000 - F041FFFF] Intel(R) 82574L Gigabit Network Connection #4
	[F0400000 - F04FFFFF] Intel(R) 5 Series/3400 Series Chipset Family PCI Express Root Port 1 - 3B42
	[F0420000 - F0423FFF] Intel(R) 82574L Gigabit Network Connection #4
	[F0700000 - F0703FFF] Microsoft UAA Bus Driver for High Definition Audio
	[F0707000 - F07073FF] Intel(R) 5 Series/3400 Series Chipset Family USB Enhanced Host Controller - 3B3C
	[F0708000 - F07083FF] Intel(R) 5 Series/3400 Series Chipset Family USB Enhanced Host Controller - 3B34
	[F0709000 - F07090FF] Intel(R) 5 Series/3400 Series Chipset Family SMBus Controller - 3B30
	[F070A000 - F070AFFF] Motherboard resources
	[F0800000 - F09FFFFFFF] Intel(R) 5 Series/3400 Series Chipset Family PCI Express Root Port 1 - 3B42
	[FED00000 - FED003FF] High precision event timer
	[FED10000 - FED13FFF] Motherboard resources
	[FED18000 - FED18FFF] Motherboard resources
	[FED19000 - FED19FFF] Motherboard resources
	[FED1C000 - FED1FFFF] Motherboard resources
	[FED20000 - FED3FFFF] Motherboard resources
	[FED40000 - FED44FFF] Motherboard resources
	[FED45000 - FED8FFFF] Motherboard resources
	[FED90000 - FED93FFF] Motherboard resources
	[FEE00000 - FEEFFFFFFF] Motherboard resources
	[FF000000 - FFFFFFFF] Intel(R) 82802 Firmware Hub Device
	[FF000000 - FFFFFFFF] Motherboard resources

C.3 <System DMA & IRQ Resources>

DMA:

-  4 Direct memory access controller

IRQ:

-  (ISA) 0 High precision event timer
-  (ISA) 1 Standard 101/102-Key or Microsoft Natural PS/2 Keyboard
-  (ISA) 3 Communications Port (COM2)
-  (ISA) 4 Communications Port (COM1)
-  (ISA) 8 High precision event timer
-  (ISA) 9 Microsoft ACPI-Compliant System
-  (ISA) 12 PS/2 Compatible Mouse
-  (ISA) 13 Numeric data processor
-  (PCI) 5 Intel(R) 5 Series/3400 Series Chipset Family SMBus Controller - 3B30
-  (PCI) 16 Intel(R) 5 Series/3400 Series Chipset Family PCI Express Root Port 1 - 3B42
-  (PCI) 16 Intel(R) 5 Series/3400 Series Chipset Family USB Enhanced Host Controller - 3B3C
-  (PCI) 16 Intel(R) 82574L Gigabit Network Connection #4
-  (PCI) 16 Intel(R) HD Graphics
-  (PCI) 19 Intel(R) 5 Series/3400 Series Chipset Family 2 port Serial ATA Storage Controller - 3B2D
-  (PCI) 19 Intel(R) 5 Series/3400 Series Chipset Family 4 port Serial ATA Storage Controller - 3B2E
-  (PCI) 22 Microsoft UAA Bus Driver for High Definition Audio
-  (PCI) 23 Intel(R) 5 Series/3400 Series Chipset Family USB Enhanced Host Controller - 3B34

Appendix D <Programming GPIO's>

The GPIO can be programmed with the MSDOS debug program using simple IN/OUT commands. The following lines show an example how to do this.

```
GPIO0.....GPIO7  bit0.....bit7
-o 2 E 87          ;enter configuration
-o 2E 87
-o 2E 07
-o 2F 09          ;enale GPIO function
-o 2E 30
-o 2F 02          ;enable GPIO configuration
-o 2E F0
-o 2F xx          ;set GPIO as input/output; set '1' for input,'0'for
output
-o 2E F1
-o 2F xx          ;if set GPIO's as output,in this register its value can
be set
```

Optional :

```
-o 2E F2
-o 2F xx          ; Data inversion register ; '1' inverts the current valus
of the bits ,'0' leaves them as they are
-o 2E 30
-o 2F 01          ; active GPIO's
```

For further information ,please refer to Winbond W83627DHG datasheet.

Appendix E <Programming Watchdog Timer >

The watchdog timer makes the system auto-reset while it stops to work for a period.

The integrated watchdog timer can be setup as system reset mode by program.

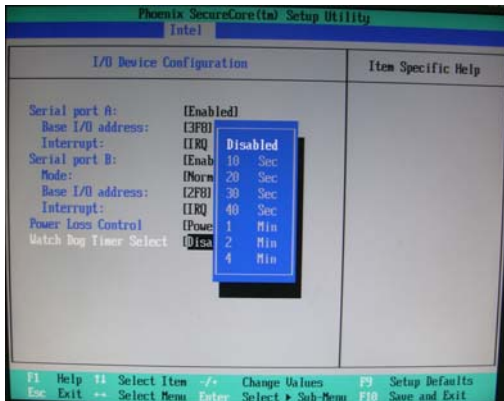

Timeout Value Range

- 1 to 255
- Second or Minute

Program Sample









Watchdog timer setup as system reset with 5 second of timeout

2E, 87	
2E, 87	
2E, 07	
2F, 08	Logical Device 8
2E, 30	Activate
2F, 01	
2E, F5	Set as Second*
2F, 00	
2E, F6	Set as 5
2F, 05	

* Minute: bit 3 = 0; Second: bit 3 = 1

You can select Timer setting in the BIOS, after setting the time options, the system will reset according to the period of your selection.

Appendix F <How to setting RS-232/RS-422/RS-485>

Function	JCSEL2	JCSEL1
IrDA		
RS-422		
RS-485		
RS-232		

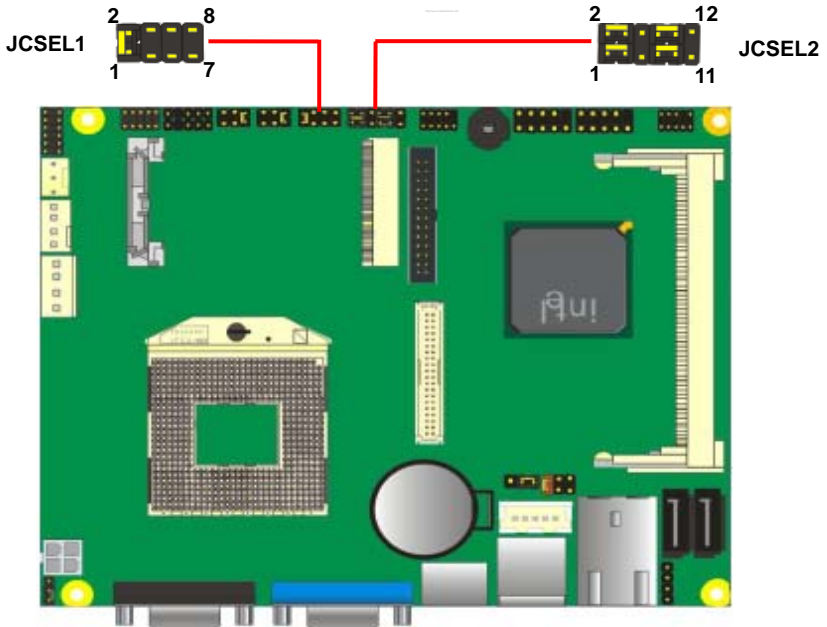

Contact Information

Any advice or comment about our products and service, or anything we can help you please don't hesitate to contact with us. We will do our best to support you for your products, project a business.

Taiwan Commate Computer Inc.

Address	19F, No. 94, Sec. 1, Shin Tai Wu Rd., Shi Chih Taipei Hsien, Taiwan
TEL	+886-2-26963909
FAX	+886-2-26963911
Website	http://www.commell.com.tw
E-Mail	info@commell.com.tw (General Information) tech@commell.com.tw (Technical Support)

Commell is a brand name of Taiwan commate computer Inc.