

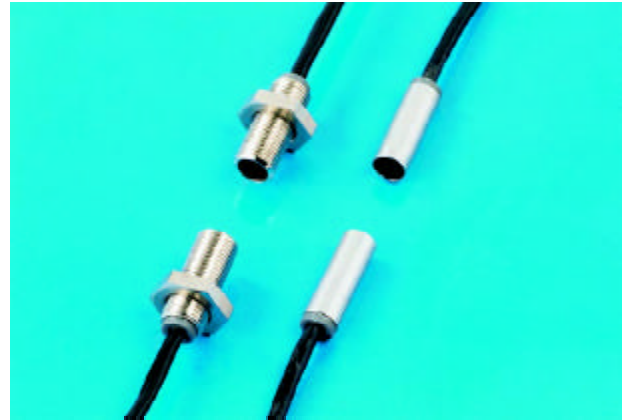



DL40 • DLM50 • DLV60

MINI THROUGH BEAM SENSOR
with separate amplifier

- ▷ long range
- ▷ high excess gain
- ▷ different ways of installation
- ▷ highly flexible connecting cable
- ▷ robust design



<ul style="list-style-type: none"> • Ø 4 mm x 11 mm • Stainless steel • f. gluing a. clamping fixture 	DL40  <small>Actual size</small>
<ul style="list-style-type: none"> • M5 x 0,5 mm x 11 mm • Nickel-plated brass • f. screw-in fixture 	DLM50  <small>Actual size</small>
<ul style="list-style-type: none"> • 6 mm x 6 mm x 12 mm • Nickel-plated brass • f. screw-in fixture 	DLV60  <small>Actual size</small>

GENERAL TECHNICAL DATA

light type	Red 660nm or Infrared 880nm
connection type	PUR-cable with connector
temperature range	-10°C to +55°C
protection class	IP 65

SMALLEST OBJECT and SENSING DISTANCE

sensing distance	1000 mm
smallest object (Ø copper wire)*	0,3 mm

*copper wire of infinite length

DIMENSIONS

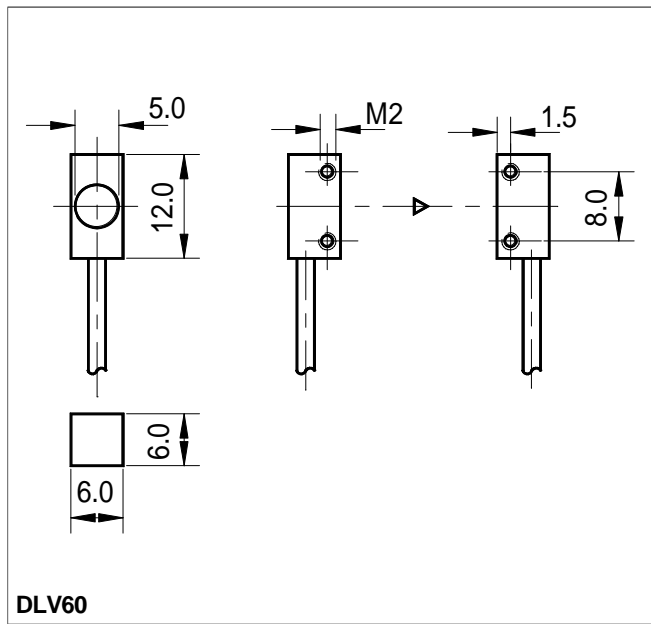
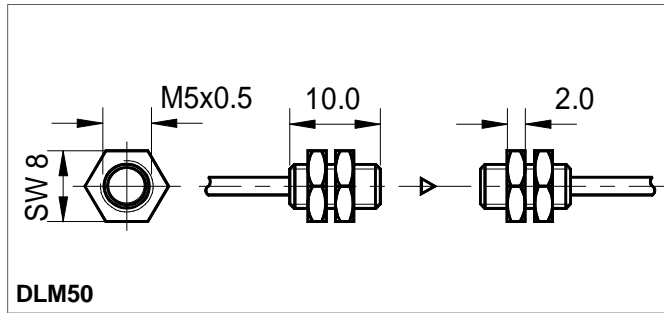
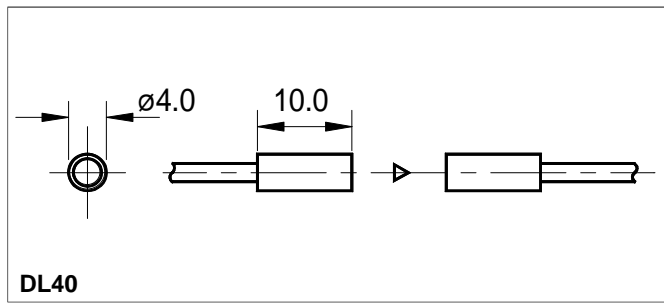

PART DESIGNATION

DL40 □ - □ - □ : □

light type

- R:** Red light
- (blank):** Infrared light

jacket material

- P:** PUR-cable black Ø1,8mm
- F:** highly flexible PUR-cable red Ø1,1mm

cable length (specifications in [m])

- standard length 1m
- special cable length

connector

- 0:** M8 - connector 3 pin, female
- 1:** 719 - Binder connector
(see page *Options and Accessories*)

ORDER EXAMPLE:

DL40R-P-0:1m = DL40 Red light - PUR-cable black - M8, 3 pin female: (cable length 1m x 2)

Please remember, for correct operation, a separate amplifier is required.