

**PLEASE CHECK WWW.MOLEX.COM FOR LATEST PART INFORMATION**

**Part Number:** [0679260311](#)  
**Status:** **Active**  
**Description:** 3.81mm (.150") Pitch Serial ATA IDT Power Receptacle, Gold (Au) Flash, 20AWG, without Latch, with Bump, Lead free

**Documents:**

[3D Model](#) [RoHS Certificate of Compliance \(PDF\)](#)  
[Drawing \(PDF\)](#)

**General**

Product Family	IDT and Solder Connectors
Series	<a href="#">67926</a>
Crimp Quality Equipment	Yes
Product Name	Serial ATA
Use With	<a href="#">67926-0040</a> Feed-to Cover, <a href="#">67926-0041</a> Feed-Through Cover

**Physical**

Circuits (Loaded)	5
Color - Resin	Black
Durability (mating cycles max)	50
Gender	Female
Glow-Wire Compliant	No
Lock to Mating Part	Yes
Material - Metal	Copper Alloy
Material - Plating Mating	Gold
Material - Plating Termination	Tin
Number of Rows	1
Packaging Type	Tray
Panel Mount	No
Pitch - Mating Interface (in)	0.150 In
Pitch - Mating Interface (mm)	3.81 mm
Pitch - Term. Interface (in)	0.150 In
Pitch - Term. Interface (mm)	3.81 mm
Plating min: Mating (µin)	2
Plating min: Mating (µm)	0.05
Plating min: Termination (µin)	75
Plating min: Termination (µm)	1.90
Polarized to Mating Part	Yes
Temperature Range - Operating	-35°C to +85°C
Wire Size AWG	20

**Electrical**

Current - Maximum per Contact	1.5A
Voltage - Maximum	15V DC

**Solder Process Data**

Duration at Max. Process Temperature (seconds)	3
Lead-free Process Capability	Reflow Capable (SMT only)
Max. Cycles at Max. Process Temperature	1
Process Temperature max. C	255

**Material Info**

**Reference - Drawing Numbers**

Sales Drawing	SD-67926-001
---------------	--------------

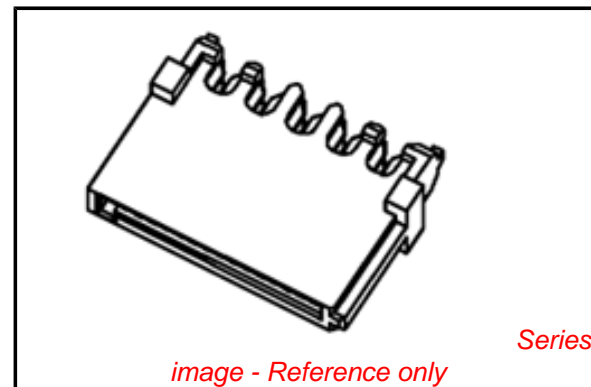

image - Reference only

**EU RoHS**

**ELV and RoHS Compliant**

**REACH SVHC**

Not Reviewed

**Halogen-Free**

**Status**

**Not Halogen-Free**

**China RoHS**



**Need more information on product environmental compliance?**

Email [productcompliance@molex.com](mailto:productcompliance@molex.com)  
 For a multiple part number RoHS Certificate of Compliance, [click here](#)

Please visit the [Contact Us](#) section for any non-product compliance questions.

**Search Parts in this Series**

[67926Series](#)

**Mates With**

[87679](#)

**Application Tooling | FAQ**

*Tooling specifications and manuals are found by selecting the products below. Crimp Height Specifications are then contained in the Application Tooling Specification document.*

**Global**

Description	Product #
Insertion Tool for 3.96mm (.156") Pitch KK® IDT Crimp Terminals	<a href="#">0638133503</a>

This document was generated on 04/16/2010

**PLEASE CHECK [WWW.MOLEX.COM](http://WWW.MOLEX.COM) FOR LATEST PART INFORMATION**

NOTES:

1. MATERIAL:

- HOUSING: THERMAL PLASTIC, G.F., UL94V-0, COLOR: BLACK
- COVER: THERMAL PLASTIC, COLOR: BLACK
- TERMINAL: COPPER ALLOY
- METAL LATCH: STAINLESS STEEL

2. TERMINAL PLATING:

- CONTACT AREA: GOLD PLATED
- IDT TAIL: PLATE TIN, 1.9 MICRONS MINIMUM
- UNDER PLATE: PLATE NICKEL 1.25 MICRONS MINIMUM

3. PACKAGING: TRAY

4. PRODUCT SPECIFICATION REFER TO PS-67490-001

5. ASSEMBLE WITH COVER 679260040/0041 AFTER WIRE TERMINATION

6. MATING PART 87679

7. RECOMMENDED TERMINATING WIRE SIZE: SEE TABLE

8. PRODUCT COMPLIANT TO RoHS DIRECTIVE 2002/95/EC AND ELV DIRECTIVE 2000/53/EC

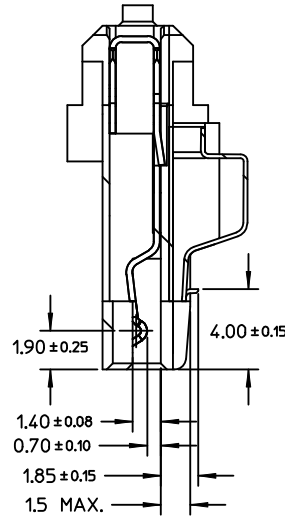
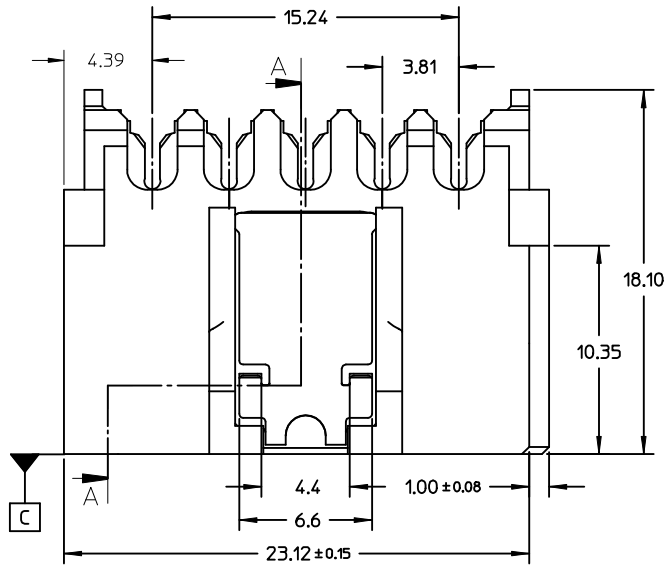

SECTION A-A

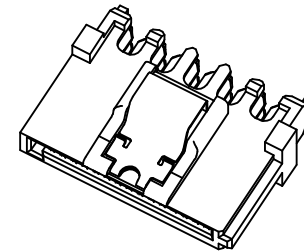

WITH LATCH TYPE

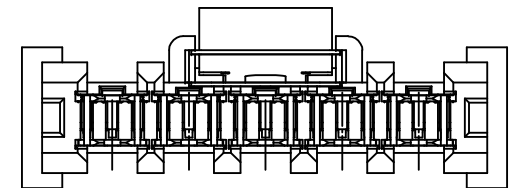
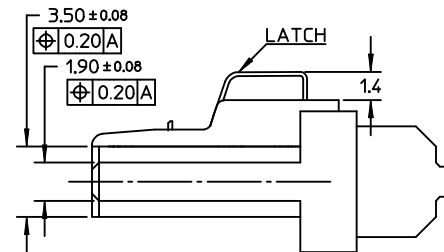
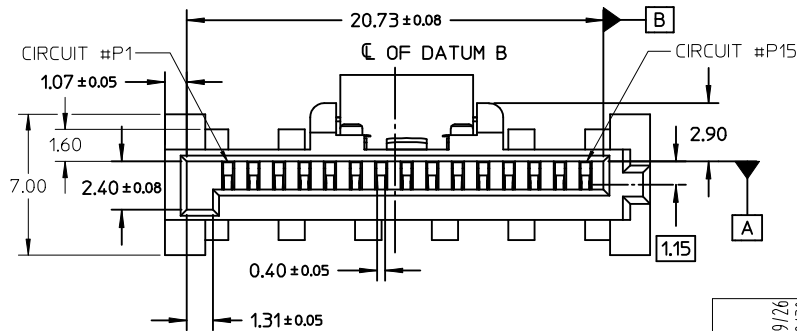

REVISED EC NO: SH2009-0098 DRW: CWTANG 2008/09/26 CHK: XJSONG 2008/09/30 APPR: HWANG 2008/11/01 DESCRIPTION REV	QUALITY SYMBOLS	GENERAL TOLERANCES (UNLESS SPECIFIED)	DIMENSION STYLE	SCALE	DESIGN UNITS	THIRD ANGLE PROJECTION	
	▽=0 ◻=0	mm    INCH 4 PLACES ± --- ± --- 3 PLACES ± --- ± --- 2 PLACES ± 0.25 ± --- 1 PLACE ± 0.3 ± --- ANGULAR ± 1°	MM ONLY	4:1	METRIC		
		DRAFT WHERE APPLICABLE MUST REMAIN WITHIN DIMENSIONS	DRAWN BY DATE GRATE MA 2004/01/17 CHECKED BY DATE YAJUN 2004/01/17 APPROVED BY DATE SAM 2004/01/17	TITLE	SERIAL ATA POWER CONNECTOR IDT TYPE		
			MATERIAL NO. SEE CHART SIZE A3	DOCUMENT NO. SD-67926-001	MOLEX INCORPORATED SHEET NO. 1 OF 3		

10 9 8 7 6 5 4 3 2 1

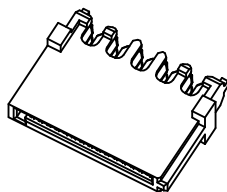
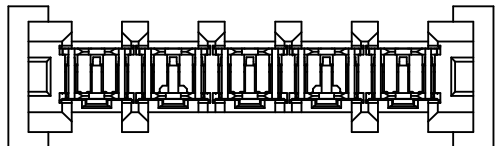

WITHOUT LATCH TYPE

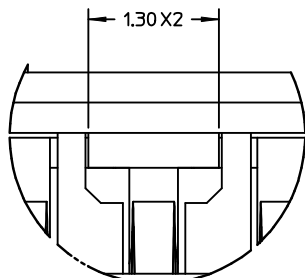
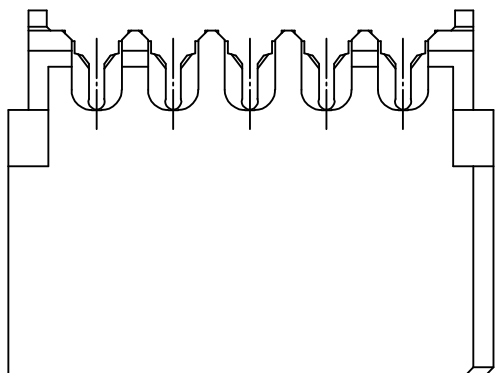

Detail2

SCALE 20:1

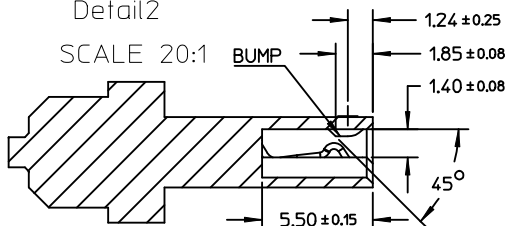

SECTION B-B

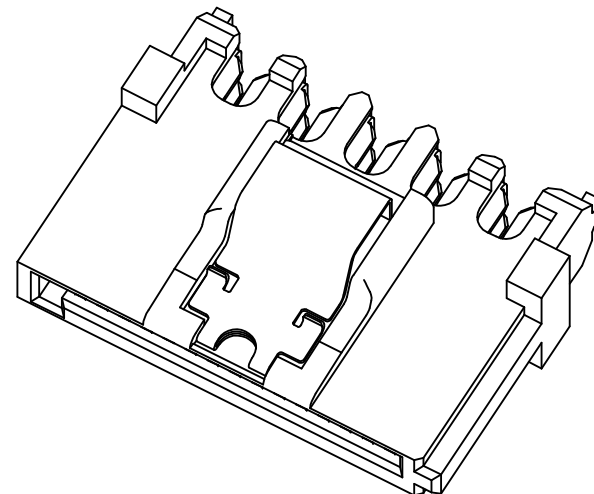
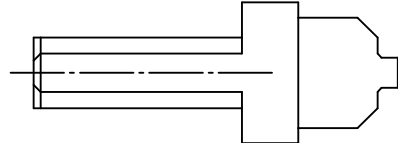

See Detail2

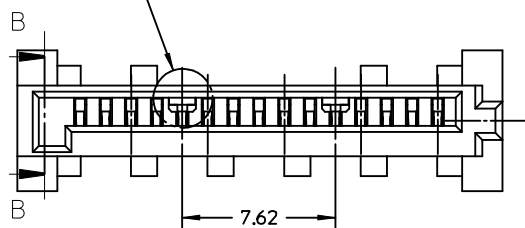

NOTES:  
OTHER INFORMATION REFER TO SHEET 1

REVISED EC NO: SH2009-0098 G DRWIN: CWTANG CHKD: XJSONG APPR: HWANG	DESCRIPTION REV	QUALITY SYMBOLS ▽=0 ◻=0	GENERAL TOLERANCES (UNLESS SPECIFIED)		DIMENSION STYLE MM ONLY	SCALE 4:1	DESIGN UNITS METRIC	THIRD ANGLE PROJECTION	
			mm	INCH	DRAWN BY GRATE MA	DATE 2004/01/17	TITLE SERIAL ATA POWER CONNECTOR IDT TYPE		
			4 PLACES ± ---	± ---	CHECKED BY YA JUN	DATE 2004/01/17	MATERIAL NO. SAM		
			3 PLACES ± ---	± ---	APPROVED BY SAM	DATE 2004/01/17	DOCUMENT NO. SD-67926-001		
		2 PLACES ± 0.25	± ---	DRAFT WHERE APPLICABLE MUST REMAIN WITHIN DIMENSIONS		SEE CHART		SHEET NO. 2 OF 3	
		1 PLACE ± 0.3	± ---	ANGULAR ± 1 °		THIS DRAWING CONTAINS INFORMATION THAT IS PROPRIETARY TO MOLEX INCORPORATED AND SHOULD NOT BE USED WITHOUT WRITTEN PERMISSION			

9 8 7 6 5 4 3 2 1

P/N	RECOMMENDED WIRE SIZE	PLATE TYPE	REMARK
67926-0001	18AWG	GOLD FLASH	WITH LATCH,WITHOUT BUMP
67926-0301	20AWG		
67926-0401	22AWG		
67926-0002	18AWG	0.76 MICRON GOLD PLATED	
67926-0302	20AWG		
67926-0402	22AWG		
67926-0005	18AWG	0.38 MICRON GOLD PLATED	
67926-0305	20AWG		
67926-0405	22AWG		
67926-0021	18AWG	GOLD FLASH	WITH LATCH,WITH BUMP
67926-0321	20AWG		
67926-0421	22AWG		
67926-0022	18AWG	0.76 MICRON GOLD PLATED	
67926-0322	20AWG		
67926-0422	22AWG		
67926-0025	18AWG	0.38 MICRON GOLD PLATED	
67926-0325	20AWG		
67926-0425	22AWG		
67926-0011	18AWG	GOLD FLASH	WITHOUT LATCH,WITH BUMP
67926-0311	20AWG		
67926-0411	22AWG		
67926-0012	18AWG	0.76 MICRON GOLD PLATED	
67926-0312	20AWG		
67926-0412	22AWG		
67926-0015	18AWG	0.38 MICRON GOLD PLATED	
67926-0315	20AWG		
67926-0415	22AWG		

REVISED EC NO: SH2009-0098 DRWN: CWTANG CHKD: XJSONG APPR: HWANG	2008/09/26 2008/09/30 2008/11/01	DESCRIPTION REV	QUALITY SYMBOLS	GENERAL TOLERANCES (UNLESS SPECIFIED)	DIMENSION STYLE	SCALE	DESIGN UNITS	THIRD ANGLE PROJECTION
			$\nabla=0$ $\square=0$	mm INCH	MM ONLY	4:1	METRIC	
			4 PLACES ± --- ± --- 3 PLACES ± --- ± --- 2 PLACES ± 0.25 ± --- 1 PLACE ± 0.3 ± --- ANGULAR ± 1 °	DRAWN BY DATE GRATE MA 2004/01/17 CHECKED BY DATE YA JUN 2004/01/17 APPROVED BY DATE SAM 2004/01/17	TITLE			
			DRAFT WHERE APPLICABLE MUST REMAIN WITHIN DIMENSIONS	MATERIAL NO. SEE CHART	DOCUMENT NO. SD-67926-001	SERIAL ATA POWER CONNECTOR IDT TYPE MOLEX INCORPORATED		
		SIZE	THIS DRAWING CONTAINS INFORMATION THAT IS PROPRIETARY TO MOLEX INCORPORATED AND SHOULD NOT BE USED WITHOUT WRITTEN PERMISSION			SHEET NO.		
		A3				3 OF 3		