

1ST112WS

SILICON EPITAXIAL PLANAR SWITCHING DIODES

PINNING

PIN	DESCRIPTION
1	Cathode
2	Anode

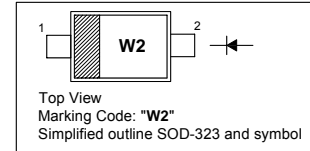

Absolute Maximum Ratings ($T_a = 25\text{ }^\circ\text{C}$)

Parameter	Symbol	Value	Unit
Peak Reverse Voltage	V_{RM}	40	V
Reverse Voltage	V_R	40	V
Average Forward Current	$I_{F(AV)}$	200	mA
Peak Forward Current	I_{FM}	600	mA
Non-Repetitive Peak Forward Surge Current ($t = 1\text{ s}$)	I_{FSM}	1	A
Junction Temperature	T_j	150	$^\circ\text{C}$
Storage Temperature Range	T_{stg}	- 55 to + 150	$^\circ\text{C}$

Characteristics at $T_a = 25\text{ }^\circ\text{C}$

Parameter	Symbol	Max.	Unit
Forward Voltage at $I_F = 200\text{ mA}$	V_F	1.1	V
Reverse Current at $V_R = 15\text{ V}$ at $V_R = 35\text{ V}$	I_R	50 500	nA
Total Capacitance at $V_R = 0\text{ V}$, $f = 1\text{ MHz}$	C_T	4	pF
Reverse Recovery Time at $V_R = 6\text{ V}$, $I_F = 10\text{ mA}$, $I_{rr} = 0.1 \cdot I_R$, $R_L = 100\ \Omega$	t_{rr}	10	ns

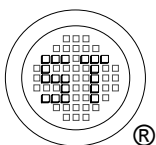

SEMTECH ELECTRONICS LTD.

(Subsidiary of Sino-Tech International Holdings Limited, a company listed on the Hong Kong Stock Exchange, Stock Code: 724)

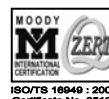

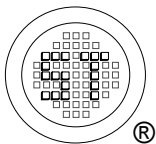
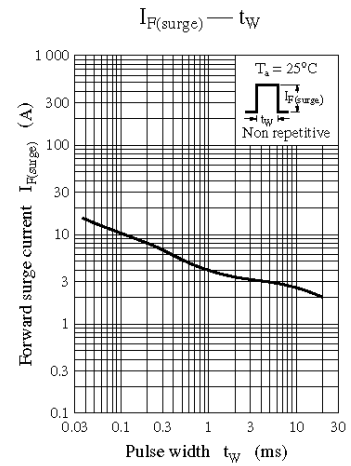
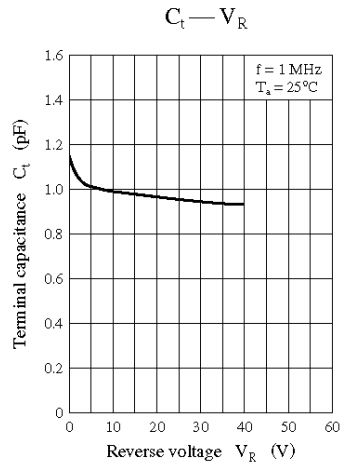
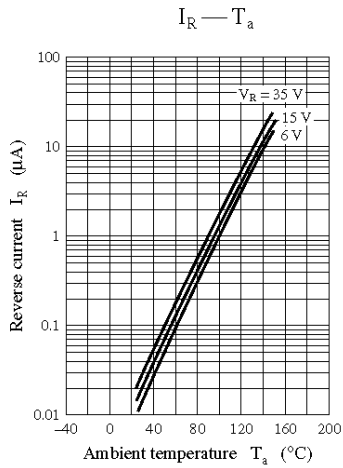
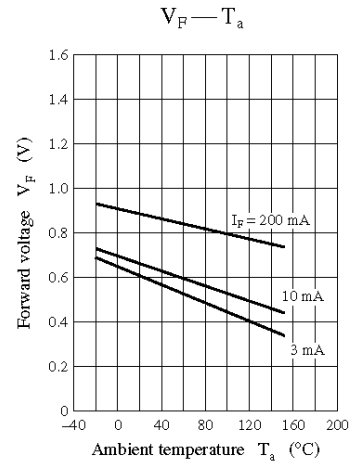
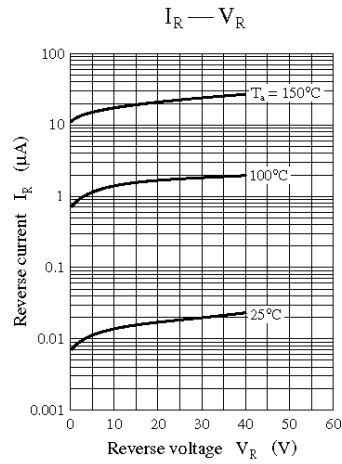
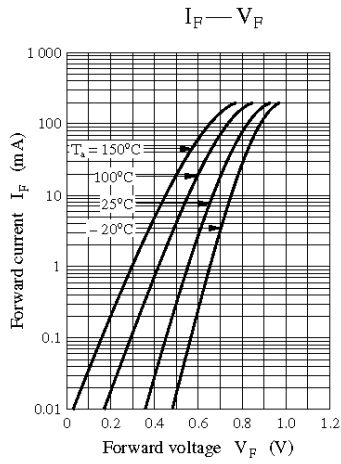

SEMTECH ELECTRONICS LTD.
 (Subsidiary of Sino-Tech International Holdings Limited, a company listed on the Hong Kong Stock Exchange, Stock Code: 724)

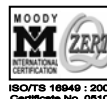

1ST112WS

PACKAGE OUTLINE

Plastic surface mounted package; 2 leads

SOD-323

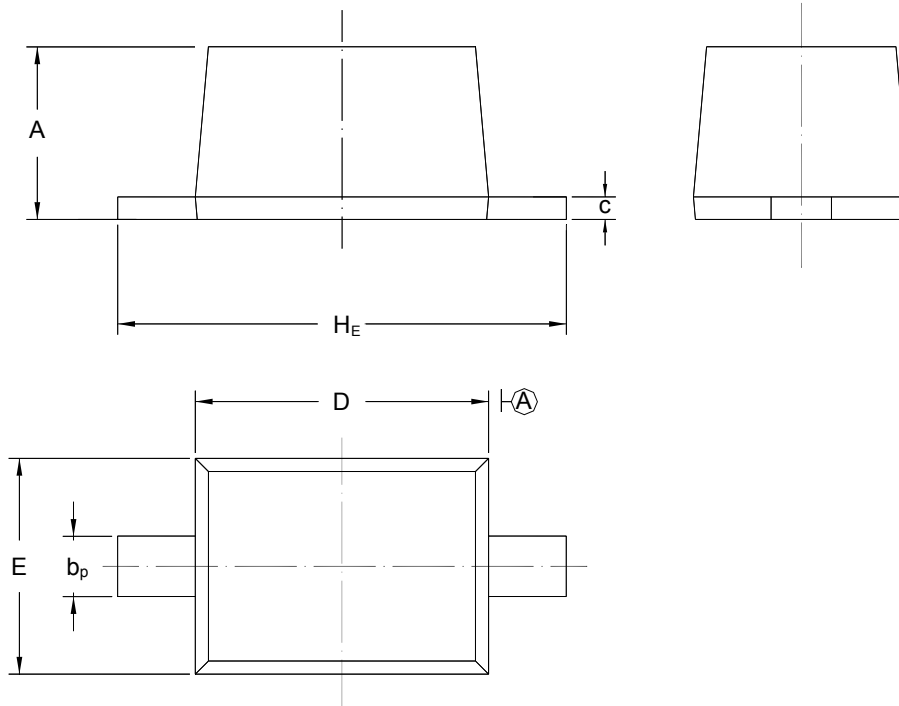

UNIT	A	b _p	C	D	E	H _E
mm	1.10 0.80	0.40 0.25	0.15 0.00	1.80 1.60	1.35 1.15	2.80 2.30

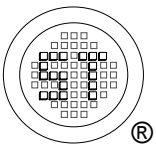

SEMTECH ELECTRONICS LTD.
 (Subsidiary of Sino-Tech International Holdings Limited, a company listed on the Hong Kong Stock Exchange, Stock Code: 724)

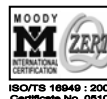

Dated : 07/04/2009