



Micro Commercial Components
 20736 Marilla Street Chatsworth
 CA 91311
 Phone: (818) 701-4933
 Fax: (818) 701-4939

BAS40-04T
BAS40-05T
BAS40-06T

Features

- Pow Dissipation PD=150mW Tamb=25°C
- Forward Current I_F=200mA
- Reverse Voltage V_R=40V
- Epoxy meets UL 94 V-0 flammability rating
- Moisture Sensitivity Level 1

Maximum Ratings

- Operating Temperature: -65°C to +150°C
- Storage Temperature: -65°C to +150°C

Electrical Characteristics @ 25°C Unless Otherwise Specified

Reverse Breakdown Voltage	V _{(BR)R}	40V	I _R =10μA
Maximum Instantaneous Forward Voltage	V _F	380mV 1000mV	I _{FM} = 1mA; I _{FM} = 40mA;
Maximum DC Reverse Current At Rated DC Blocking Voltage	I _R	200nA	V _R =30Volts
Total Capacitance	C _T	5pF	Measured at 1.0MHz, V _R =0V
Reverse Recovery Time	T _{rr}	5nS	I _F =I _R =10mA, I _{rr} =1mA,R _L =100Ω

150mW 40Volt
Plastic-Encapsulate
Diode

SOT-523

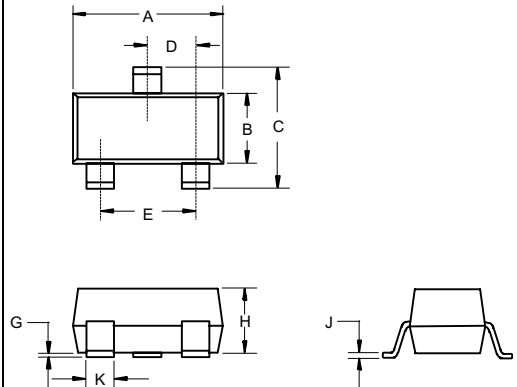

DIM	DIMENSIONS				NOTE
	INCHES		MM		
A	.059	.067	1.50	1.70	
B	.030	.033	0.75	0.85	
C	.057	.069	1.45	1.75	
D	.020 Nominal		0.50Nominal		
E	.035	.043	0.90	1.10	
G	.000	.004	.000	.100	
H	.028	.031	.70	0.80	
J	.004	.008	.100	.200	
K	.010	.014	.25	.35	

BAS40T/-04T/-05T/-06T

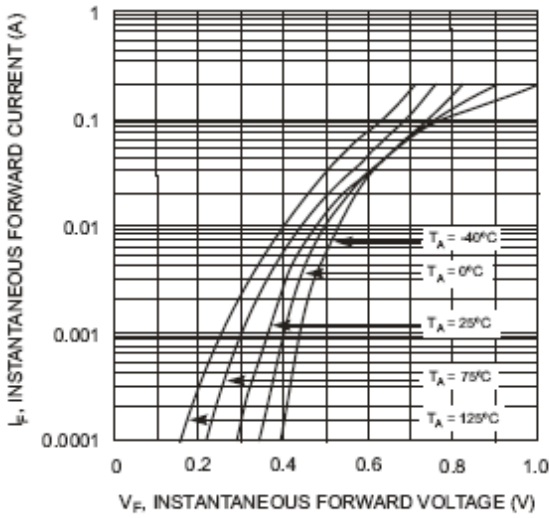

Fig. 1 Typical Forward Voltage

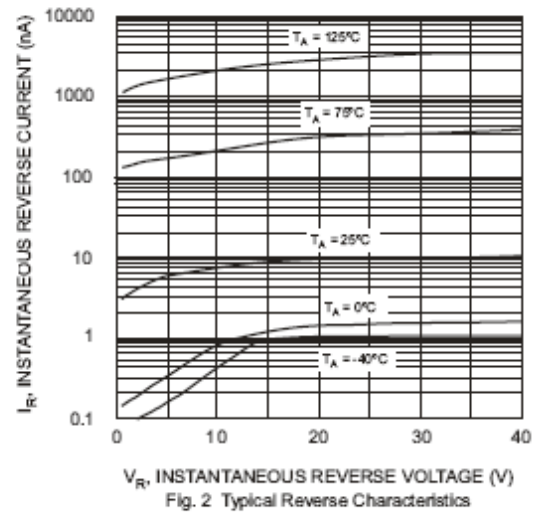

Fig. 2 Typical Reverse Characteristics

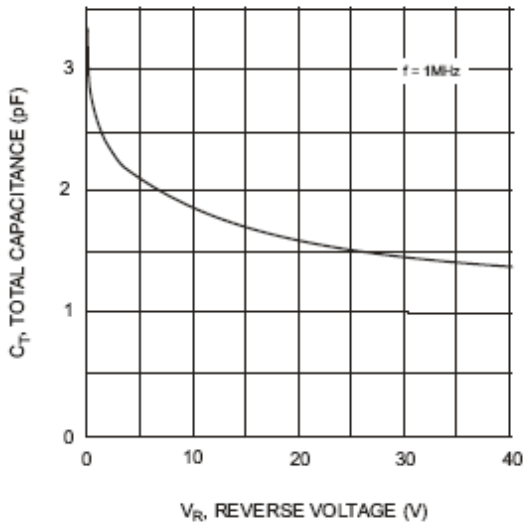

Fig. 3 Typical Capacitance

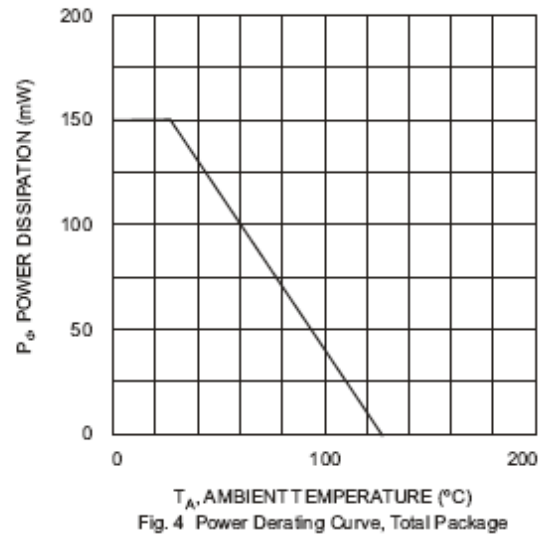
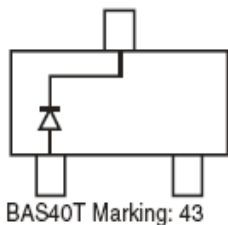
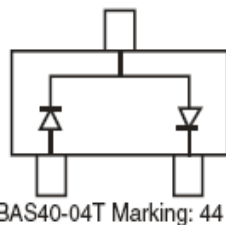

Fig. 4 Power Derating Curve, Total Package

Marking:



BAS40T Marking: 43



BAS40-04T Marking: 44

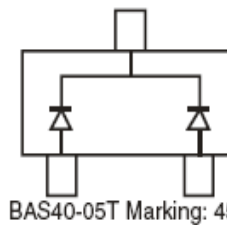

BAS40-05T Marking: 45

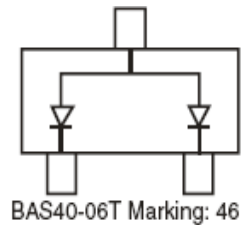

BAS40-06T Marking: 46



Micro Commercial Components

Ordering Information :

Device	Packing
Part Number-TP	Tape&Reel: 3Kpcs/Reel

*****IMPORTANT NOTICE*****

Micro Commercial Components Corp. reserves the right to make changes without further notice to any product herein to make corrections, modifications , enhancements , improvements , or other changes . **Micro Commercial Components Corp .** does not assume any liability arising out of the application or use of any product described herein; neither does it convey any license under its patent rights ,nor the rights of others . The user of products in such applications shall assume all risks of such use and will agree to hold **Micro Commercial Components Corp .** and all the companies whose products are represented on our website, harmless against all damages.

*****LIFE SUPPORT*****

MCC's products are not authorized for use as critical components in life support devices or systems without the express written approval of Micro Commercial Components Corporation.

*****CUSTOMER AWARENESS*****

Counterfeiting of semiconductor parts is a growing problem in the industry. Micro Commercial Components (MCC) is taking strong measures to protect ourselves and our customers from the proliferation of counterfeit parts. MCC strongly encourages customers to purchase MCC parts either directly from MCC or from Authorized MCC Distributors who are listed by country on our web page cited below. Products customers buy either from MCC directly or from Authorized MCC Distributors are genuine parts, have full traceability, meet MCC's quality standards for handling and storage. **MCC will not provide any warranty coverage or other assistance for parts bought from Unauthorized Sources.** MCC is committed to combat this global problem and encourage our customers to do their part in stopping this practice by buying direct or from authorized distributors.