

GaAs MMIC PASSIVE FREQUENCY DOUBLER, 6 - 12 GHz INPUT

Typical Applications

The HMC205 is suitable for:

- Wireless Local Loop
- LMDS, VSAT, and Point-to-Point Radios
- Test Equipment

Features

- Conversion Loss: 12 to 17 dB
- Fo, 3Fo, 4Fo Isolation: 32 dB
- Passive: No Bias Required

Functional Diagram

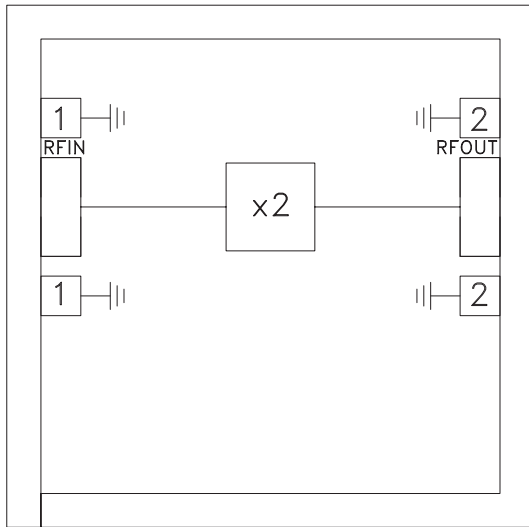

General Description

The HMC205 is a passive miniature frequency doubler in a MMIC die. Suppression of undesired fundamental and higher order harmonics is 32 dB typical with respect to input signal level. The doubler utilizes the same GaAs Schottky diode/balun technology found in Hittite MMIC mixers. It features small size, no DC bias, and no measurable additive phase noise onto the multiplied signal.

Electrical Specifications, $T_A = +25^\circ \text{C}$, As a Function of Drive Level

Parameter	Input = +10 dBm			Input = +12 dBm			Input = +15 dBm			Units
	Min.	Typ.	Max.	Min.	Typ.	Max.	Min.	Typ.	Max.	
Frequency Range, Input	7.0 - 12.0			6.0 - 12.0			6.0 - 12.0			GHz
Frequency Range, Output	14.0 - 24.0			12.0 - 24.0			12.0 - 24.0			GHz
Conversion Loss		18	21		17	20		15	18	dB
FO Isolation (with respect to input level)				28	32					dB
3FO Isolation (with respect to input level)				36	40					dB
4FO Isolation (with respect to input level)				26	32					dB

GaAs MMIC PASSIVE FREQUENCY DOUBLER, 6 - 12 GHz INPUT

Conversion Gain vs. Temperature @ +15 dBm Drive Level

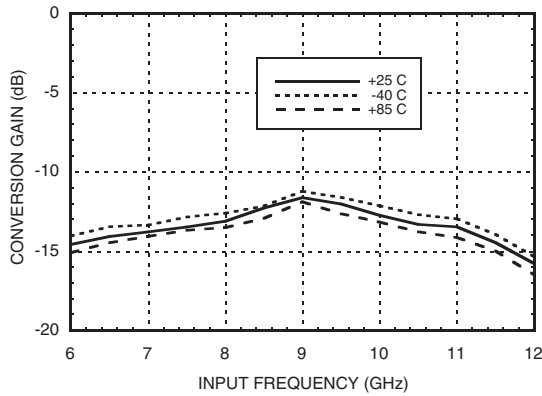

Isolation @ +15 dBm Drive Level*

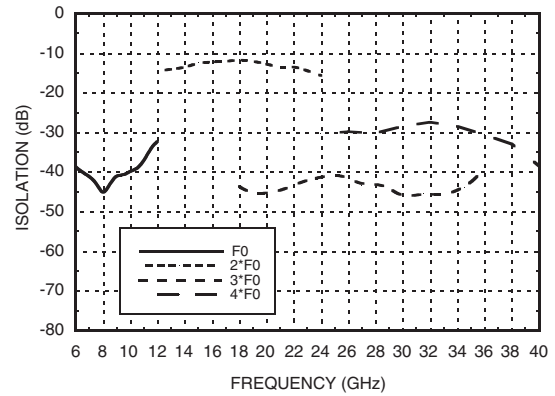

*With respect to input level

Input Return Loss vs. Drive Level

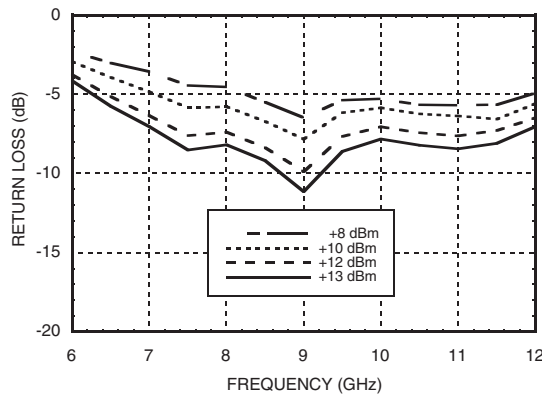

Output Return Loss for Several Input Frequencies

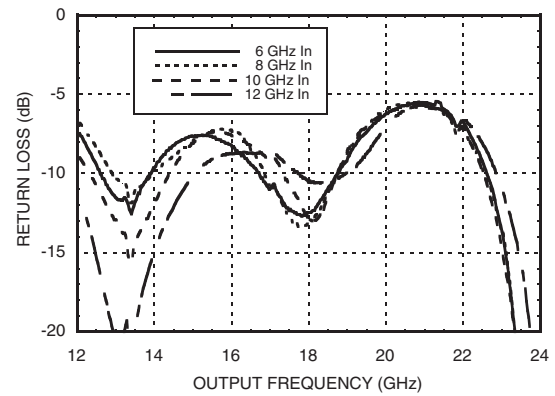

GaAs MMIC PASSIVE FREQUENCY DOUBLER, 6 - 12 GHz INPUT

Conversion Gain @ 25°C vs. Drive Level

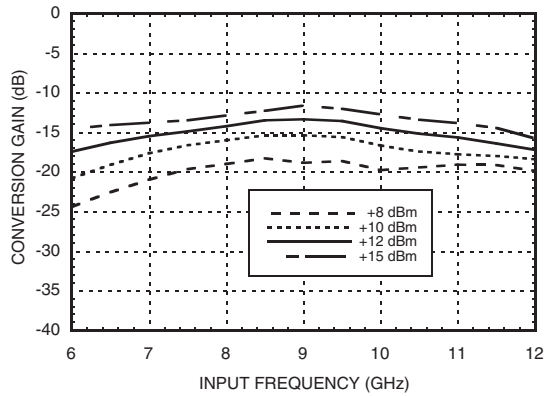

Output Return Loss with 6 GHz Input

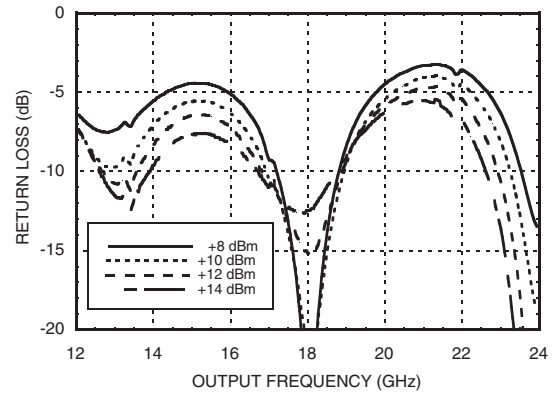

Conversion Gain @ -55°C vs. Drive Level

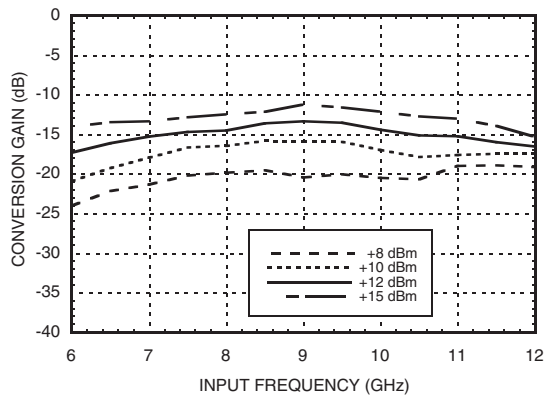

Output Return Loss with 10 GHz Input

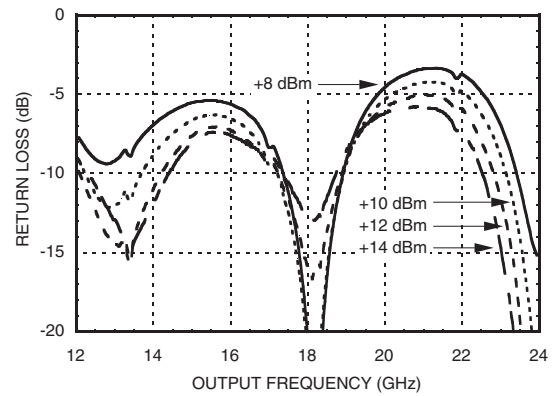

Conversion Gain @ +85°C vs. Drive Level

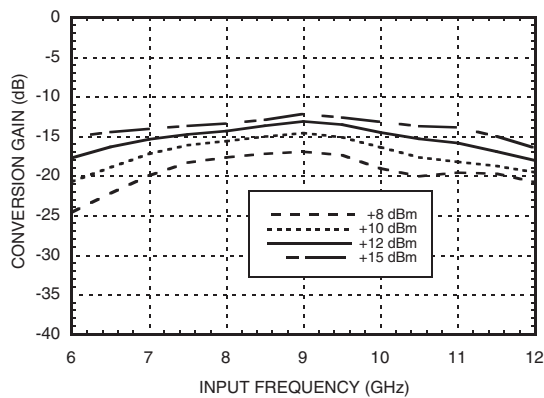

Output Return Loss with 12 GHz Input

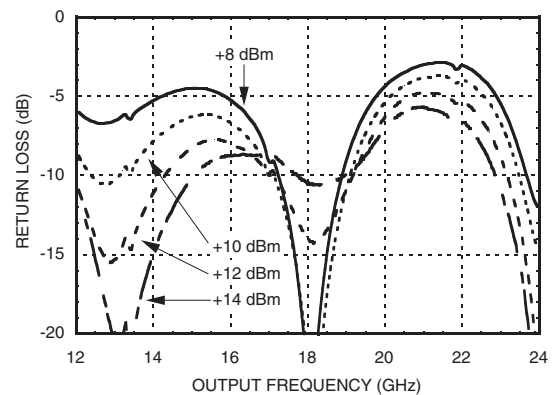

**GaAs MMIC PASSIVE FREQUENCY
DOUBLER, 6 - 12 GHz INPUT**

Absolute Maximum Ratings

Input Drive	+27 dBm
Storage Temperature	-65 to +150 °C
Operating Temperature	-55 to +85 °C



ELECTROSTATIC SENSITIVE DEVICE
OBSERVE HANDLING PRECAUTIONS

Outline Drawing

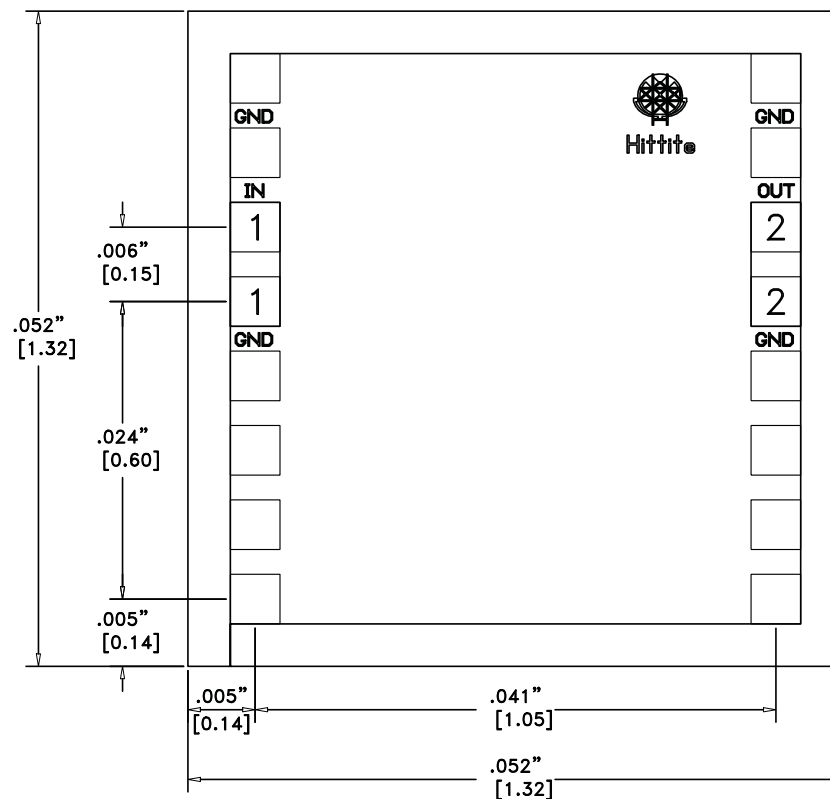

Die Packaging Information ^[1]

Standard	Alternate
WP-2 (Waffle Pack)	[2]



[1] Refer to the "Packaging Information" section for die packaging dimensions.

[2] For alternate packaging information contact Hittite Microwave Corporation.

NOTES:

1. ALL DIMENSIONS ARE IN INCHES [MM]
2. BOND PADS ARE .004" SQUARE
3. TYPICAL BOND PAD SPACING CENTER TO CENTER IS .006" EXCEPT AS SHOWN.
4. BACKSIDE METALLIZATION: GOLD
5. BACKSIDE METAL IS GROUND.
6. BOND PAD METALLIZATION: GOLD

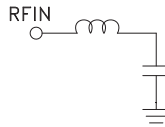
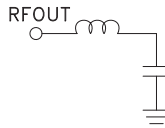
**GaAs MMIC PASSIVE FREQUENCY
 DOUBLER, 6 - 12 GHz INPUT**
Pad Description

Pad Number	Function	Description	Interface Schematic
1	RFIN	DC coupled and matched to 50 Ohm.	
2	RFOUT	DC coupled and matched to 50 Ohm.	
Die Bottom	GND	Die bottom must be connected to RF/DC ground.	

**GaAs MMIC PASSIVE FREQUENCY
DOUBLER, 6 - 12 GHz INPUT**

Handling Precautions

Follow these precautions to avoid permanent damage.

Storage: All bare die are placed in either Waffle or Gel based ESD protective containers, and then sealed in an ESD protective bag for shipment. Once the sealed ESD protective bag has been opened, all die should be stored in a dry nitrogen environment.

Cleanliness: Handle the chips in a clean environment. DO NOT attempt to clean the chip using liquid cleaning systems.

Static Sensitivity: Follow ESD precautions to protect against ESD strikes.

Transients: Suppress instrument and bias supply transients while bias is applied. Use shielded signal and bias cables to minimize inductive pick-up.

General Handling: Handle the chip along the edges with a vacuum collet or with a sharp pair of bent tweezers. The surface of the chip may have fragile air bridges and should not be touched with vacuum collet, tweezers, or fingers.

Mounting

The chip is back-metallized and can be die mounted with AuSn eutectic preforms or with electrically conductive epoxy. The mounting surface should be clean and flat.

Epoxy Die Attach:

Apply a minimum amount of epoxy to the mounting surface so that a thin epoxy fillet is observed around the perimeter of the chip once it is placed into position.

Cure epoxy per the manufacturer's schedule.

Wire Bonding

Ball or wedge bond with 1.0 diameter pure gold wire. Thermosonic wirebonding with a nominal stage temperature of 150 °C and a ball bonding force of 40 to 50 grams or wedge bonding force of 18 to 22 grams is recommended. Use the minimum level of ultrasonic energy to achieve reliable wirebonds. Wirebonds should be started on the chip and terminated on the package. RF bonds should be as short as possible.