

# IDD 10U SERIES

DC - DC CONVERTER  
10W SINGLE & DUAL OUTPUT



## FEATURES

- EFFICIENCY UP TO 89%
- 2:1 WIDE INPUT RANGE
- I/O ISOLATION
- INPUT Pi FILTER
- SHORT CIRCUIT PROTECTION
- HIGH PERFORMANCE
- UL/cUL/TUV/CE
- 2 YEARS WARRANTY



EN 60950-1

## MODEL LIST

MODEL NO.	INPUT VOLTAGE	INPUT CURRENT (typ.)   (max.)		OUTPUT WATTAGE	OUTPUT VOLTAGE	OUTPUT CURRENT	EFF. (min.)	EFF. (typ.)	CAPACITOR LOAD (max.)
-----------	---------------	-------------------------------	--	----------------	----------------	----------------	-------------	-------------	-----------------------

### Single Output Models

IDD10 - 03S1U	9~18 VDC	1.00 A	1.34 A	10 WATTS	+ 3.3 VDC	3000 mA	81%	83%	3500 $\mu$ F
IDD10 - 05S1U	9~18 VDC	1.00 A	1.34 A	10 WATTS	+ 5 VDC	2000 mA	83%	85%	3500 $\mu$ F
IDD10 - 12S1U	9~18 VDC	0.95 A	1.30 A	10 WATTS	+ 12 VDC	830 mA	87%	89%	1000 $\mu$ F
IDD10 - 15S1U	9~18 VDC	0.95 A	1.30 A	10 WATTS	+ 15 VDC	670 mA	87%	89%	1000 $\mu$ F
IDD10 - 03S2U	18~36 VDC	0.50 A	0.67 A	10 WATTS	+ 3.3 VDC	3000 mA	81%	83%	3500 $\mu$ F
IDD10 - 05S2U	18~36 VDC	0.49 A	0.67 A	10 WATTS	+ 5 VDC	2000 mA	83%	85%	3500 $\mu$ F
IDD10 - 12S2U	18~36 VDC	0.47 A	0.64 A	10 WATTS	+ 12 VDC	830 mA	87%	89%	1000 $\mu$ F
IDD10 - 15S2U	18~36 VDC	0.48 A	0.64 A	10 WATTS	+ 15 VDC	670 mA	87%	89%	1000 $\mu$ F
IDD10 - 03S3U	35~75 VDC	0.25 A	0.35 A	10 WATTS	+ 3.3 VDC	3000 mA	81%	83%	3500 $\mu$ F
IDD10 - 05S3U	35~75 VDC	0.25 A	0.35 A	10 WATTS	+ 5 VDC	2000 mA	83%	85%	3500 $\mu$ F
IDD10 - 12S3U	35~75 VDC	0.23 A	0.35 A	10 WATTS	+ 12 VDC	830 mA	87%	89%	1000 $\mu$ F
IDD10 - 15S3U	35~75 VDC	0.23 A	0.35 A	10 WATTS	+ 15 VDC	670 mA	87%	89%	1000 $\mu$ F

### Dual Output Models

IDD10 - 05D1U	9~18 VDC	1.00 A	1.36 A	10 WATTS	$\pm$ 5 VDC	$\pm$ 1000 mA	83%	85%	$\pm$ 3500 $\mu$ F
IDD10 - 12D1U	9~18 VDC	0.96 A	1.33 A	10 WATTS	$\pm$ 12 VDC	$\pm$ 420 mA	86%	88%	$\pm$ 1000 $\mu$ F
IDD10 - 15D1U	9~18 VDC	0.95 A	1.33 A	10 WATTS	$\pm$ 15 VDC	$\pm$ 340 mA	87%	89%	$\pm$ 1000 $\mu$ F
IDD10 - 05D2U	18~36 VDC	0.49 A	0.66 A	10 WATTS	$\pm$ 5 VDC	$\pm$ 1000 mA	84%	86%	$\pm$ 3500 $\mu$ F
IDD10 - 12D2U	18~36 VDC	0.47 A	0.66 A	10 WATTS	$\pm$ 12 VDC	$\pm$ 420 mA	87%	89%	$\pm$ 1000 $\mu$ F
IDD10 - 15D2U	18~36 VDC	0.47 A	0.66 A	10 WATTS	$\pm$ 15 VDC	$\pm$ 340 mA	87%	89%	$\pm$ 1000 $\mu$ F
IDD10 - 05D3U	35~75 VDC	0.24 A	0.34 A	10 WATTS	$\pm$ 5 VDC	$\pm$ 1000 mA	84%	86%	$\pm$ 3500 $\mu$ F
IDD10 - 12D3U	35~75 VDC	0.23 A	0.34 A	10 WATTS	$\pm$ 12 VDC	$\pm$ 420 mA	87%	89%	$\pm$ 1000 $\mu$ F
IDD10 - 15D3U	35~75 VDC	0.23 A	0.34 A	10 WATTS	$\pm$ 15 VDC	$\pm$ 340 mA	87%	89%	$\pm$ 1000 $\mu$ F

### SPECIFICATION

All Specifications Typical At Nominal Line, Full Load, 25°C Unless Otherwise Noticed

#### GENERAL

Characteristics	Conditions	min.	typ.	max.	unit
Switching frequency	Vi nom, Io nom		200		KHz
Isolation voltage	Input - Output	1500			VDC
Isolation resistance	Input - Output, @ 500VDC	100			MΩ
Isolation capacitance	100KHz / 1V			1000	PF
Ambient temperature	Operating at Vi nom, Io nom	-40		+ 71	°C
Case temperature	Operating at Vi nom, Io nom			+ 100	°C
Derating	Vi nom	See derating curve			
Storage temperature	Non operational	-40		+ 100	°C
Relative humidity	Vi nom, Io nom	20		95	% RH
Temperature coefficient	Vi nom, Io min			± 0.02	% / °C
Dimension		L50.8 x W25.4 x H10.16			mm
MTBF	Bellcore issue 6@40°C, GB		1284000		Hours
Cooling	Free air convection				

#### INPUT SPECIFICATIONS

Characteristics	Conditions	min.	typ.	max.	unit
Input voltage range	Ta min ... Ta max, Io nom	9	12	18	VDC
		18	24	36	VDC
		35	48	75	VDC
No load input current	Vi nom, Io = 0	12V models		25	mA
		24V models		20	mA
		48V models		15	mA
Input voltage w/o damage	Io nom	12V models		20	VDC
		24V models		40	VDC
		48V models		80	VDC
Startup voltage	Io nom	12V models	8.5		VDC
		24V models	16		VDC
		48V models	33		VDC
Input filter	Pi type				

#### OUTPUT SPECIFICATIONS

Characteristics	Conditions	min.	typ.	max.	unit
Output voltage accuracy	Vi nom, Io nom			± 2	%
Minimum load	Vi nom single output models	0			%
	Vi nom dual output models (each output)	10			%
Line regulation	Io nom, Vi min ... Vi max			± 1	%
Load regulation	Vi nom, Io 0 ... Io nom, single output models			± 2	%
	Vi nom, Io min ... Io nom, dual output models			± 5	%
Cross regulation (Dual model)	Asymmetrical load 10% - 100% FL			± 5	%
Startup time	Vi nom, Io nom			30	ms
Transient recovery time	Vi nom, I ~ 0.5 Io nom			500	μs
Ripple & noise *	Vi nom, Io nom, BW = 20MHz	3.3V & 5V models		100	mV
		12V, 15V & dual		150	mV
Efficiency	Vi nom, Io nom, Po / Pi	Up to 89%, See model list and efficiency curve			

\* Note : Output must be added 0.1 μF / 35V capacitor when application.

### SPECIFICATION

All Specifications Typical At Nominal Line, Full Load, 25°C Unless Otherwise Noticed

### CONTROL AND PROTECTION

Input reversed	Shunt diode built in, external fuse recommended (12Vin: 1.5A, 24Vin: 1A, 48Vin: 1A)
Output short circuit	Current limited (Auto-recovery)
Rated over load protection	110%min....160%max

### APPROVALS AND STANDARD

UL/cUL	UL 60950-1 Recognized
TUV	EN 60950-1, CB scheme
CE	EN 61204-3, EN 55022 Class A, EN 61000-4-2, EN61000-4-3, EN61000-4-4, EN61000-4-6
Vibration	meet IEC 60068-2-6 (10-500 Hz, 2G, along X, Y, Z each Axis, 60 min for each Axis)

### PHYSICAL CHARACTERISTICS

Case size	50.8 x 25.4 x 10.16 mm (2 x 1 x 0.4 inches)
Case material	Plastic base / Metal case
Weight	35 g
Patting material	Silicone

### MECHANISM & PIN CONFIGURATION

mm [inch]

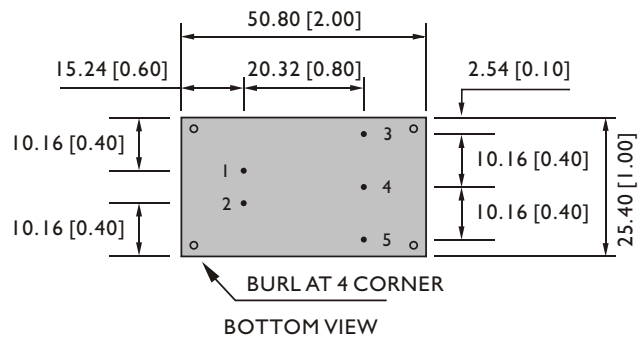
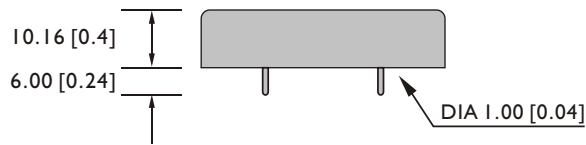

GENERAL TOLERANCE	
0.00[0.00] - 30.00[1.18]	±0.30[0.01]
30.00[1.18] - 120.00[4.72]	±0.50[0.02]

### PIN ASSIGNMENT

#### GENERAL

PIN NO.	1	2	3	4	5
SINGLE	Vi+	Vi-	Vo+	NO PIN	Vo-
DUAL	Vi+	Vi-	Vo+	com	Vo-

### CIRCUIT SCHEMATIC

• Block diagram for IDD10U series with single output

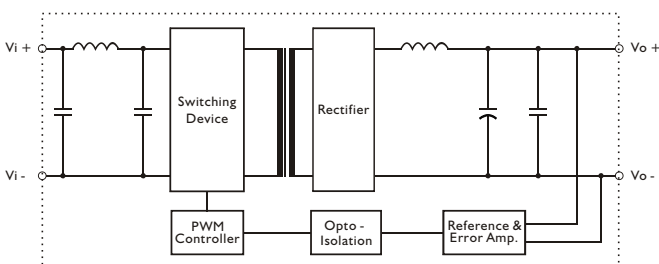

• Block diagram for IDD10U series with dual output

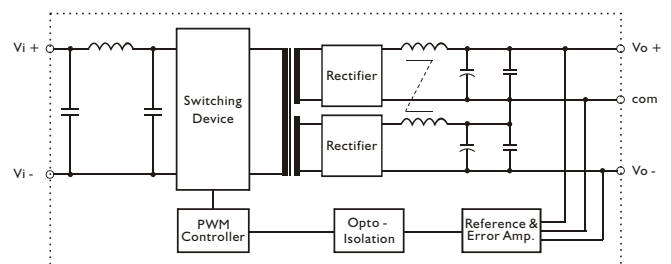

### RECOMMENDED CIRCUIT

- Recommended filter for EN55022 Class B compliance

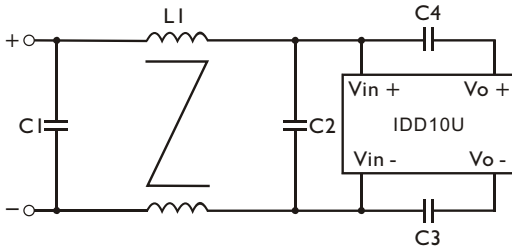

- The components used in the above figure, together with the manufacturer part numbers for these components, are as follows:

	C1	C2	C3	C4	L1
IDD10-XXX1U	3.3 $\mu$ F / 50V MLCC	2.2 $\mu$ F / 50V MLCC	1nF / 2KV MLCC	1nF / 2KV MLCC	500 $\mu$ H Common choke
IDD10-XXX2U	3.3 $\mu$ F / 50V MLCC	2.2 $\mu$ F / 50V MLCC	1nF / 2KV MLCC	1nF / 2KV MLCC	500 $\mu$ H Common choke
IDD10-XXX3U	3.3 $\mu$ F / 100V MLCC	2.2 $\mu$ F / 100V MLCC	1nF / 2KV MLCC	1nF / 2KV MLCC	500 $\mu$ H Common choke

- Recommended EN 55022 Class B filter circuit layout.

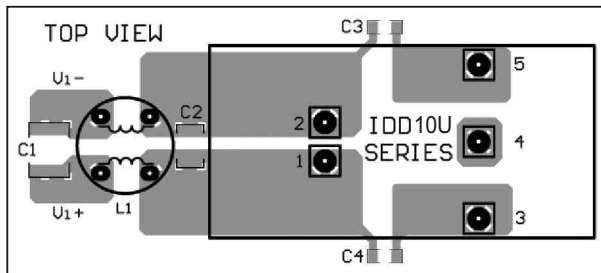

### DERATING AND EFFICIENCY CURVE

Temperature derating curve

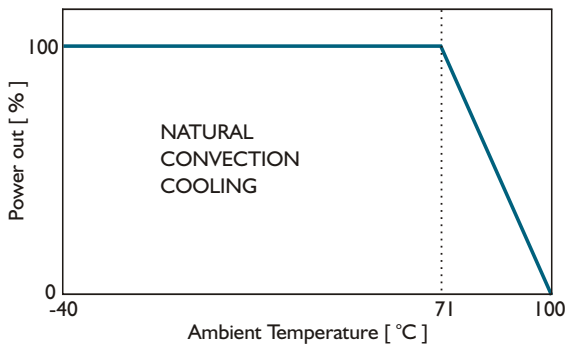

Efficiency Vs Input Voltage  
IDD10-05S2U

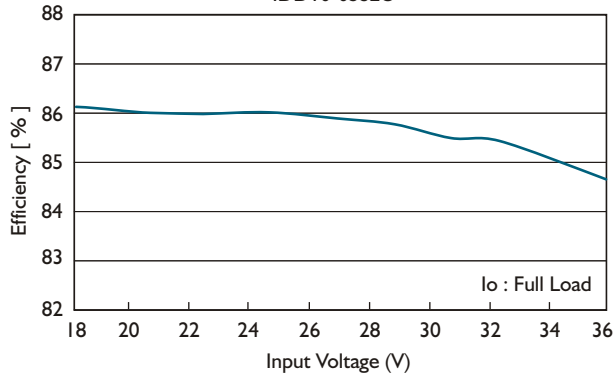

Efficiency Vs Output Load  
IDD10-05S2U

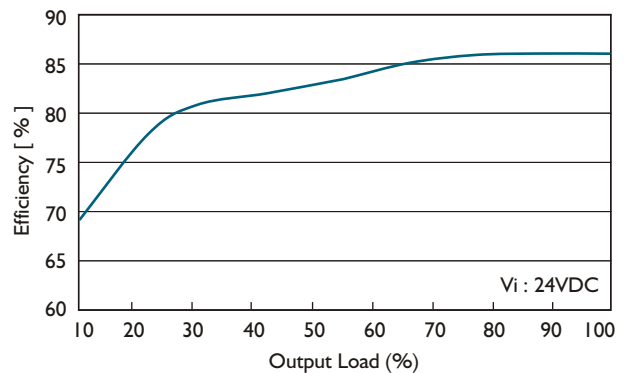

# IDD10U SERIES

DC - DC CONVERTER  
10W SINGLE & DUAL OUTPUT



## FEATURES

- EFFICIENCY UP TO 85%
- 4:1 WIDE INPUT RANGE
- I/O ISOLATION
- INPUT Pi FILTER
- SHORT CIRCUIT PROTECTION
- HIGH PERFORMANCE
- UL/cUL/TUV/CE
- 2 YEARS WARRANTY



EN 60950-1

## MODEL LIST

MODEL NO.	INPUT VOLTAGE	INPUT CURRENT (typ.)   (max.)		OUTPUT WATTAGE	OUTPUT VOLTAGE	OUTPUT CURRENT	EFF. (min.)	EFF. (typ.)	CAPACITOR LOAD (max.)
<b>Single Output Models</b>									
IDD10 - 03S4U	9~36 VDC	0.52 A	1.41 A	10 WATTS	+ 3.3 VDC	3000 mA	78%	80%	3500 $\mu$ F
IDD10 - 05S4U	9~36 VDC	0.52 A	1.37 A	10 WATTS	+ 5 VDC	2000 mA	80%	82%	3500 $\mu$ F
IDD10 - 12S4U	9~36 VDC	0.49 A	1.37 A	10 WATTS	+ 12 VDC	830 mA	82%	84%	1000 $\mu$ F
IDD10 - 15S4U	9~36 VDC	0.50 A	1.37 A	10 WATTS	+ 15 VDC	670 mA	83%	85%	1000 $\mu$ F
IDD10 - 03S5U	18~75 VDC	0.26 A	0.71 A	10 WATTS	+ 3.3 VDC	3000 mA	78%	80%	3500 $\mu$ F
IDD10 - 05S5U	18~75 VDC	0.26 A	0.70 A	10 WATTS	+ 5 VDC	2000 mA	80%	82%	3500 $\mu$ F
IDD10 - 12S5U	18~75 VDC	0.25 A	0.70 A	10 WATTS	+ 12 VDC	830 mA	82%	84%	1000 $\mu$ F
IDD10 - 15S5U	18~75 VDC	0.25 A	0.70 A	10 WATTS	+ 15 VDC	670 mA	82%	84%	1000 $\mu$ F
<b>Dual Output Models</b>									
IDD10 - 05D4U	9~36 VDC	0.51 A	1.40 A	10 WATTS	$\pm$ 5 VDC	$\pm$ 1000 mA	80%	82%	$\pm$ 3500 $\mu$ F
IDD10 - 12D4U	9~36 VDC	0.52 A	1.40 A	10 WATTS	$\pm$ 12 VDC	$\pm$ 420 mA	80%	82%	$\pm$ 1000 $\mu$ F
IDD10 - 15D4U	9~36 VDC	0.50 A	1.40 A	10 WATTS	$\pm$ 15 VDC	$\pm$ 340 mA	82%	84%	$\pm$ 1000 $\mu$ F
IDD10 - 05D5U	18~75 VDC	0.26 A	0.70 A	10 WATTS	$\pm$ 5 VDC	$\pm$ 1000 mA	80%	82%	$\pm$ 3500 $\mu$ F
IDD10 - 12D5U	18~75 VDC	0.25 A	0.70 A	10 WATTS	$\pm$ 12 VDC	$\pm$ 420 mA	81%	83%	$\pm$ 1000 $\mu$ F
IDD10 - 15D5U	18~75 VDC	0.25 A	0.70 A	10 WATTS	$\pm$ 15 VDC	$\pm$ 340 mA	82%	84%	$\pm$ 1000 $\mu$ F

### SPECIFICATION

All Specifications Typical At Nominal Line, Full Load, 25°C Unless Otherwise Noticed

GENERAL					
Characteristics	Conditions	min.	typ.	max.	unit
Switching frequency	Vi nom, Io nom		200		KHz
Isolation voltage	Input - Output	1500			VDC
Isolation resistance	Input - Output, @ 500VDC	100			MΩ
Isolation capacitance	100KHz / IV			1000	PF
Ambient temperature	Operating at Vi nom, Io nom	-40		+ 71	°C
Case temperature	Operating at Vi nom, Io nom			+100	°C
Derating	Vi nom	See derating curve			
Storage temperature	Non operational	-40		+100	°C
Relative humidity	Vi nom, Io nom	20		95	% RH
Temperature coefficient	Vi nom, Io min			± 0.02	% / °C
Dimension		L50.8 x W25.4 x H10.16			mm
MTBF	Bellcore issue 6@40°C, GB		1284000		Hours
Cooling	Free air convection				

INPUT SPECIFICATIONS					
Characteristics	Conditions	min.	typ.	max.	unit
Input voltage range	Ta min ... Ta max, Io nom	9	24	36	VDC
		18	48	75	VDC
No load input current	Vi nom, Io = 0	24V models		20	mA
		48V models		15	mA
Input voltage w/o damage	Io nom	24V models		40	VDC
		48V models		80	VDC
Startup voltage	Io nom	24V models	8.5		VDC
		48V models	16		VDC
Input filter	Pi type				

OUTPUT SPECIFICATIONS					
Characteristics	Conditions	min.	typ.	max.	unit
Output voltage accuracy	Vi nom, Io nom			± 2	%
Minimum load	Vi nom	0			%
	single output models				%
	dual output models (each output)	10			%
Line regulation	Io nom, Vi min ... Vi max			± 1	%
Load regulation	Vi nom, Io 0 ... Io nom, single output models			± 2	%
	Vi nom, Io min ... Io nom, dual output models			± 5	%
Cross regulationn (Dual model)	Asymmetrical load 10% - 100% FL			± 5	%
Startup time	Vi nom, Io nom			30	ms
Transient recovery time	Vi nom, I ~ 0.5 Io nom			500	μs
Ripple & noise *	Vi nom, Io nom, BW = 20MHz	3.3V & 5V models		100	mV
		12V, 15V & dual		150	mV
Efficiency	Vi nom, Io nom, Po / Pi	Up to 85%, See model list and efficiency curve			

\* Note : Output must be added 0.1 μF / 35V capacitor when application.

### SPECIFICATION

All Specifications Typical At Nominal Line, Full Load, 25°C Unless Otherwise Noticed

### CONTROL AND PROTECTION

Input reversed	Shunt diode built in, external fuse recommended (24Vin:2A, 48Vin:1A)
Output short circuit	Current limited (Auto-recovery)
Rated over load protection	110%min....160%max

### APPROVALS AND STANDARD

UL/cUL	UL 60950-1 Recognized
TUV	EN 60950-1, CB scheme
CE	EN 61204-3, EN 55022 Class A, EN 61000-4-2, EN61000-4-3, EN61000-4-4, EN61000-4-6
Vibration	meet IEC 60068-2-6 (10-500 Hz, 2G, along X, Y, Z each Axis, 60 min for each Axis)

### PHYSICAL CHARACTERISTICS

Case size	50.8 x 25.4 x 10.16 mm (2 x 1 x 0.4 inches)
Case material	Plastic base / Metal case
Weight	35 g
Patting material	Silicone

### MECHANISM & PIN CONFIGURATION

mm [inch]

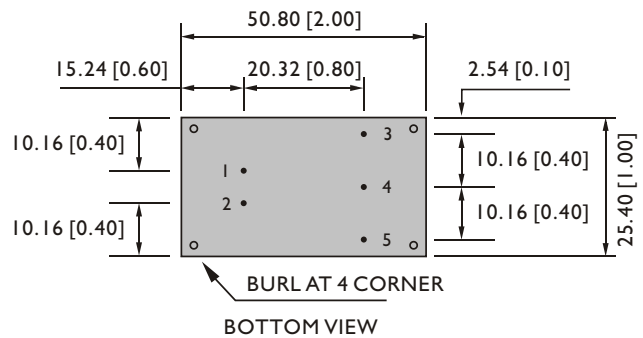
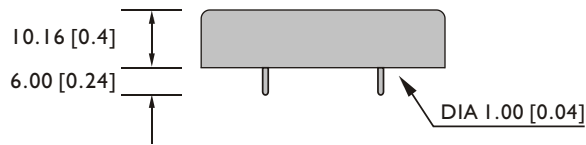

GENERAL TOLERANCE	
0.00[0.00] - 30.00[1.18]	±0.30[0.01]
30.00[1.18] - 120.00[4.72]	±0.50[0.02]

### PIN ASSIGNMENT

#### GENERAL

PIN NO.	1	2	3	4	5
SINGLE	Vi+	Vi-	Vo+	NO PIN	Vo-
DUAL	Vi+	Vi-	Vo+	com	Vo-

### CIRCUIT SCHEMATIC

• Block diagram for IDD10U series with single output

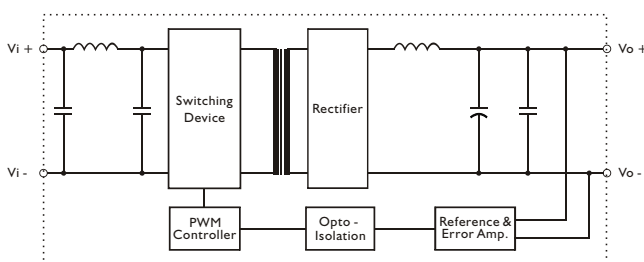

• Block diagram for IDD10U series with dual output

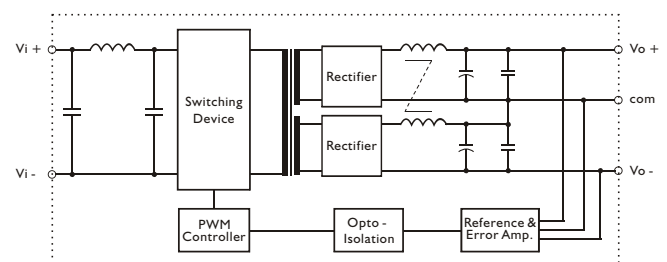

### RECOMMENDED CIRCUIT

- Recommended filter for EN55022 Class B compliance

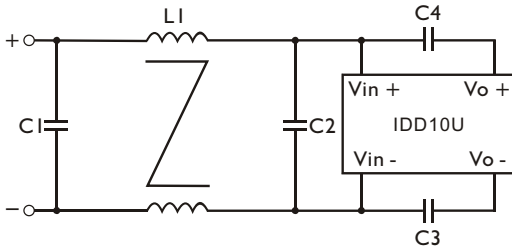

- The components used in the above figure, together with the manufacturer part numbers for these components, are as follows:

	C1	C2	C3	C4	L1
IDD10-XXX4U	3.3 $\mu$ F / 50V MLCC	2.2 $\mu$ F / 50V MLCC	1nF / 2KV MLCC	1nF / 2KV MLCC	500 $\mu$ H Common choke
IDD10-XXX5U	3.3 $\mu$ F / 100V MLCC	2.2 $\mu$ F / 100V MLCC	1nF / 2KV MLCC	1nF / 2KV MLCC	1 mH Common choke

- Recommended EN 55022 Class B filter circuit layout.

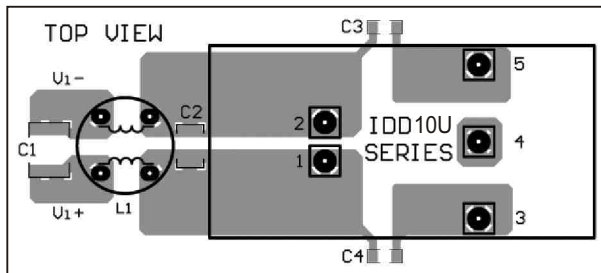

### DERATING AND EFFICIENCY CURVE

Temperature derating curve

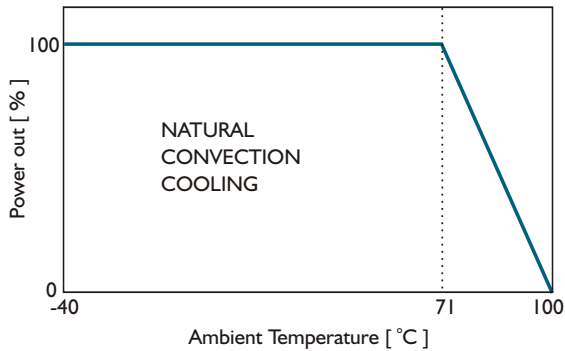

Efficiency Vs Input Voltage  
IDD10-05S4U

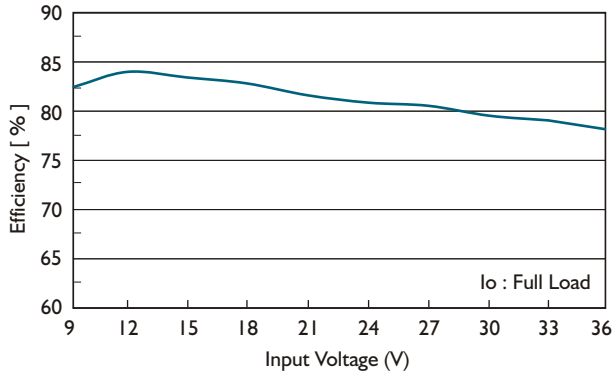

Efficiency Vs Output Load  
IDD10-05S4U

