



### FEATURES

- ◆ Ultra-wide 2:1 input range
- ◆ DIP-16 package
- ◆ Efficiency up to 81%
- ◆ Temperature range -40°C to +85°C
- ◆ HMTBF > 1,000,000 Hours
- ◆ Low Ripple and Noise
- ◆ Short Circuit Protection
- ◆ I/O isolation 1500 VDC
- ◆ Complies with EN55022 Class A
- ◆ Fully RoHS compliant
- ◆ UL 94 V-0 Package Material
- ◆ Internal SMD Construction

### MODEL SELECTION

**WRA<sup>①</sup> 24<sup>②</sup> 05<sup>③</sup> Y<sup>④</sup> GD<sup>⑤</sup>-2W(119)<sup>⑥</sup>**

- ① Product Series
- ② Input Voltage
- ③ Output Voltage
- ④ Wide (2:1) Input Range
- ⑤ DIP16 Package Style
- ⑥ Rated Power(Output current)

### DESCRIPTION

The WRA-YGD-2W & WRB-YGD-2W Series power modules are low-profile dc-dc converters that operate over input voltage of 4.5-9VDC, 9-18VDC, 18-36VDC and 36-75VDC which provide precisely regulated output voltages of 3.3V, 5V, 12V, 15V, ±5V, ±12V and ±15VDC.

The WRA-YGD-2W & WRB-YGD-2W Series is an excellent for data communication equipments, mobile battery driven equipments, distributed power systems, telecommunication equipments, mixed analog/machine control equipments, computer peripheral systems and industrial robot systems.

The modules have a maximum power rating of 2W and a typical full-load efficiency of 81%, continuous short circuit, 30mV output ripple, built-in filtering for both input and output minimize the need for external filtering.



### Absolute Maximum Ratings

| Parameter                                     | Min.               | Max.  | Unit. |     |
|---|--------------------|-------|-------|-----|
| Input Sure Voltage<br>(1000 mS)               | 5VDC Input Models  | -0.7  | 11    | VDC |
|   | 12VDC Input Models | -0.7  | 25    | VDC |
|   | 24VDC Input Models | -0.7  | 50    | VDC |
|   | 48VDC Input Models | -0.7  | 100   | VDC |
| Lead Temperature(1.5mm from case for 10 Sec.) | ---                | 260   | °C    |     |
| Internal Power Dissipation                    | ---                | 1,800 | mW    |     |

### Environmental Specifications

| Parameter             | Conditions          | Min. | Max. | Unit. |
|-----------------------|---------------------|------|------|-------|
| Operating Temperature | Ambient             | -40  | +65  | °C    |
| Operating Temperature | Case                | -40  | +90  | °C    |
| Storage Temperature   |                     | -40  | +125 | °C    |
| Humidity              |                     | ---  | 95   | %     |
| Cooling               | Free-Air Convection |      |      |       |
| Conducted             | EN55022 Class A     |      |      |       |

Exceeding the absolute maximum ratings of the unit could cause damage.  
These are not continuous operating ratings.

### Capacitive Load

| Models by Vout          | 3.3V | 5V   | 12V | 15V | ±5V * | ±12V * | ±15V* | Unit |
|-------------------------|------|------|-----|-----|-------|--------|-------|------|
| Maximum Capacitive Load | 2200 | 1000 | 110 | 470 | 100   | 20     | 47    | uF   |

\* For each output

### Input Fuse Selection Guide

| 5V Input Models         | 12V Input Models       | 24V Input Models       | 48V Input Models       |
|-------------------------|------------------------|------------------------|------------------------|
| 1000mA Slow - Blow Type | 500mA Slow - Blow Type | 250mA Slow - Blow Type | 120mA Slow - Blow Type |

### SELECTION GUIDE

| Model Number   | Input Voltage   | Output Voltage | Output Current |           | Input Current           |                       | Reflected Ripple Current<br>% (Max.) | Efficiency             |
|----------------|-----------------|----------------|----------------|-----------|-------------------------|-----------------------|--------------------------------------|------------------------|
|                | VDC             | VDC            | Max<br>mA      | Min<br>mA | @Max. Load<br>mA (Typ.) | @No Load<br>mA (Typ.) |                                      | @Max. Load<br>% (Typ.) |
| WRB0503YGD-500 | 5<br>(4.5 ~ 9)  | 3.3            | 500            | 125       | 471                     | 40                    | 100                                  | 70                     |
| WRB0505YGD-2W  |                 | 5              | 400            | 100       | 548                     | 40                    | 100                                  | 73                     |
| WRB0512YGD-2W  |                 | 12             | 167            | 42        | 534                     | 40                    | 100                                  | 75                     |
| WRB0515YGD-2W  |                 | 15             | 134            | 33        | 582                     | 40                    | 100                                  | 73                     |
| WRA0505YGD-2W  |                 | ±5             | ±200           | ±50       | 667                     | 40                    | 100                                  | 64                     |
| WRA0512YGD-2W  |                 | ±12            | ±83            | ±21       | 615                     | 40                    | 100                                  | 69                     |
| WRA0515YGD-2W  |                 | ±15            | ±67            | ±17       | 598                     | 40                    | 100                                  | 71                     |
| WRB1203YGD-500 | 12<br>(9 ~ 18)  | 3.3            | 500            | 125       | 184                     | 20                    | 25                                   | 73                     |
| WRB1205YGD-2W  |                 | 5              | 400            | 100       | 217                     | 20                    | 25                                   | 77                     |
| WRB1212YGD-2W  |                 | 12             | 167            | 42        | 209                     | 20                    | 25                                   | 80                     |
| WRB1215YGD-2W  |                 | 15             | 134            | 33        | 220                     | 20                    | 25                                   | 80                     |
| WRA1205YGD-2W  |                 | ±5             | ±200           | ±50       | 242                     | 20                    | 25                                   | 73                     |
| WRA1212YGD-2W  |                 | ±12            | ±83            | ±21       | 224                     | 20                    | 25                                   | 78                     |
| WRA1215YGD-2W  |                 | ±15            | ±67            | ±17       | 226                     | 20                    | 25                                   | 78                     |
| WRB2403YGD-500 | 24<br>(18 ~ 36) | 3.3            | 500            | 125       | 96                      | 10                    | 15                                   | 72                     |
| WRB2405YGD-2W  |                 | 5              | 400            | 100       | 109                     | 10                    | 15                                   | 77                     |
| WRB2412YGD-2W  |                 | 12             | 167            | 42        | 109                     | 10                    | 15                                   | 80                     |
| WRB2415YGD-2W  |                 | 15             | 134            | 33        | 108                     | 10                    | 15                                   | 81                     |
| WRA2405YGD-2W  |                 | ±5             | ±200           | ±50       | 119                     | 10                    | 15                                   | 74                     |
| WRA2412YGD-2W  |                 | ±12            | ±83            | ±21       | 112                     | 10                    | 15                                   | 78                     |
| WRA2415YGD-2W  |                 | ±15            | ±67            | ±17       | 110                     | 10                    | 15                                   | 80                     |
| WRB4803YGD-500 | 48<br>(36 ~ 75) | 3.3            | 500            | 125       | 49                      | 8                     | 10                                   | 71                     |
| WRB4805YGD-2W  |                 | 5              | 400            | 100       | 57                      | 8                     | 10                                   | 73                     |
| WRB4812YGD-2W  |                 | 12             | 167            | 42        | 53                      | 8                     | 10                                   | 79                     |
| WRB4815YGD-2W  |                 | 15             | 134            | 33        | 55                      | 8                     | 10                                   | 79                     |
| WRA4805YGD-2W  |                 | ±5             | ±200           | ±50       | 62                      | 8                     | 10                                   | 71                     |
| WRA4812YGD-2W  |                 | ±12            | ±83            | ±21       | 57                      | 8                     | 10                                   | 77                     |
| WRA4815YGD-2W  |                 | ±15            | ±67            | ±17       | 57                      | 8                     | 10                                   | 77                     |

### Input Specifications

| Parameter                      | Mode             | Min.      | Typ. | Max. | Unit. |
|--------------------------------|------------------|-----------|------|------|-------|
| Start Voltage                  | 5V Input Models  | 3.5       | 4    | 4.5  | VDC   |
|                                | 12V Input Models | 4.5       | 7    | 9    | VDC   |
|                                | 24V Input Models | 8         | 12   | 18   | VDC   |
|                                | 48V Input Models | 16        | 24   | 36   | VDC   |
| Under Voltage Shutdown         | 5V Input Models  | ---       | 3.5  | 4    | VDC   |
|                                | 12V Input Models | ---       | 6.5  | 8.5  | VDC   |
|                                | 24V Input Models | ---       | 11   | 17   | VDC   |
|                                | 48V Input Models | ---       | 22   | 34   | VDC   |
| Reverse Polarity Input Current | All Models       | ---       | ---  | 1    | A     |
| Short Circuit Input Power      | All Models       | ---       | ---  | 1500 | mW    |
| Input Filter                   | All Models       | Pi Filter |      |      |       |

### Output Specifications

| Parameter                    | Conditions                  | Min. | Typ.  | Max.  | Unit.  |
|------------------------------|-----------------------------|------|-------|-------|--------|
| Output Voltage Accuracy      |                             | ---  | ±1.0  | ±2.0  | %      |
| Output Voltage Balance       | Dual Output, Balanced Loads | ---  | ±1.0  | ±2.0  | %      |
| Line Regulation              | Vin=Min. to Max             | ---  | ±0.3  | ±0.5  | %      |
| Load Regulation              | Io=25% to 100%              | ---  | ±0.5  | ±0.75 | %      |
| Ripple & Noise (20MHz)       |                             | ---  | 30    | 50    | mV P-P |
| Ripple & Noise (20MHz)       | Over Line, Load & Temp      | ---  | ---   | 75    | mV P-P |
| Ripple & Noise (20MHz)       |                             | ---  | ---   | 15    | mV rms |
| Over Power Protection        |                             | 120  | ---   | ---   | %      |
| Transient Recovery Time      | 25% Load Step Change        | ---  | 100   | 300   | uS     |
| Transient Response Deviation | 25% Load Step Change        | ---  | ±3    | ±5    | %      |
| Temperature Coefficient      |                             | ---  | ±0.01 | ±0.02 | %/]    |
| Output Short Circuit         | Continuous                  |      |       |       |        |

| General Specifications  |                                     |      |      |      |         |
|-------------------------|-------------------------------------|------|------|------|---------|
| Parameter               | Conditions                          | Min. | Typ. | Max. | Unit.   |
| Isolation Voltage Rated | 60 Seconds                          | 1500 | ---  | ---  | VDC     |
| Isolation Voltage Test  | Flash Tested for 1 Second           | 1650 | ---  | ---  | VDC     |
| Isolation Resistance    | 500VDC                              | 1000 | ---  | ---  | MΩ      |
| Isolation Capacitance   | 100KHz,1V                           | ---  | 250  | 420  | pF      |
| Switching Frequency     |                                     | ---  | 300  | ---  | KHz     |
| MTBF                    | MIL-HDBK-217F @ 25°C, Ground Benign | 1000 | ---  | ---  | K Hours |

Notes :

- Specifications typical at Ta=+25°C, resistive load, nominal input voltage, rated output current unless otherwise noted.
- Transient recovery time is measured to within 1%error band for a step change in output load of 75% to 100%.
- Ripple & Noise measurement bandwidth is 0-20 MHz.
- These power converters require a minimum output loading to maintain specified regulation.
- Operation under no-load conditions will not damage these modules; however, they may not meet all specifications listed.
- All DC/DC converters should be externally fused on the front end for protection.
- Other input and output voltage may be available, please contact factory.
- Specifications subject to change without notice

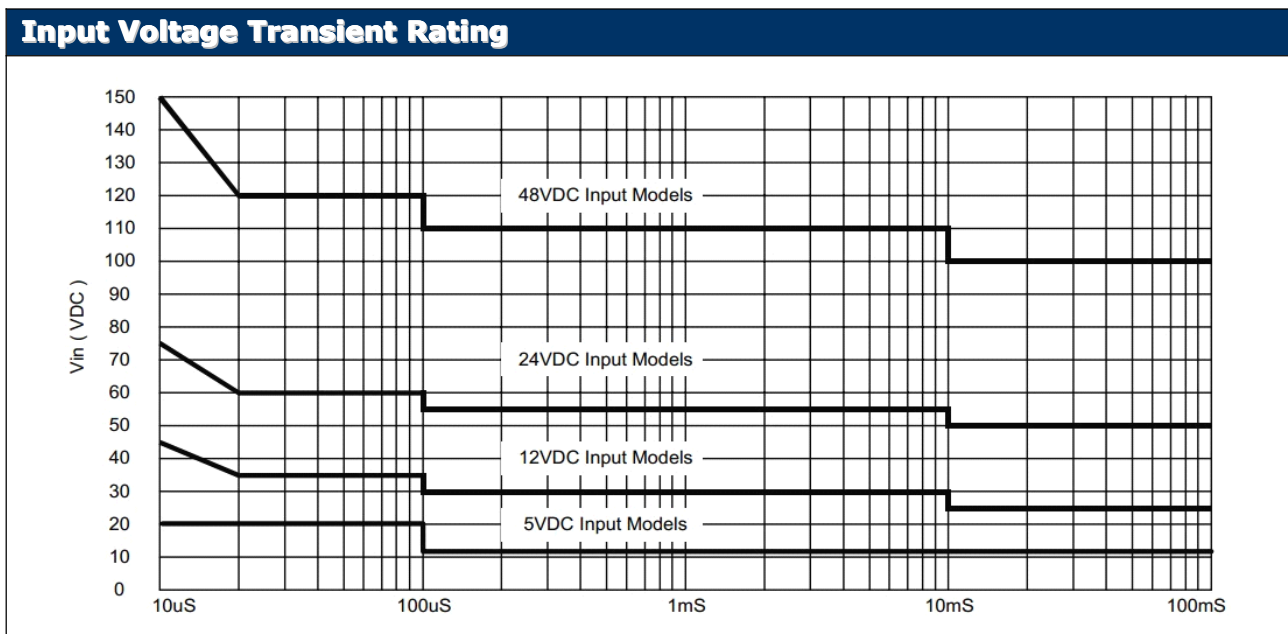
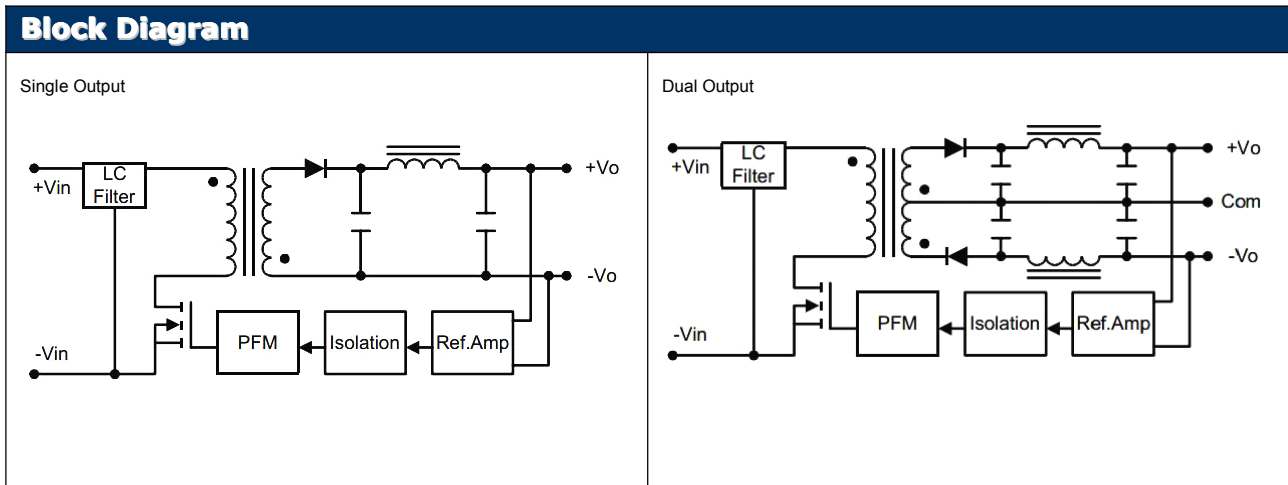

### Input Voltage Transient Rating

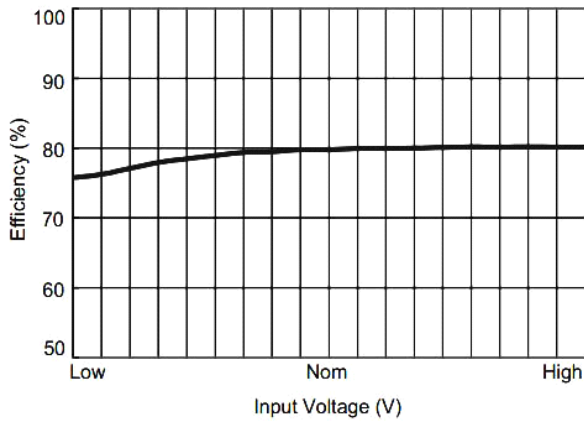

Efficiency vs Input Voltage ( Single Output )

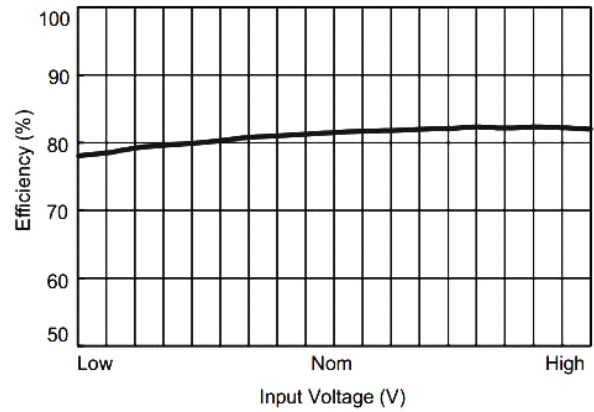

Efficiency vs Input Voltage ( Dual Output )

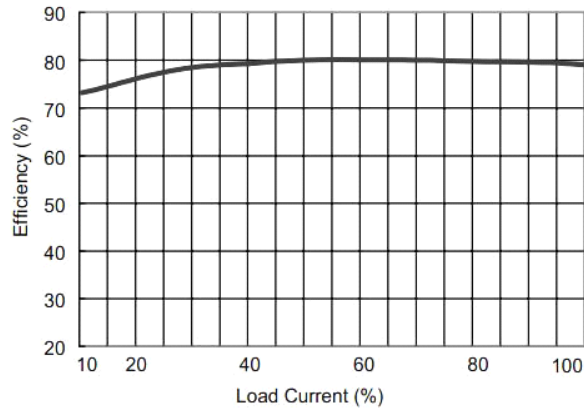

Efficiency vs Output Load ( Single Output )

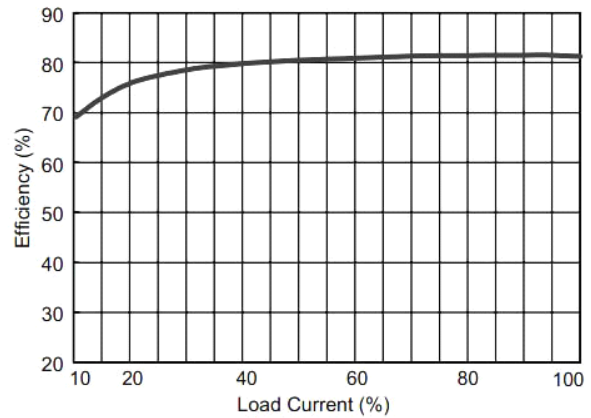

Efficiency vs Output Load ( Dual Output )

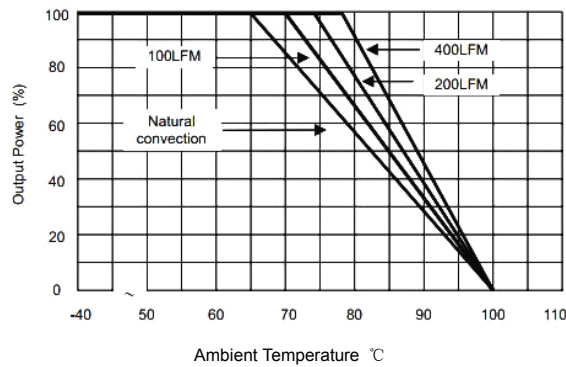

Derating Curve

### Test Configurations

#### Input Reflected-Ripple Current Test Setup

Input reflected-ripple current is measured with an inductor  $L_{in}$  (4.7uH) and  $C_{in}$  (220uF, ESR < 1.0[ at 100 kHz) to simulated source impedance.

Capacitor  $C_{in}$ , offsets possible battery impedance.

Current ripple is measured at the input terminals of the module, measurement bandwidth is 0-500KHz.

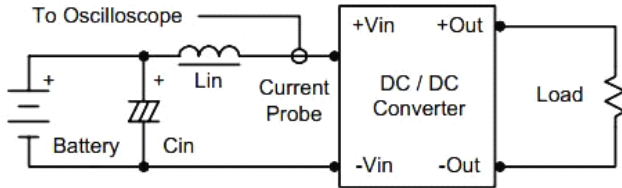

#### Peak-to-Peak Output Noise Measurement Test

Use a  $C_{out}$  0.47uF ceramic capacitor.

Scope measurement should be made by using a BNC socket, measurement bandwidth is 0-20 MHz. Position the load between 50 mm and 75 mm from the DC/DC Converter.

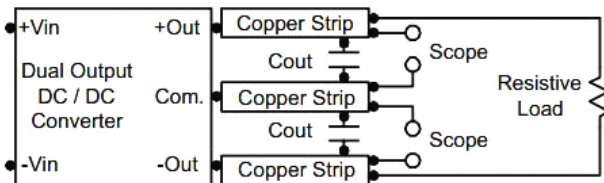
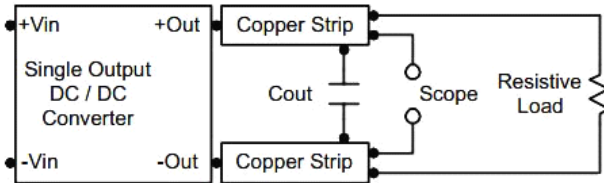

### Design & Feature Considerations

#### Maximum Capacitive Load

The WRA(B)-YGD-2W series has limitation of maximum connected capacitance on the output.

The power module may operate in current limiting mode during start-up, affecting the ramp-up and the startup time.

The maximum capacitance can be found in the data sheet.

To provide protection in a fault (output overload) condition, the unit is equipped with internal current limiting circuitry and can endure current limiting for an unlimited duration. At the point of current-limit inception, the unit shifts from voltage control to current control. The unit operates normally once the output current is brought back into its specified range.

#### Input Source Impedance

The power module should be connected to a low ac-impedance input source. Highly inductive source impedances can affect the stability of the power module.

In applications where power is supplied over long lines and output loading is high, it may be necessary to use a capacitor on the input to insure startup.

By using a good quality low Equivalent Series Resistance (ESR < 1.0[ at 100 kHz) capacitor of a 8.2uF for the 5V input devices, a 3.3uF for the 12V input devices and a 1.5uF for the 24V and 48V devices, capacitor mounted close to the power module helps ensure stability of the unit.

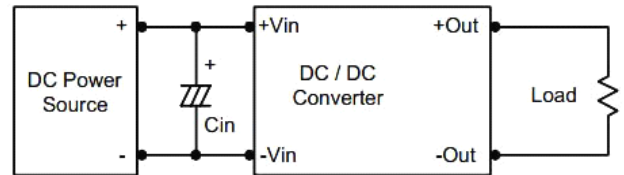

#### Output Ripple Reduction

A good quality low ESR capacitor placed as close as practicable across the load will give the best ripple and noise performance.

To reduce output ripple, it is recommended that 3.3uF capacitors are used on output.

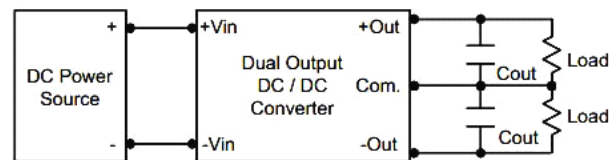
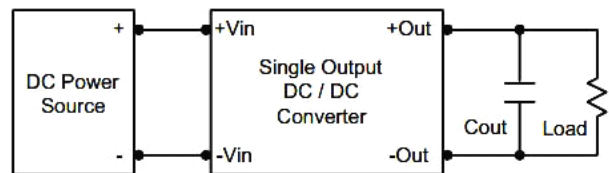

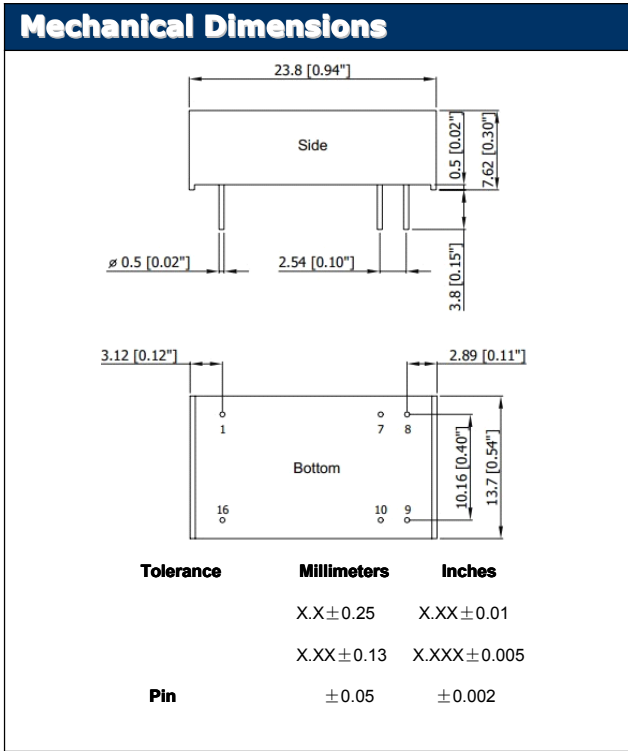

### Physical Characteristics

|                |  |
|----------------|--|
| Case Size :    | 23.8*13.7*7.62 mm<br>0.94*0.54*0.30 inches |
| Case Material: | Non-Conductive Black Plastic               |
| Weight:        | 5.1g                                       |
| Flammability:  | UL94V-0                                    |

### Pin Connections

| Pin | Single Output | Dual Output |
|-----|---------------|-------------|
| 1   | -Vin          | -Vin        |
| 7   | NC            | NC          |
| 8   | NC            | Common      |
| 9   | +Vout         | +Vout       |
| 10  | -Vout         | -Vout       |
| 16  | +Vin          | +Vin        |

NC: No Connection

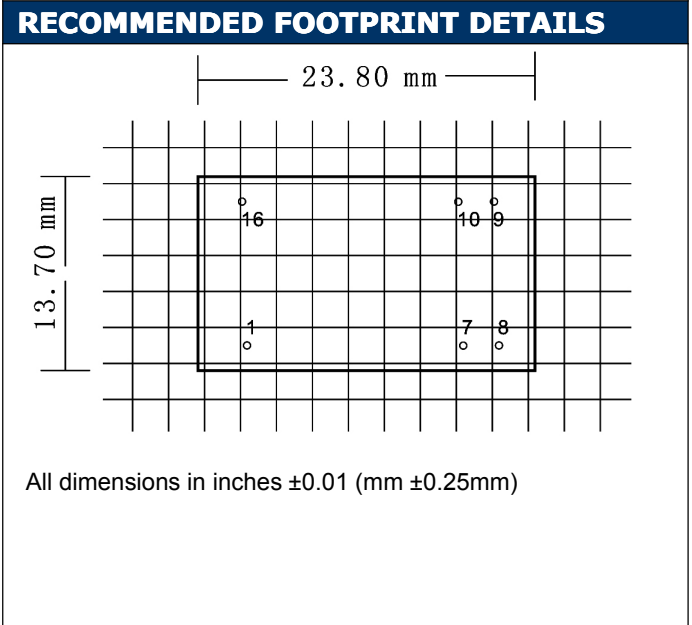

#### RoHS COMPLIANT INFORMATION

This series is compatible with RoHS soldering systems with a peak wave solder temperature of 300° C for 10 seconds.  
 The pin termination finish on the SIP package type is Tin Plate, Hot Dipped over Matte Tin with Nickel Preplate. The DIP types are Matte Tin over Nickel Preplate. Both types in this series are backward compatible with Sn/Pb soldering systems.

#### REACH COMPLIANT INFORMATION

This series has proven that this product does not contain harmful chemicals, it also has harmful chemical substances through the registration, inspection and approval.