



SANYO Semiconductors

# DATA SHEET

An ON Semiconductor Company

Monolithic Digital IC

## LB1836M — Low-Saturation Bidirectional Motor Driver for Low-Voltage Drive

### Overview

The LB1836M is a low-saturation two-channel bidirectional motor driver IC for use in low-voltage applications.

The LB1836M is a bipolar stepper-motor driver IC that is ideal for use in printers, FDDs, cameras and other portable devices.

### Features

- Low voltage operation (2.5V min)
- Low saturation voltage (upper transistor + lower transistor residual voltage ; 0.40V typ at 400mA).
- Parallel connection (Upper transistor + lower transistor residual voltage ; 0.5V typ at 800mA).
- Separate logic power supply and motor power supply
- Brake function
- Spark killer diodes built in
- Thermal shutdown circuit built in
- Compact package (14-pin MFP)

### Specifications

**Absolute Maximum Ratings** at  $T_a = 25^\circ\text{C}$

Parameter	Symbol	Conditions	Ratings	Unit
Maximum supply voltage	$V_{CC\ max}$		-0.3 to +10.5	V
	$V_S\ max$		-0.3 to +10.5	V
Output supply voltage	$V_{OUT}$		$V_S + V_{SF}$	V
Input supply voltage	$V_{IN}$		-0.3 to +10	V
GND pin flow-out current	IGND	Per channel	1.0	A
Allowable power dissipation	$P_d\ max$	* Mounted on a board.	800	mW
Operating temperature	$T_{opr}$		-40 to +85	$^\circ\text{C}$
Storage temperature	$T_{stg}$		-55 to +150	$^\circ\text{C}$

\* Mounted on a substrate:  $30 \times 30 \times 1.5\text{mm}^3$ , glass epoxy board.

■ Any and all SANYO Semiconductor Co.,Ltd. products described or contained herein are, with regard to "standard application", intended for the use as general electronics equipment (home appliances, AV equipment, communication device, office equipment, industrial equipment etc.). The products mentioned herein shall not be intended for use for any "special application" (medical equipment whose purpose is to sustain life, aerospace instrument, nuclear control device, burning appliances, transportation machine, traffic signal system, safety equipment etc.) that shall require extremely high level of reliability and can directly threaten human lives in case of failure or malfunction of the product or may cause harm to human bodies, nor shall they grant any guarantee thereof. If you should intend to use our products for applications outside the standard applications of our customer who is considering such use and/or outside the scope of our intended standard applications, please consult with us prior to the intended use. If there is no consultation or inquiry before the intended use, our customer shall be solely responsible for the use.

■ Specifications of any and all SANYO Semiconductor Co.,Ltd. products described or contained herein stipulate the performance, characteristics, and functions of the described products in the independent state, and are not guarantees of the performance, characteristics, and functions of the described products as mounted in the customer's products or equipment. To verify symptoms and states that cannot be evaluated in an independent device, the customer should always evaluate and test devices mounted in the customer's products or equipment.

**SANYO Semiconductor Co., Ltd.**

[www.semiconductor-sanyo.com/network](http://www.semiconductor-sanyo.com/network)

# LB1836M

## Allowable Operating Ranges at $T_a = 25^\circ\text{C}$

Parameter	Symbol	Conditions	Ratings	Unit
Supply voltage	$V_{CC}$		2.5 to 9.0	V
	$V_S$		1.8 to 9.0	V
Input "H"-level voltage	$V_{IH}$		1.8 to 9.0	V
Input "L"-level voltage	$V_{IL}$		-0.3 to +0.7	V

## Electrical Characteristics at $T_a = 25^\circ\text{C}$ , $V_{CC} = V_S = 3\text{V}$

Parameter	Symbol	Conditions	Ratings			Unit
			min	typ	max	
Supply current	$I_{CC0}$	$V_{IN1, 2, 3, 4} = 0\text{V}$ , $I_{CC} + I_S$		0.1	10	$\mu\text{A}$
	$I_{CC1}$	$V_{IN1} = 3\text{V}$ , $V_{IN2, 3, 4} = 0\text{V}$ , $I_{CC} + I_S$		14	20	mA
	$I_{CC2}$	$V_{IN1, 2} = 3\text{V}$ , $V_{IN3, 4} = 0\text{V}$ , $I_{CC} + I_S$		22	35	mA
Output saturation voltage (upper + lower)	$V_{OUT1}$	$I_{OUT} = 200\text{mA}$		0.20	0.28	V
	$V_{OUT2}$	$I_{OUT} = 400\text{mA}$		0.40	0.60	V
	$V_{OUT3}$	$I_{OUT} = 400\text{mA}$ , Parallel connection		0.25	0.35	V
	$V_{OUT4}$	$I_{OUT} = 800\text{mA}$ , Parallel connection		0.50	0.70	V
Output sustain voltage	$V_O$ (SUS)	$I_{OUT} = 400\text{mA}$	9			V
Input current	$I_{IN}$	$V_{IN} = 2\text{V}$ , $V_{CC} = 6\text{V}$			80	$\mu\text{A}$
<b>Spark killer diode</b>						
Reverse current	$I_S$ (leak)	$V_{CC1, 2} = 9\text{V}$			30	$\mu\text{A}$
Forward voltage	$V_{SF}$	$I_{OUT} = 400\text{mA}$			1.7	V

## Package Dimensions

unit : mm (typ)

3111A

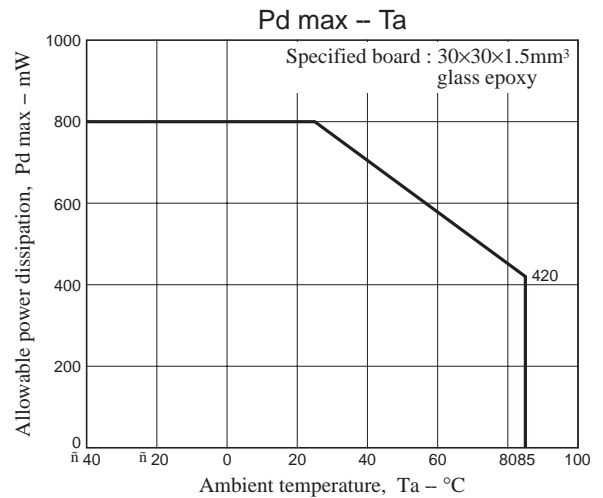
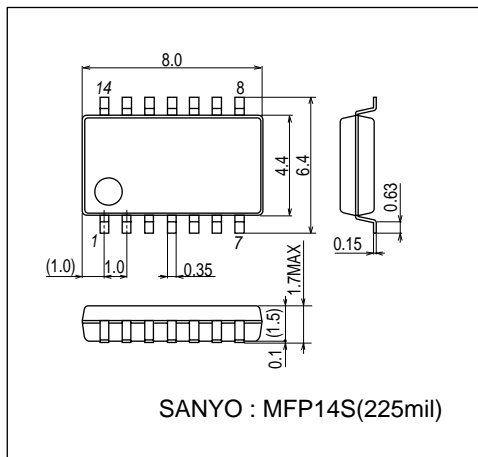

## Pin Assignment

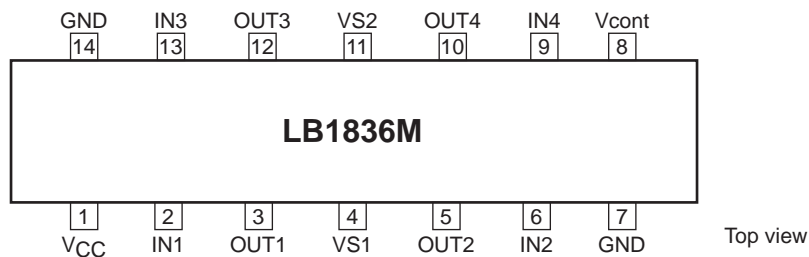

Note) Ground both GND pins.

# LB1836M

## Block Diagram

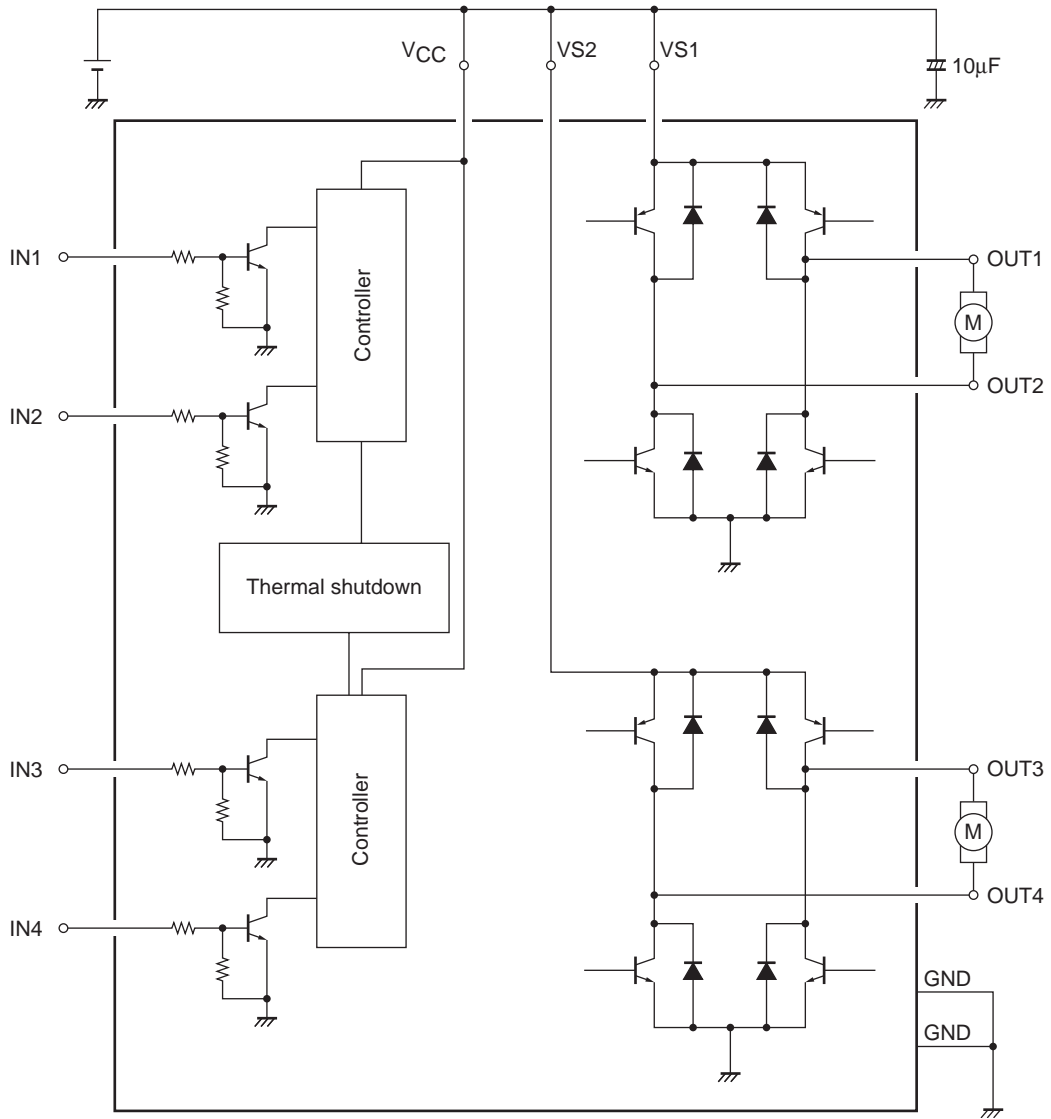

## Truth Table

IN1/3	IN2/4	OUT1/3	OUT2/4	Mode
H	L	H	L	Forward
L	H	L	H	Reverse
H	H	L	L	Brake
L	L	OFF	OFF	Standby

## Design Notes

If large current flows on the power supply ( $V_S$ ) line and the GND line, then in some applications and layouts, misoperation due to line oscillation may result.

The modes during which large current flows are as follows :

- Motor surge current when the DC motor starts up or when it shifts rotation directions (forward  $\leftrightarrow$  reverse).
- Passthrough current generated within the IC when shifting rotation directions (forward  $\leftrightarrow$  reverse) or when shifting from forward/reverse rotation to braking, or vice versa.

The following points should be kept in mind regarding the pattern layout :

- Keep the wiring lines thick and short in order to reduce wiring inductance between the power supply ( $V_S$ ) and GND.
- Insert a passthrough capacitor near the IC. (Maximum effect is obtained by inserting the passthrough capacitor between  $V_S$  and the pin 7 GND at the closest distance possible).
- If the CPU and the LB1836M are mounted on separate boards and the difference between the ground potential of each board is large, install resistors of about  $10k\Omega$  in series between the CPU and the LB1836M inputs.

## Vcont pin

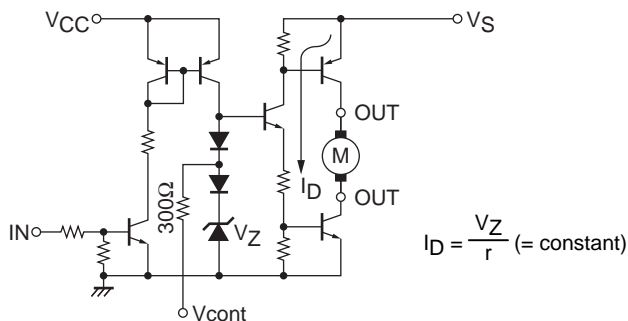

As shown in the above diagram, the Vcont pin outputs the voltage of the band gap Zener  $V_Z + V_F (=1.93V)$ .

In normal use, this pin is left open.

The drive current  $I_D$  is varied by the Vcont voltage. However, because the band gap Zener is shared, it functions as a bridge.

# LB1836M

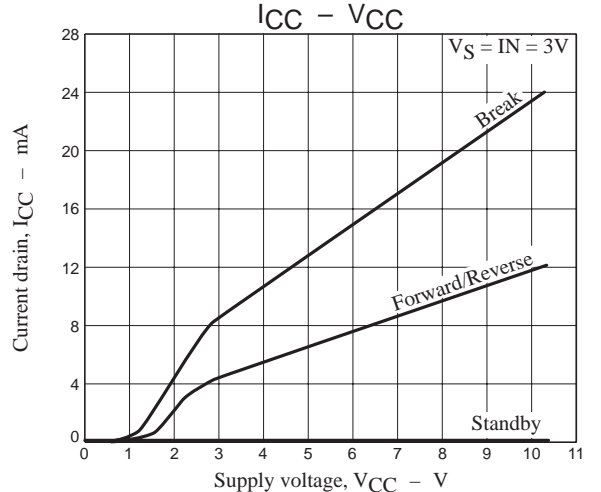
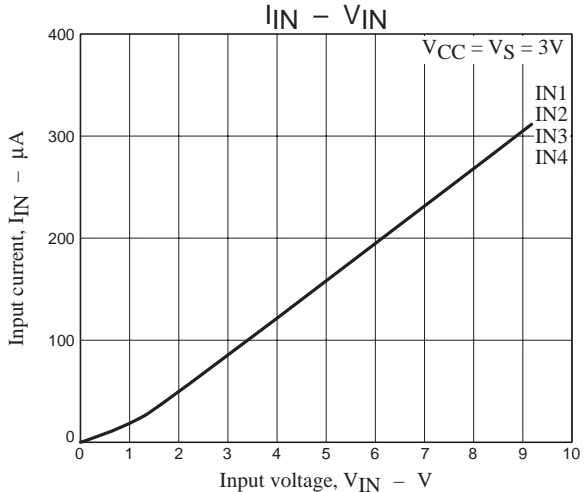
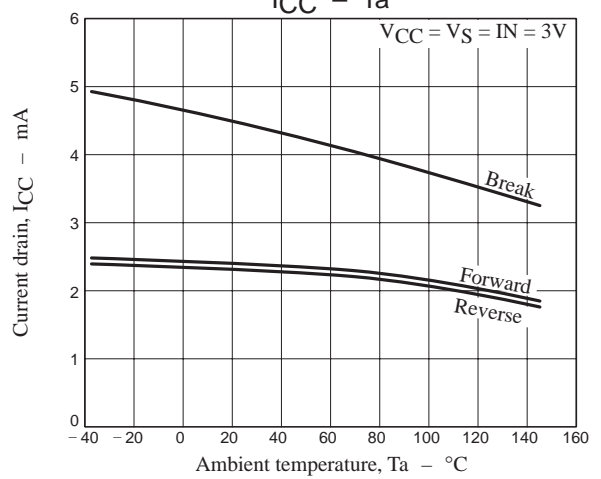
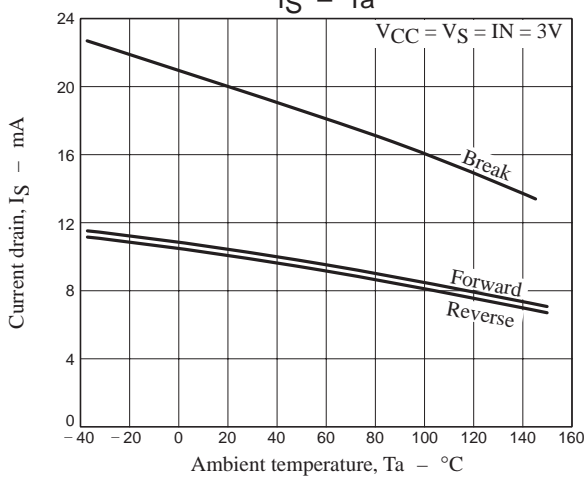
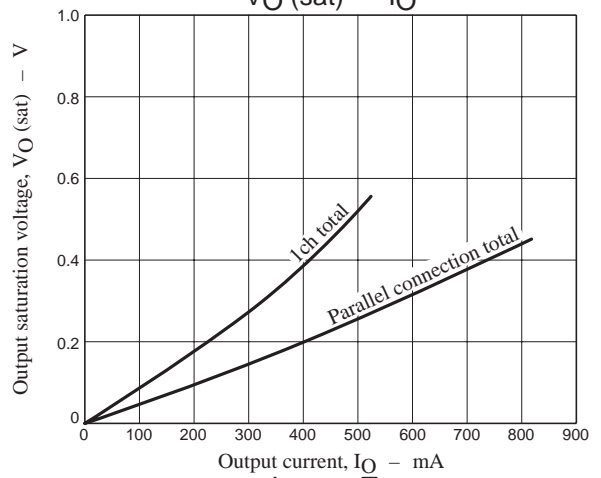
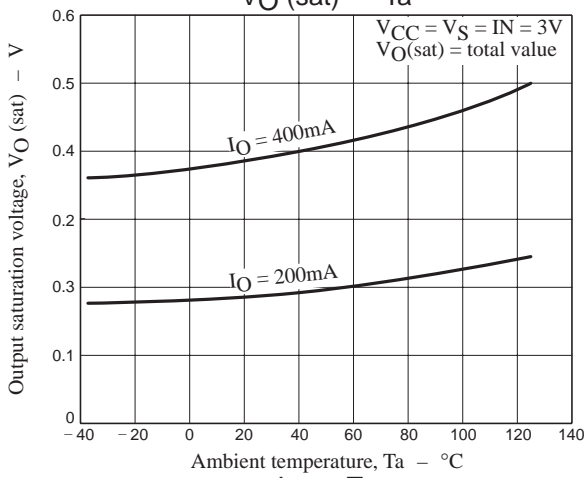
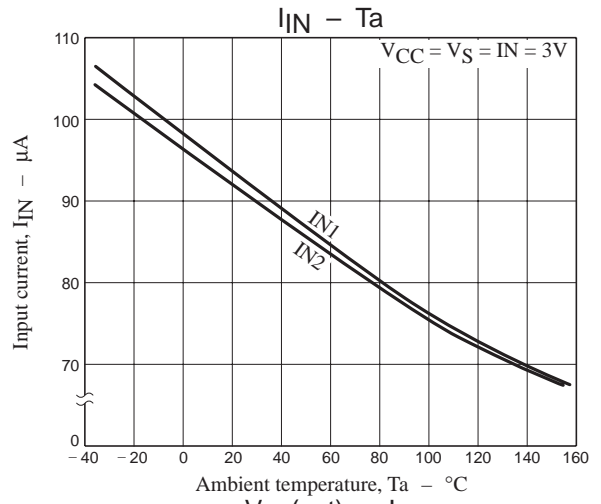
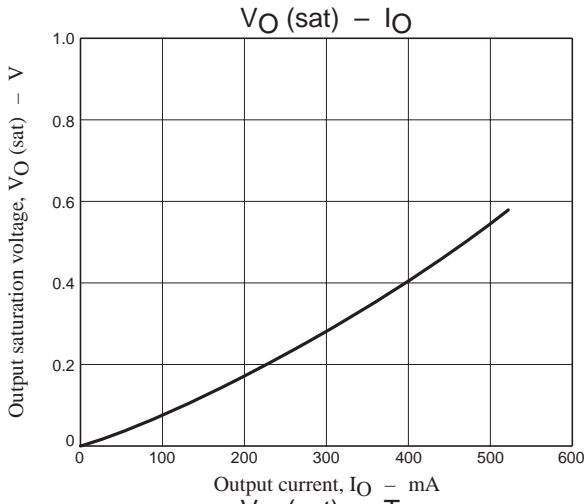

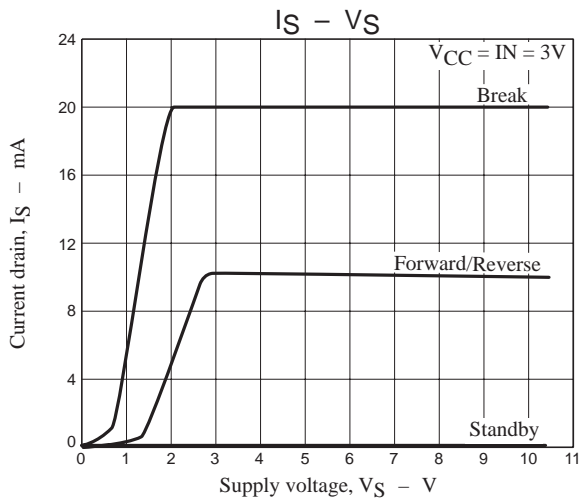

■ SANYO Semiconductor Co.,Ltd. assumes no responsibility for equipment failures that result from using products at values that exceed, even momentarily, rated values (such as maximum ratings, operating condition ranges, or other parameters) listed in products specifications of any and all SANYO Semiconductor Co.,Ltd. products described or contained herein.

■ SANYO Semiconductor Co.,Ltd. strives to supply high-quality high-reliability products, however, any and all semiconductor products fail or malfunction with some probability. It is possible that these probabilistic failures or malfunction could give rise to accidents or events that could endanger human lives, trouble that could give rise to smoke or fire, or accidents that could cause damage to other property. When designing equipment, adopt safety measures so that these kinds of accidents or events cannot occur. Such measures include but are not limited to protective circuits and error prevention circuits for safe design, redundant design, and structural design.

■ In the event that any or all SANYO Semiconductor Co.,Ltd. products described or contained herein are controlled under any of applicable local export control laws and regulations, such products may require the export license from the authorities concerned in accordance with the above law.

■ No part of this publication may be reproduced or transmitted in any form or by any means, electronic or mechanical, including photocopying and recording, or any information storage or retrieval system, or otherwise, without the prior written consent of SANYO Semiconductor Co.,Ltd.

■ Any and all information described or contained herein are subject to change without notice due to product/technology improvement, etc. When designing equipment, refer to the "Delivery Specification" for the SANYO Semiconductor Co.,Ltd. product that you intend to use.

■ Information (including circuit diagrams and circuit parameters) herein is for example only; it is not guaranteed for volume production.

■ Upon using the technical information or products described herein, neither warranty nor license shall be granted with regard to intellectual property rights or any other rights of SANYO Semiconductor Co.,Ltd. or any third party. SANYO Semiconductor Co.,Ltd. shall not be liable for any claim or suits with regard to a third party's intellectual property rights which has resulted from the use of the technical information and products mentioned above.

This catalog provides information as of March, 2010. Specifications and information herein are subject to change without notice.