

# GBU25A-GBU25M

Silicon Bridge Rectifiers

**VOLTAGE RANGE: 50 --- 1000 V**

**CURRENT: 25.0 A**

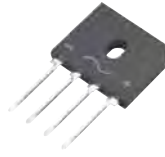

## GBU

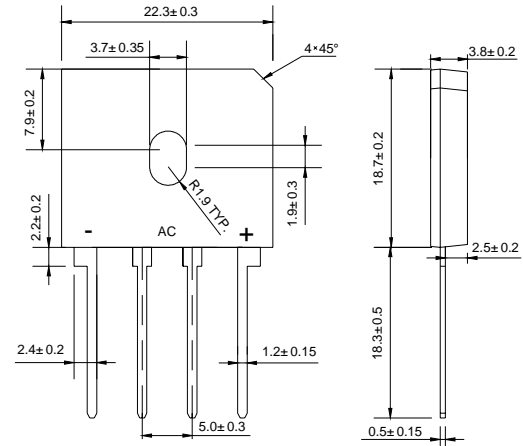

Dimensions in millimeters

## Features

- ◇ Ideal for printed circuit board
- ◇ Reliable low cost construction utilizing molded plastic technique
- ◇ Plastic material has U/L flammability classification 94V-0
- ◇ Mounting position: Any

## MAXIMUM RATINGS AND ELECTRICAL CHARACTERISTICS

Ratings at 25°C ambient temperature unless otherwise specified.

Single phase, half wave, 60 Hz, resistive or inductive load. For capacitive load, derate by 20%.

		GBU 25A	GBU 25B	GBU 25D	GBU 25G	GBU 25J	GBU 25K	GBU 25M	UNITS
Maximum recurrent peak reverse voltage	$V_{RRM}$	50	100	200	400	600	800	1000	V
Maximum RMS voltage	$V_{RMS}$	35	70	140	280	420	560	700	V
Maximum DC blocking voltage	$V_{DC}$	50	100	200	400	600	800	1000	V
Maximum average forward output current Tc=100°C	$I_{F(AV)}$	25.0							A
Peak forward surge current 8.3ms single half-sine-wave superimposed on rated load	$I_{FSM}$	340							A
Maximum instantaneous forward voltage at 12.5 A	$V_F$	1.0							V
Maximum reverse current @T <sub>A</sub> =25°C at rated DC blocking voltage @T <sub>A</sub> =125°C	$I_R$	5.0 500.0							μA mA
Typical junction capacitance per leg (note 3)	$C_J$	211				94			pF
Typical thermal resistance per leg (note 2) (note 1)	$R_{\theta JA}$ $R_{\theta JC}$	21.0 2.2							°C/W
Operating junction temperature range	$T_J$	- 55 ---- + 150							°C
Storage temperature range	$T_{STG}$	- 55 ---- + 150							°C

NOTE: 1. Unit case mounted on 3.2x3.2x0.12" thick (6.2x8.2x0.3cm) Al. Plate.

2. Units mounted in free air, no heat sink on P.C.B., 0.5x0.5"(12x12mm) copper pads, 0.375"(9.5mm) lead length.

3. Measured at 1.0 MHz and applied reverse voltage of 4.0 volts.

## Ratings AND Characteristic Curves

**FIG.1 – DERATING CURVE FOR OUTPUT RECTIFIED CURRENT**

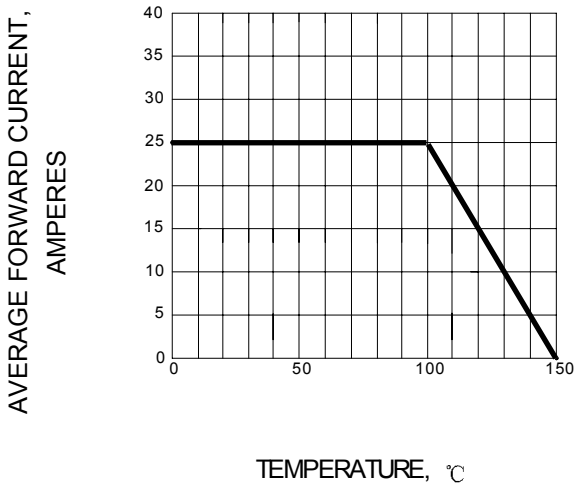

**FIG.2 – TYPICAL FORWARD CHARACTERISTIC**

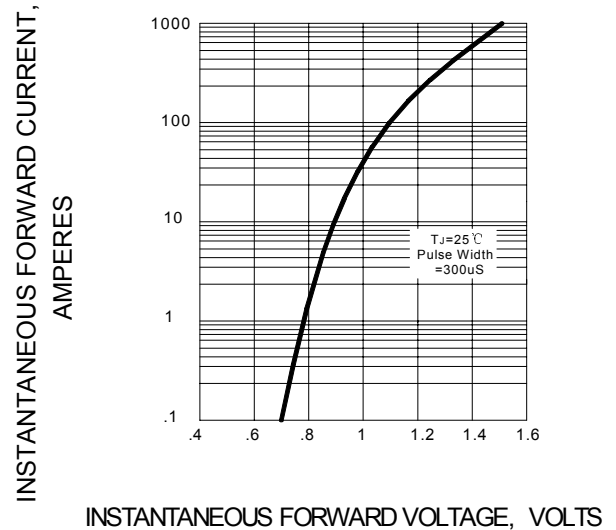

**FIG.3 – MAXIMUM NON-REPETITIVE PEAK FORWARD SURGE CURRENT**

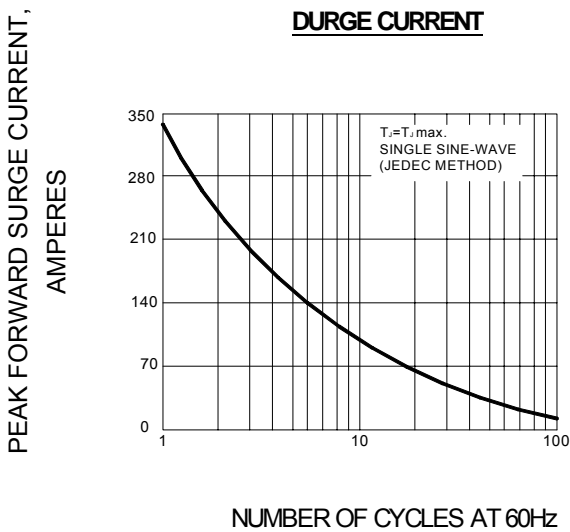

**FIG.4 – TYPICAL REVERSE CHARACTERISTIC**

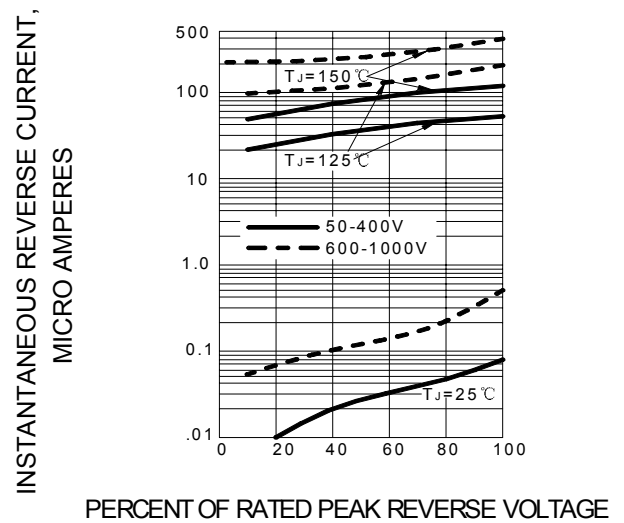

**FIG.5 – TYPICAL JUNCTION CAPACITANCE PER LEG**

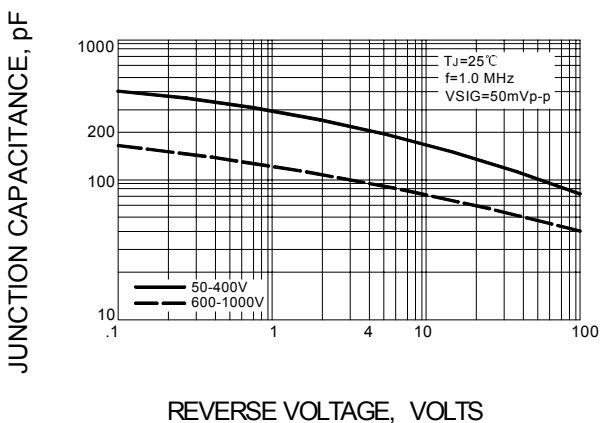

**FIG.6 – TYPICAL TRANSIENT THERMAL IMPEDANCE**

