

Features

1. Normally Open, Single Pole Single Throw
2. Control 350VAC or DC Voltage
3. Switch 130mA Loads
4. LED control Current, 5mA
5. Low ON-Resistance
6. dv/dt, >500V/ms
7. Isolation Test Voltage, 1500VACrms

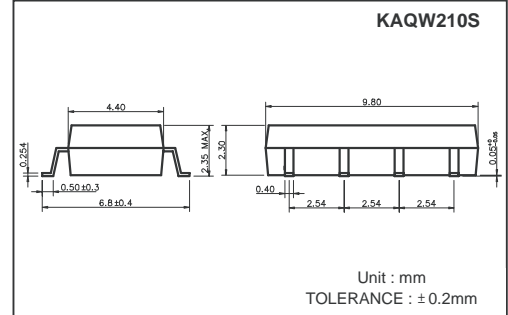

Absolute Maximum Ratings

(Ta=25°C)

| Emitter (Input) | Detector (Output) |
|--|--|
| Reverse Voltage.....5.0V | Output Breakdown Voltage±350V |
| Continuous Forward Current50mA | Continuous Load Current±130mA |
| Peak Forward Current1A | Power Dissipation500mW |
| Power Dissipation100mW | |
| Derate Linearly from 25°C1.3mW/°C | |
| General Characteristics | |
| Isolation Test Voltage.....1500VACrms | Storage Temperature Range ...-40°C to +125°C |
| Isolation Resistance | Operating Temperature Range...-30°C to +85°C |
| Vio=500V, Ta=25°C≥10 ¹⁰ Ω | Junction Temperature.....100°C |
| Total Power Dissipation550mW | Soldering Temperature, |
| Derate Linearly from 25°C2.5mW/°C | 2mm from case, 10 sec260°C |

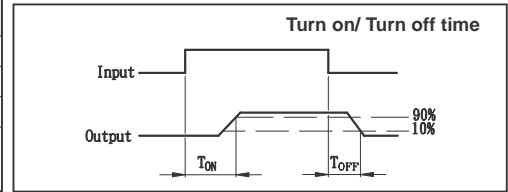

Electro-optical Characteristics

(Ta=25°C)

| Parameter | Symbol | Conditions | Min. | Typ. | Max. | Unit |
|--------------------------|-------------------|--|---------------------------------|------|------|------|
| Emitter (Input) | | | | | | |
| Forward Voltage | V _F | I _F =10mA | | 1.2 | 1.5 | V |
| Operation Input Current | I _{FON} | V _L =±20V, I _L =100mA, t =10mS | | | 5 | mA |
| Recovery Input Current | I _{FOFF} | V _L =±20V, I _L ≤5uA | 0.2 | | | mA |
| Detector (Output) | | | | | | |
| Output Breakdown Voltage | V _B | I _B =50uA | 350 | | | V |
| Output Off-State Leakage | I _{TOFF} | V _T =100V, I _F =0mA | | 0.2 | 1 | uA |
| I/O Capacitance | C _{ISO} | I _F =0, f =1MHz | | 6 | | pF |
| ON Resistance | R _{ON} | I _L =100mA, I _F =10mA | | 20 | 25 | Ω |
| Reverse (ON) Time | T _{ON} | I _F =10mA, V _L =±20V | | 0.3 | 1.0 | ms |
| Operate (OFF) Time | T _{OFF} | | t =10ms, I _L =±100mA | | 0.7 | 1.5 |

Schematic and Wiring Diagrams

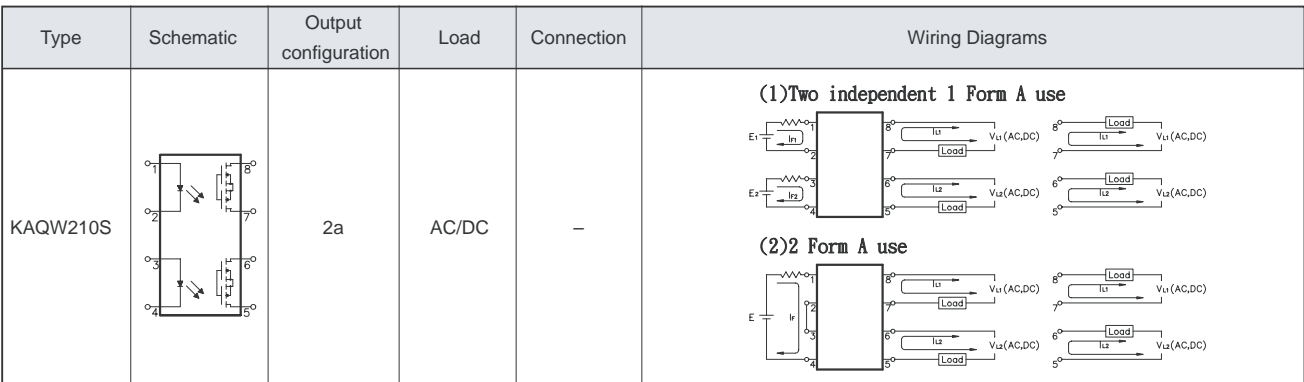

Data Curve

Fig.1 Load current vs. ambient temperature
Allowable ambient temperature:
-40°C to +85°C

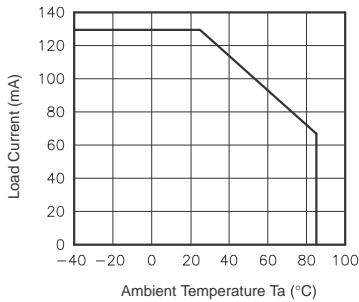

Fig.2 On resistance vs. ambient temperature
Across terminals 5,7 and 6,8 pin
LED current: 5mA
Continuous load current: 130mA(DC)

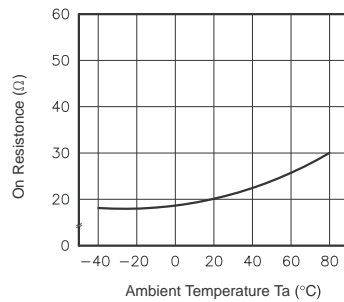

Fig.3 Turn on time vs. ambient temperature
Load voltage 350V(DC)
LED current: 5mA
Continuous load current: 130mA(DC)

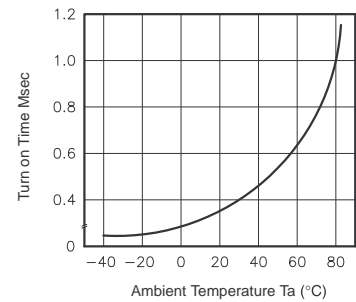

Fig.4 Turn off time vs. ambient temperature
LED current: 5mA; Load voltage:
350V(DC)
Continuous load current: 130mA(DC)

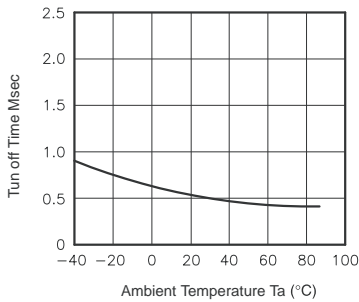

Fig.5 LED operate vs. ambient temperature
Load voltage 350V(DC)
Continuous load current: 130mA(DC)

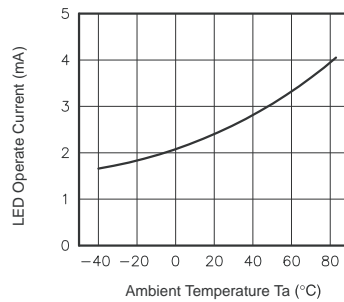

Fig.6 LED turn off current vs. ambient temperature
Load voltage 350V(DC)
Continuous load current: 130mA(DC)

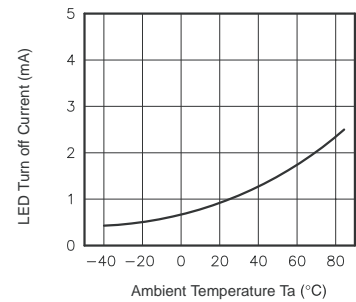

Fig.7 LED dropout voltage vs. ambient temperature
LED current: 5 to 50mA

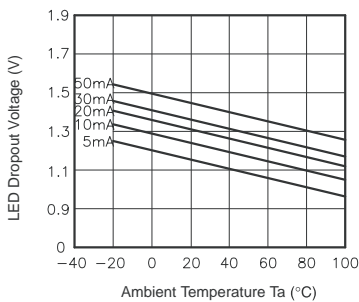

Fig.8 Voltage vs. current characteristics of output at MOS FET portion
Measured portion: across terminals 5,7 and 6,8 pin
Ambient temperature: 25°C

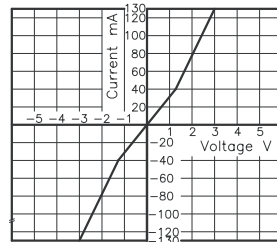

Fig.9 Off state leakage current
Across terminals 5,7 and 6,8 pin
Ambient temperature: 25°C

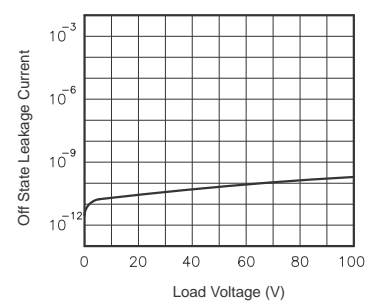

Fig.10 LED forward current vs. turn on time
Across terminals 5,7 and 6,8 pin;
Load voltage: 350V (DC);
Continuous load current: 130mA (DC);
Ambient temperature: 25°C

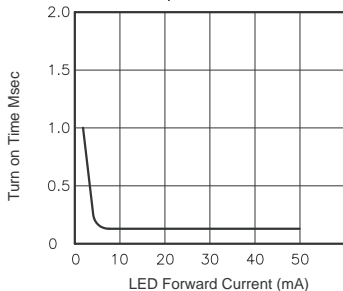

Fig.11 LED forward current vs. turn off time
Across terminals 5,7 and 6,8 pin;
Load voltage: 350V (DC);
Continuous load current: 130mA (DC);
Ambient temperature: 25°C

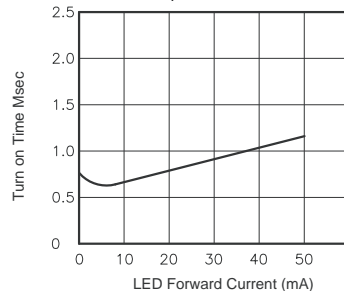

Fig.12 Applied voltage vs. output capacitance
Across terminals 5,7 and 6,8 pin
Frequency: 1MHz
Ambient temperature: 25°C

