

MORNSUN®

LD12 SERIES 12W, AC-DC CONVERTER

LD12 series ----- are the 12W compact size power converter offered by Mornsun. It features universal input voltage, taking both DC and AC input voltage, low power consumption, low ripple & noise, high efficiency, high reliability, 4000VAC safer isolation. It offers good EMC performance, meet IEC/EN61000-4, CISPR22/EN55022, UL60950 and EN60950 standards, and widely used in industrial, electricity, instruments, telecommunication and civil applications. For harsh EMC environment, this series of products must use the referred application circuit.

PRODUCT FEATURES

1. Universal input :85~264VAC/120~370VDC
2. AC and DC dual-use(input from the same terminal)
3. Super small volume
4. 4000VAC safer isolation
5. Low ripple and noise
6. High efficiency, low loss, green environmental protection
7. Output over voltage, short circuit and over current protection
8. Meet UL60950 and EN60950 standards
9. Three years warranty
10. Mounting: PCB mounting, Chassis mounting with Screw Terminals, DIN-Rail mounting



RoHS CE E235235

PART NUMBER SYSTEM

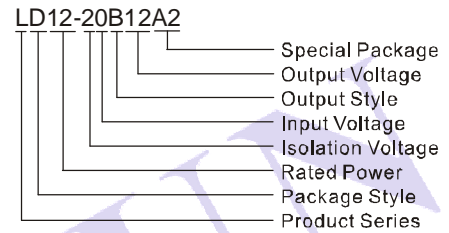

SELECTION GUIDE

Approval	Model	Package	Power	Output (Vo/Io)	Ripple and Noise (typ.)	Efficiency (%) (typ.)	Standby Power (max.)
UL/CE	LD12-20B03	53.8x28.8x23.5mm	7.9W	3.3V/2400mA	50mV	74	0.3W
	LD12-20B05		5V/2400mA	78			
	LD12-20B12		12W	12V/1000mA		82	
	LD12-20B15		15V/800mA	82			
	LD12-20B24		24V/500mA	83			

INPUT SPECIFICATIONS

Input voltage range	85~264VAC, 120~370VDC
Input frequency	47~440Hz
Input current	110VAC 280mA, typ 230VAC 190mA, typ
Inrush current	110VAC 10A, typ 230VAC 20A, typ
Recommended External Input Fuse (Special package series include fuse)	3.15A/250V Slow-Blow

OUTPUT SPECIFICATIONS

Voltage set accuracy	±2%
Input variation	±0.5% (typ)
Load variation (10% to 100% load)	±1% (typ)
Min load	0%
Ripple & noise (p-p)	(20MHz Bandwidth) 100mV (max)
Short circuit protection	Continuous, and auto resume
Over current protection	≥110% Io and auto resume
Over voltage protection	Zener diode clamp

Maximum capacitive load (μF)	LD12-20B03	10000
	LD12-20B05	10000
	LD12-20B12	5400
	LD12-20B15	2700
	LD12-20B24	1500

COMMON SPECIFICATIONS

Temperature ranges	Operating	-40°C ~ +70°C		
	Power derating	(55°C ~ 70°C)	3.3% / °C	
		(-40°C ~ 0°C)	1% / °C	
	Storage	-40°C ~ +105°C		
Case temperature	+90°C max			
Hold-up time	(Vin=230VAC)	50ms(typ)		
	(Vin=115VAC)	10ms(typ)		
Humidity	95%(max)			
Temperature coefficient	±0.02%/°C			
Switching frequency	100KHz(typ)			
I/O-isolation voltage	4000VAC/1Min			
EMC	EMI	CE	CISPR22/EN55022, CLASS B(without external circuit)	
		RE	CISPR22/EN55022, CLASS B(without external circuit)	
	EMS	ESD	IEC/EN 61000-4-2 Contact ±6KV /Air ±8KV	perf. Criteria B
		RS	IEC/EN 61000-4-3 10V/m	perf. Criteria A
		EFT	IEC/EN 61000-4-4 ±4KV(without external circuit)	perf. Criteria B
		Surge	IEC/EN 61000-4-5 ±2KV(without external circuit)	perf. Criteria B
			IEC/EN 61000-4-5 ±4KV/±6KV (with typical applications Figure 3)	perf. Criteria B
		CS	IEC/EN61000-4-6 10 Vr.m.s	perf. Criteria A
		PFM	IEC/EN61000-4-8 10A/m	perf. Criteria A
		Voltage dips, short and interruptions immunity	IEC/EN61000-4-11 0%-70%	perf. Criteria B
Safety standards	IEC60950/EN60950/UL60950			
Safety approvals	EN60950/UL60950			
Safety class	CLASS II			
Case material	UL94V-0			
Install	PCB mounting, Chassis mounting with Screw Terminals, DIN-Rail mounting			
Cooling	Free air convection			
MTBF	>300,000H @25°C			
Package	PCB mounting	53.8x28.8x23.5mm		
	Chassis mounting with Screw Terminals	96.1X54.0X32.0mm		
	DIN-Rail mounting	96.1X54.0X36.6mm		
Weight		60g(PCB mounting)		
		110g(Chassis mounting with Screw Terminals)		
		150g(DIN-Rail mounting)		
Note:				
1. Ripple and Noise were measured by the method of anear measure;				
2. All specifications measured at Ta=25°C, humidity<75%, nominal input voltage and rated output load unless otherwise specified.				

PARALLEL LINES MEASURE

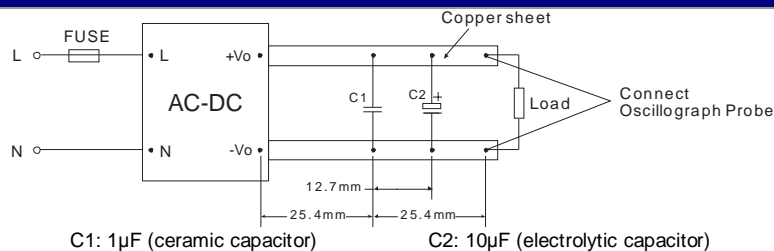

TEMPERATURE VS LOAD

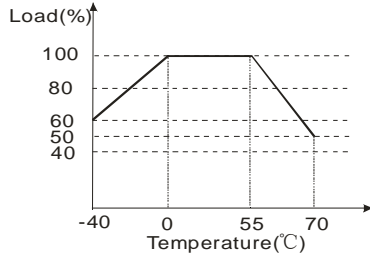

INPUT VOLTAGE VS LOAD

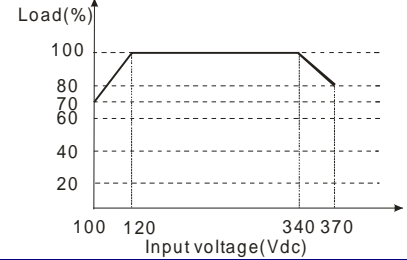
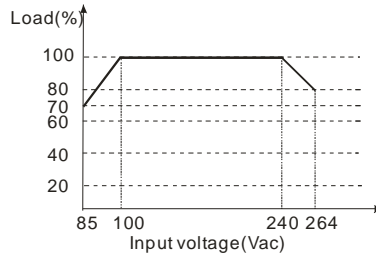

TYPICAL APPLICATIONS

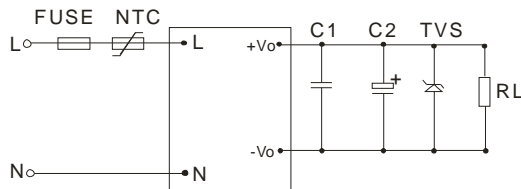

Figure 1: LD12-20BXX EMC application circuit

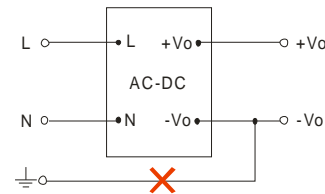

Figure 2: Note: This application is not supported for this series.

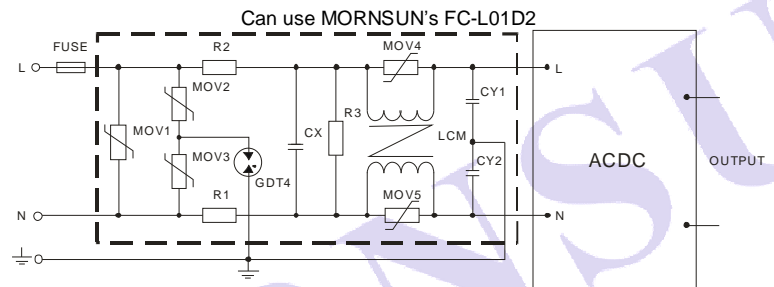

Figure 3: LD12 series Recommended circuit for application require higher EMC standard (external circuit output same as above)

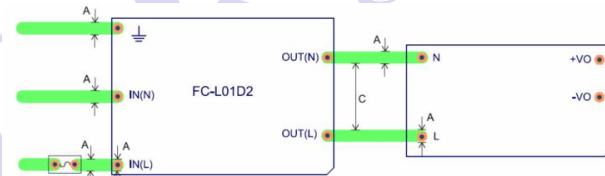

Figure 4: EMC application circuit PCB layout
Safety and recommend wiring: linewidth A≥3mm, C≥9mm

EXTERNAL CIRCUIT PARAMETERS

Model	C1	C2	TVS
LD12-20B03	1μF /50V	220μF /10V	SMBJ7.0A
LD12-20B05	1μF /50V	220μF /10V	SMBJ7.0A
LD12-20B12	1μF /50V	120μF /25V	SMBJ20A
LD12-20B15	1μF /50V	120μF /25V	SMBJ20A
LD12-20B24	1μF /50V	68μF/50V	SMBJ30A

Note:

1. C1 is ceramic capacitor, it is used to filter high frequency noise. Output filtering capacitors C2 is electrolytic capacitors, It is recommended to use high frequency and low impedance electrolytic capacitors. For capacitance and current of capacitor please refer to manufacture's datasheet. Voltage derating of capacitor should be 80% or above. TVS is a recommended component to protect post-circuits (if converter fails). External input NTC model is recommended to use 5D-9.

2. For standard EMC requirement, please refer to figure 1, if higher EMC requirement, please refer to figure 3 .

MOV1: 561KD20;

MOV2、MOV3: 561KD14;

MOV4、MOV5: 561KD07;

GDT4: B5G3600;

CX: 0.15μF/300VAC;

CY1、CY2: 222M/400VAC;

R1、R2: 2Ω/3W wirewound;

R3: 1MΩ/2W;

LCM: 10mH-30mH;

FC-L01D2: 4KV/6KV Surge protector.

3. FUSE: LD12 is recommended to use 3.15A/250V.

PCB MOUNTING WITH SOLDER PINS

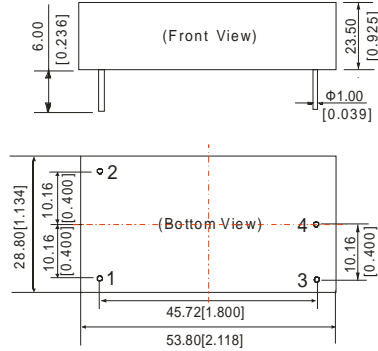

Note:
Unit: mm[inch]
Pin diameter tolerances: $\pm 0.10\text{mm}[\pm 0.004\text{inch}]$
General tolerances: $\pm 0.50\text{mm}[\pm 0.020\text{inch}]$

RECOMMENDED FOOTPRINT

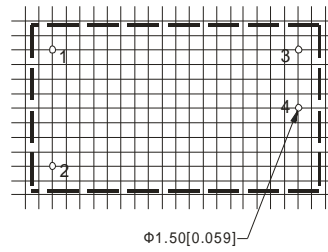

Note: grid 2.54*2.54mm.

FOOTPRINT DETAILS

PIN	FUNCTION
1	N
2	L
3	+Vo
4	-Vo

LD12XXA2 CHASSIS MOUNTING WITH SCREW TERMINALS



Footprint Details								
Pin	1	2	3	4	5	6	7	8
Function	NC	AC(N)	AC(L)	+Vo	NC	-Vo	NC	NC

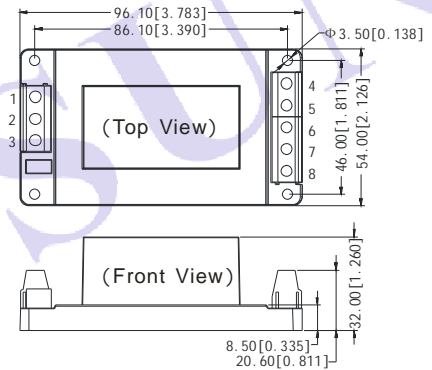

Note:
Unit: mm[inch]
General tolerances: $\pm 0.50\text{mm}[\pm 0.020\text{inch}]$

LD12XXA4 DIN-RAIL MOUNTING

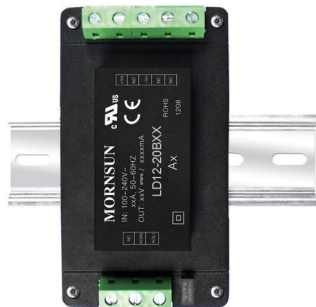

*Meet normal 35mm DIN-rail package

Footprint Details								
Pin	1	2	3	4	5	6	7	8
Function	NC	AC(N)	AC(L)	+Vo	NC	-Vo	NC	NC

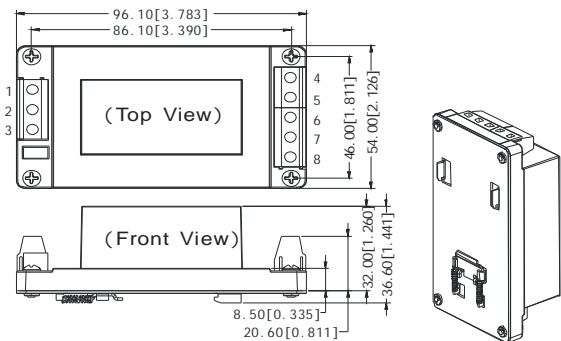

Note:
Unit: mm[inch]
General tolerances: $\pm 0.50\text{mm}[\pm 0.020\text{inch}]$

PACKAGE DIAGRAM

PCB mounting Series

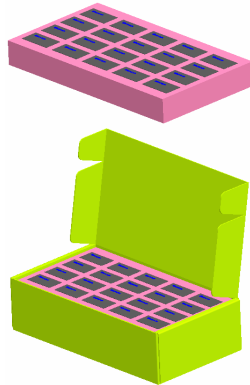

Inner packaging dimensions: L*W*H=355*192*93mm
Packaging quantity: 40pcs
Outer packaging dimensions: L*W*H=405*380*305mm
Packaging quantity: 240pcs

Special Package Series

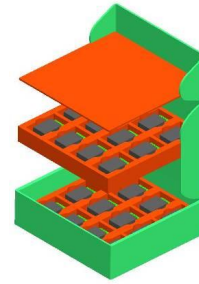

Inner packaging box dimensions: L*W*H=365*350*105mm
Packaging quantity: 24pcs
Outer packaging box dimensions: L*W*H=390*360*245mm
Packaging quantity: 48pcs

MORNSUN Science & Technology Co.,Ltd.

Address: No. 5, Kehui St. 1, Kehui development center, Science Ave., Guangzhou Science City, Luogang district, Guangzhou, P.R.China.

Tel: 86-20-28203030

Fax: 86-20-38601272

[Http://www.mornsun-power.com](http://www.mornsun-power.com)

MORNSUN