

BB189

UHF variable capacitance diode

Rev. 01 — 8 June 2009

Product data sheet

1. Product profile

1.1 General description

The BB189 is a planar technology variable capacitance diode in a SOD523 ultra small leadless plastic SMD package. The excellent matching performance is achieved by gliding matching and a Direct Matching Assembly (DMA) procedure.

1.2 Features



- Excellent linearity
- Excellent matching to 1.8 % DMA
- Ultra small plastic SMD package
- $C_{d(25V)}$: 2.05 pF; $C_{d(2V)}$ to $C_{d(25V)}$ ratio: 6.3 min.
- Low series resistance

1.3 Applications

- Voltage Controlled Oscillators (VCO)
- Electronic tuning in UHF television tuners

2. Pinning information

Table 1. Pinning

Pin	Description	Simplified outline	Graphic symbol
1	cathode	[1]	
2	anode		

sym008

[1] The marking bar indicates the cathode.

3. Ordering information

Table 2. Ordering information

Type number	Package		Version
	Name	Description	
BB189	SC-79	plastic surface-mounted package; 2 leads	SOD523

4. Marking

Table 3. Marking codes

Type number	Marking code
BB189	4

5. Limiting values

Table 4. Limiting values

In accordance with the Absolute Maximum Rating System (IEC 60134).

Symbol	Parameter	Conditions	Min	Max	Unit
V_R	reverse voltage		-	32	V
I_F	forward current		-	20	mA
T_{stg}	storage temperature		-55	+150	°C
T_j	junction temperature		-55	+125	°C

6. Characteristics

Table 5. Characteristics

$T_j = 25\text{ °C}$ unless otherwise specified

Symbol	Parameter	Conditions	Min	Typ	Max	Unit
I_R	reverse current	see Figure 2				
		$V_R = 30\text{ V}$	-	-	10	nA
		$V_R = 30\text{ V}; T_j = 85\text{ °C}$	-	-	200	nA
r_s	diode series resistance	$f = 470\text{ MHz}$ at $C_d = 9\text{ pF}$	-	0.6	0.7	Ω
C_d	diode capacitance	$f = 1\text{ MHz}$; see Figure 1 and Figure 3				
		$V_R = 2\text{ V}$	14.15	-	15.75	pF
		$V_R = 25\text{ V}$	1.89	-	2.18	pF
$C_{d(2V)}/C_{d(25V)}$	diode capacitance ratio (2 V to 25 V)	$f = 1\text{ MHz}$	6.3	-	-	
$\Delta C_d/C_d$	diode capacitance matching	$V_R = 2\text{ V to }25\text{ V}$; in sequence of 10 diodes (gliding)	-	-	1.8	%

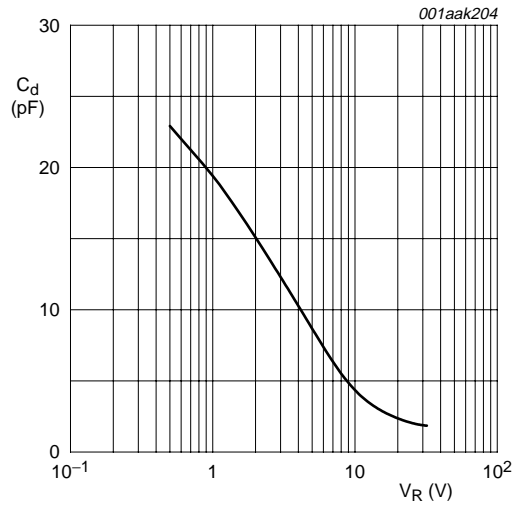

Fig 1. Diode capacitance as a function of reverse voltage; typical values

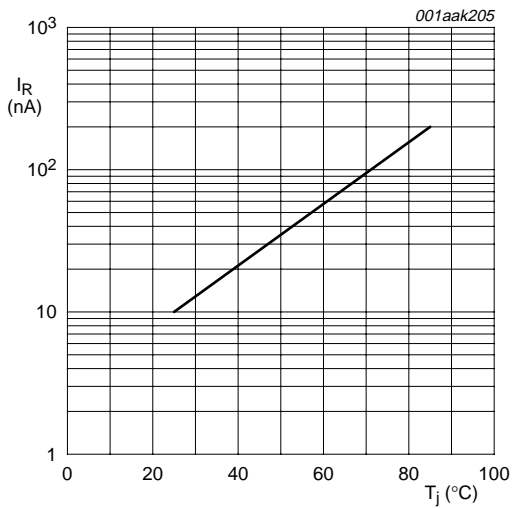
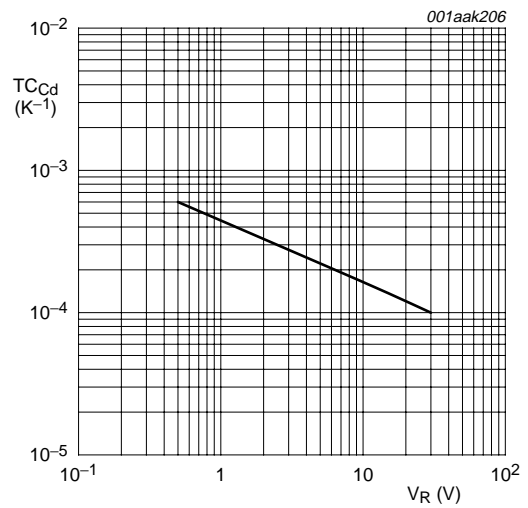

Fig 2. Reverse current as a function of junction temperature; maximum values



$T_j = 0\text{ }^\circ\text{C}$ to $85\text{ }^\circ\text{C}$.

Fig 3. Temperature coefficient of diode capacitance as a function of reverse voltage; typical values

7. Package outline

Plastic surface-mounted package; 2 leads

SOD523

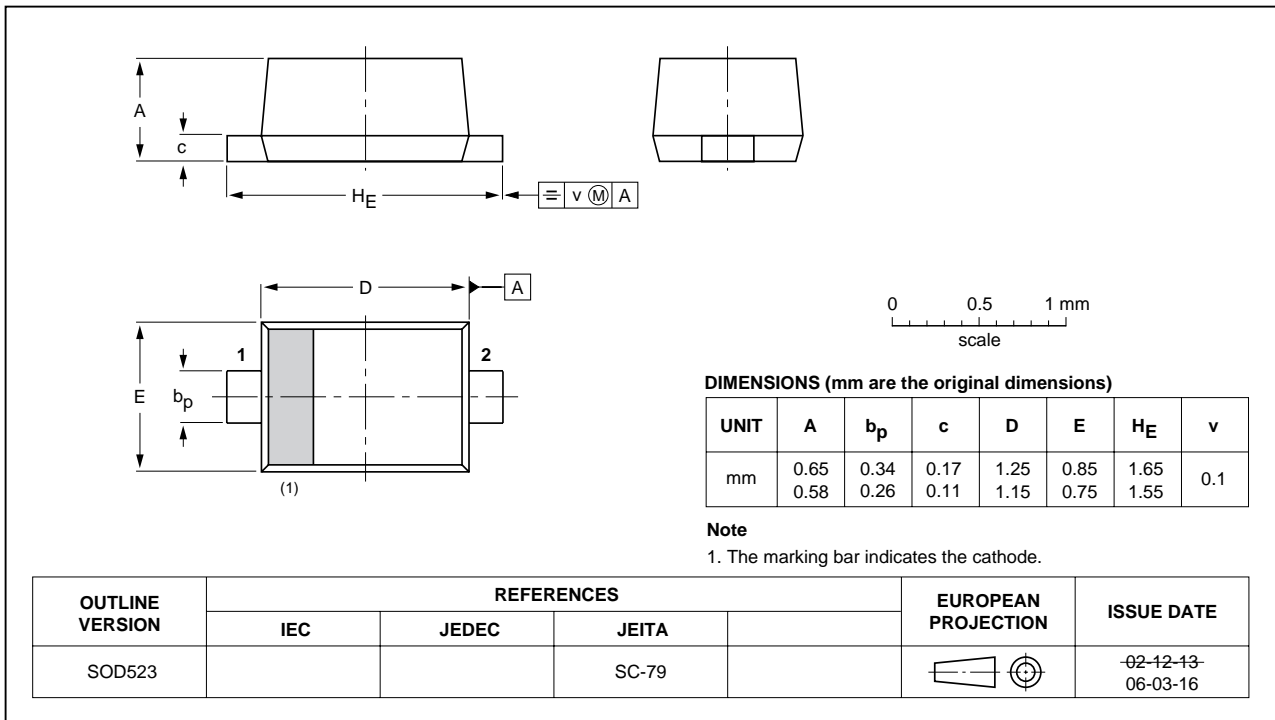

Fig 4. Package outline SOD523 (SC-79)

8. Abbreviations

Table 6. Abbreviations

Acronym	Description
SMD	Surface Mounted Device
UHF	Ultra High Frequency

9. Revision history

Table 7. Revision history

Document ID	Release date	Data sheet status	Change notice	Supersedes
BB189_1	20090608	Product data sheet	-	-

10. Legal information

10.1 Data sheet status

Document status ^{[1][2]}	Product status ^[3]	Definition
Objective [short] data sheet	Development	This document contains data from the objective specification for product development.
Preliminary [short] data sheet	Qualification	This document contains data from the preliminary specification.
Product [short] data sheet	Production	This document contains the product specification.

[1] Please consult the most recently issued document before initiating or completing a design.

[2] The term 'short data sheet' is explained in section "Definitions".

[3] The product status of device(s) described in this document may have changed since this document was published and may differ in case of multiple devices. The latest product status information is available on the Internet at URL <http://www.nxp.com>.

10.2 Definitions

Draft — The document is a draft version only. The content is still under internal review and subject to formal approval, which may result in modifications or additions. NXP Semiconductors does not give any representations or warranties as to the accuracy or completeness of information included herein and shall have no liability for the consequences of use of such information.

Short data sheet — A short data sheet is an extract from a full data sheet with the same product type number(s) and title. A short data sheet is intended for quick reference only and should not be relied upon to contain detailed and full information. For detailed and full information see the relevant full data sheet, which is available on request via the local NXP Semiconductors sales office. In case of any inconsistency or conflict with the short data sheet, the full data sheet shall prevail.

10.3 Disclaimers

General — Information in this document is believed to be accurate and reliable. However, NXP Semiconductors does not give any representations or warranties, expressed or implied, as to the accuracy or completeness of such information and shall have no liability for the consequences of use of such information.

Right to make changes — NXP Semiconductors reserves the right to make changes to information published in this document, including without limitation specifications and product descriptions, at any time and without notice. This document supersedes and replaces all information supplied prior to the publication hereof.

Suitability for use — NXP Semiconductors products are not designed, authorized or warranted to be suitable for use in medical, military, aircraft, space or life support equipment, nor in applications where failure or malfunction of an NXP Semiconductors product can reasonably be expected to result in personal injury, death or severe property or environmental

damage. NXP Semiconductors accepts no liability for inclusion and/or use of NXP Semiconductors products in such equipment or applications and therefore such inclusion and/or use is at the customer's own risk.

Applications — Applications that are described herein for any of these products are for illustrative purposes only. NXP Semiconductors makes no representation or warranty that such applications will be suitable for the specified use without further testing or modification.

Limiting values — Stress above one or more limiting values (as defined in the Absolute Maximum Ratings System of IEC 60134) may cause permanent damage to the device. Limiting values are stress ratings only and operation of the device at these or any other conditions above those given in the Characteristics sections of this document is not implied. Exposure to limiting values for extended periods may affect device reliability.

Terms and conditions of sale — NXP Semiconductors products are sold subject to the general terms and conditions of commercial sale, as published at <http://www.nxp.com/profile/terms>, including those pertaining to warranty, intellectual property rights infringement and limitation of liability, unless explicitly otherwise agreed to in writing by NXP Semiconductors. In case of any inconsistency or conflict between information in this document and such terms and conditions, the latter will prevail.

No offer to sell or license — Nothing in this document may be interpreted or construed as an offer to sell products that is open for acceptance or the grant, conveyance or implication of any license under any copyrights, patents or other industrial or intellectual property rights.

Export control — This document as well as the item(s) described herein may be subject to export control regulations. Export might require a prior authorization from national authorities.

10.4 Trademarks

Notice: All referenced brands, product names, service names and trademarks are the property of their respective owners.

11. Contact information

For more information, please visit: <http://www.nxp.com>

For sales office addresses, please send an email to: salesaddresses@nxp.com

12. Contents

1	Product profile	1
1.1	General description	1
1.2	Features	1
1.3	Applications	1
2	Pinning information	1
3	Ordering information	1
4	Marking	2
5	Limiting values	2
6	Characteristics	2
7	Package outline	4
8	Abbreviations	4
9	Revision history	4
10	Legal information	5
10.1	Data sheet status	5
10.2	Definitions	5
10.3	Disclaimers	5
10.4	Trademarks	5
11	Contact information	5
12	Contents	6

Please be aware that important notices concerning this document and the product(s) described herein, have been included in section 'Legal information'.



© NXP B.V. 2009.

All rights reserved.

For more information, please visit: <http://www.nxp.com>

For sales office addresses, please send an email to: salesaddresses@nxp.com

Date of release: 8 June 2009

Document identifier: BB189_1