

TOSHIBA Integrated IGBT Module Silicon N Channel IGBT

MIG150J202H

High Power Switching Applications

Motor Control Applications

- Integrates inverter, brake power circuits & control circuits (IGBT drive units, protection units for over-current, under-voltage & over-temperature) in one package.
- The electrodes are isolated from case.
- High speed type IGBT : $V_{CE(sat)} = 2.8V$ (max)
 $t_{off} = 3.0 \mu s$ (max)
 $t_{rr} = 0.30 \mu s$ (max)
- Package dimensions : TOSHIBA 2-110A1A
- Weight : 520g

Equivalent Circuit

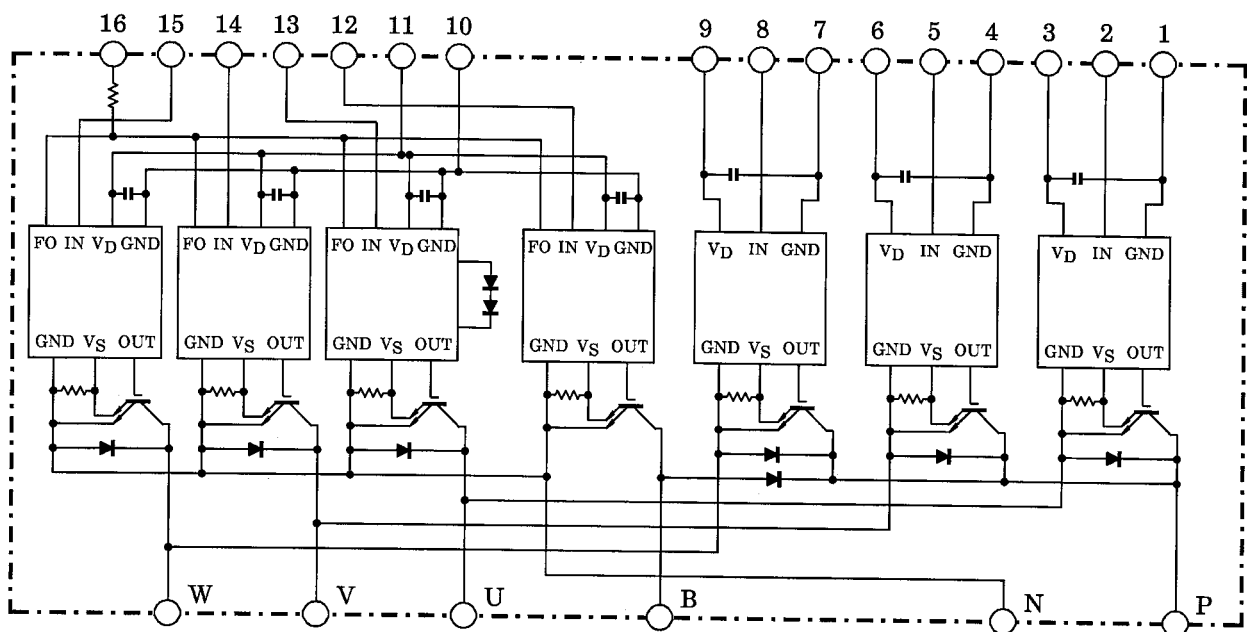

- | | | | | | |
|------------|------------|--------------|-------------|---------------|--------------|
| 1. GND (U) | 2. IN (U) | 3. V_D (U) | 4. GND (V) | 5. IN (V) | 6. V_D (V) |
| 7. GND (W) | 8. IN (W) | 9. V_D (W) | 10. GND (L) | 11. V_D (L) | 12. IN (B) |
| 13. IN (X) | 14. IN (Y) | 15. IN (Z) | 16. FO | | |

Maximum Ratings ($T_j = 25^\circ\text{C}$)

Stage	Characteristic	Condition	Symbol	Ratings	Unit
Inverter	Supply voltage	P-N power terminal	V_{CC}	450	V
	Collector-emitter voltage	—	V_{CES}	600	V
	Collector current	$T_c = 25^\circ\text{C}$, DC	I_C	150	A
	Forward current	$T_c = 25^\circ\text{C}$, DC	I_F	150	A
	Collector power dissipation	$T_c = 25^\circ\text{C}$	P_C	320	W
	Junction temperature	—	T_j	150	$^\circ\text{C}$
Brake	Supply voltage	P-N power terminal	V_{CC}	450	V
	Collector-emitter voltage	—	V_{CES}	600	V
	Collector current	$T_c = 25^\circ\text{C}$, DC	I_C	50	A
	Reverse voltage	—	V_R	600	V
	Forward current	$T_c = 25^\circ\text{C}$, DC	I_F	50	A
	Collector power dissipation	$T_c = 25^\circ\text{C}$	P_C	120	W
	Junction temperature	—	T_j	150	$^\circ\text{C}$
Control	Control supply voltage	V_D -GND terminal	V_D	20	V
	Input voltage	IN-GND terminal	V_{IN}	20	V
	Fault output voltage	FO-GND (L) terminal	V_{FO}	20	V
	Fault output current	FO sink current	I_{FO}	14	mA
Module	Operating temperature	—	TC	-20 ~ 100	$^\circ\text{C}$
	Storage temperature range	—	T_{stg}	-40 ~ +125	$^\circ\text{C}$
	Isolation voltage	AC 1 minute	V_{ISO}	2500	V
	Screw torque	M5	—	3	N·m

Electrical Characteristics ($T_j = 25^\circ\text{C}$)

a. Inverter Stage

Characteristic	Symbol	Test Condition	Min	Typ.	Max	Unit	
Collector cut-off current	I_{CEX}	$V_{CE} = 600\text{ V}$	$T_j = 25^\circ\text{C}$	—	—	1	mA
			$T_j = 125^\circ\text{C}$	—	—	20	
Collector-emitter saturation voltage	$V_{CE(sat)}$	$V_D = 15\text{ V}$, $I_C = 150\text{ A}$ $V_{IN} = 15\text{ V} \rightarrow 0\text{ V}$	$T_j = 25^\circ\text{C}$	—	2.2	2.8	V
			$T_j = 125^\circ\text{C}$	—	2.3	—	
Forward voltage	V_F	$I_F = 150\text{ A}$	—	2.5	3.5	V	
Switching time	t_{on}	$V_{CC} = 300\text{ V}$, $I_C = 150\text{ A}$ $V_D = 15\text{ V}$, $V_{IN} = 15\text{ V} \leftrightarrow 0\text{ V}$ Inductive load (Note 1)	—	1.2	2.0	μs	
	t_{off}		—	2.0	3.0		
	t_f		—	0.25	0.5		
	t_{rr}		—	0.1	0.3		

b. Brake Stage

Characteristic	Symbol	Test Condition	Min	Typ.	Max	Unit	
Collector cut-off current	I_{CEX}	$V_{CE} = 600V$	$T_j = 25^\circ C$	—	—	1	mA
			$T_j = 125^\circ C$	—	—	20	
Collector-emitter saturation voltage	$V_{CE(sat)}$	$V_D = 15V, I_C = 50A$ $V_{IN} = 15V \rightarrow 0V$	$T_j = 25^\circ C$	—	2.0	3.0	V
			$T_j = 125^\circ C$	—	2.0	—	
Reverse current	I_R	$V_R = 600V$	$T_j = 25^\circ C$	—	—	1	mA
			$T_j = 125^\circ C$	—	—	20	
Forward voltage	V_F	$I_F = 50A$	—	2.2	2.5	V	
Switching time	t_{on}	$V_{CC} = 300V, I_C = 50A$ $V_D = 15V, V_{IN} = 15V \leftrightarrow 0V$ Inductive load (Note 1)	—	1.0	2.0	μs	
	t_{off}		—	2.0	3.0		
	t_f		—	0.25	0.5		
	t_{rr}		—	0.15	0.3		

c. Control Stage ($T_j = 25^\circ C$)

Characteristic	Symbol	Test Condition	Min	Typ.	Max	Unit	
Control circuit current	High side	$V_D = 15V$	—	8	—	mA	
	Low side		$I_D(L)$	—	32		—
Input-on signal voltage	$V_{IN(on)}$	$V_D = 15V, I_C = 150mA$	1.3	1.5	1.7	V	
Input-off signal voltage	$V_{IN(off)}$	$V_D = 15V, I_C = 150mA$	2.2	2.5	2.8	V	
Fault output current	Protection	$V_D = 15V$	$I_{FO(on)}$	8	10	12	mA
	Normal		$I_{FO(off)}$	—	—	1	
Over current protection trip level	Inverter	$V_D = 15V, T_j = 125^\circ C$	OC	190	300	—	A
	Brake			60	—	—	
Short current protection trip level	Inverter	$V_D = 15V, T_j = 125^\circ C$	SC	285	450	—	A
	Brake			90	—	—	
Over current cut-off time	$t_{off(OC)}$	$V_D = 15V$	—	5	—	μs	
Over temperature protection	Trip level	Case temperature	OT	110	118	125	$^\circ C$
	Reset level			OTr	—	98	
Control supply under voltage protection	Trip level	—	UV	11.0	12.0	12.5	V
	Reset level			UVr	—	12.5	
Fault output pulse width	t_{FO}	$V_D = 15V$	1	2	3	ms	

d. Thermal Resistance ($T_j = 25^\circ\text{C}$)

Characteristic	Symbol	Test Condition	Min	Typ.	Max	Unit
Junction to case thermal resistance	$R_{th(j-c)}$	Inverter IGBT	—	—	0.390	$^\circ\text{C/W}$
		Inverter FRD	—	—	1.041	
		Brake IGBT	—	—	1.041	
		Brake FRD	—	—	2.000	
Case to fin thermal resistance	$R_{th(c-f)}$	Compound is applied	—	0.05	—	$^\circ\text{C/W}$

Note 1 : Switching time test circuit & timing chart

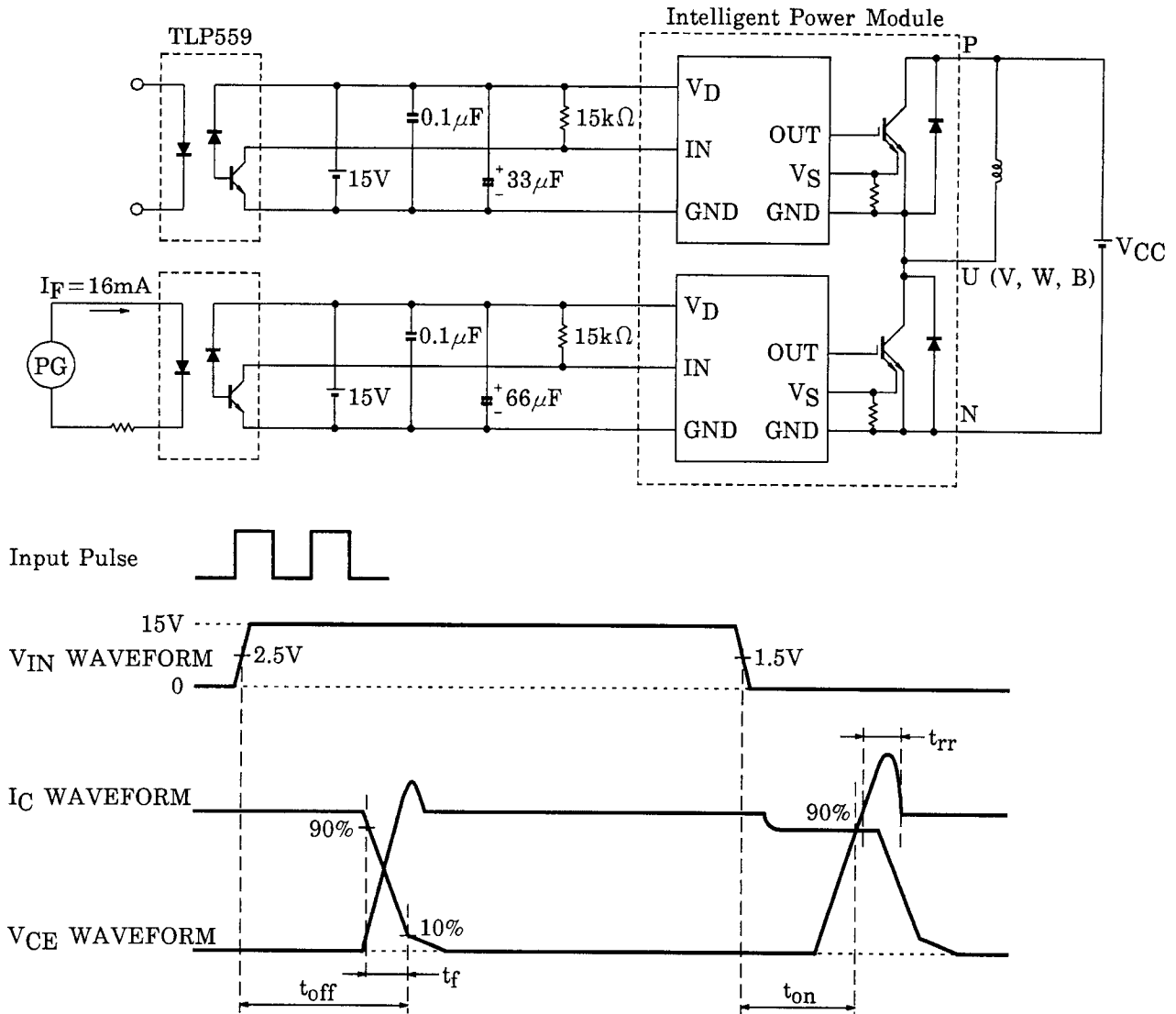

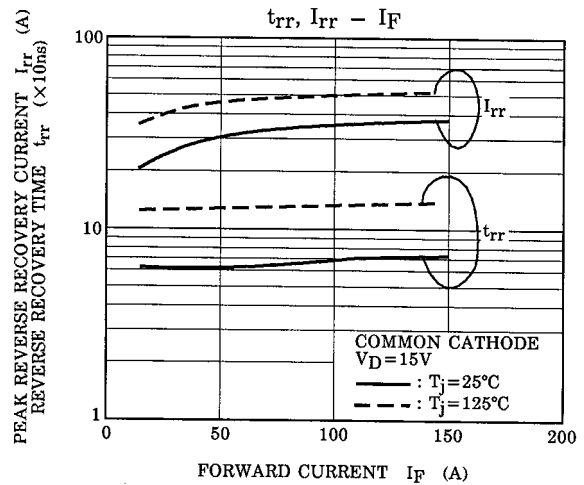
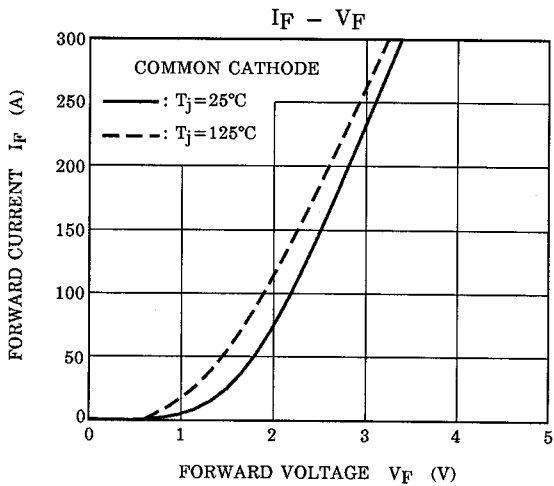
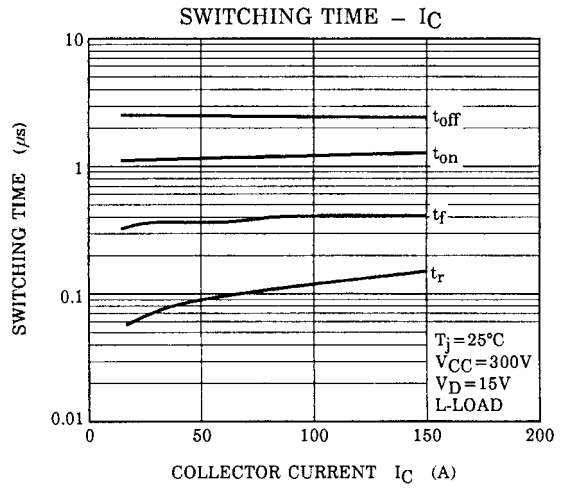
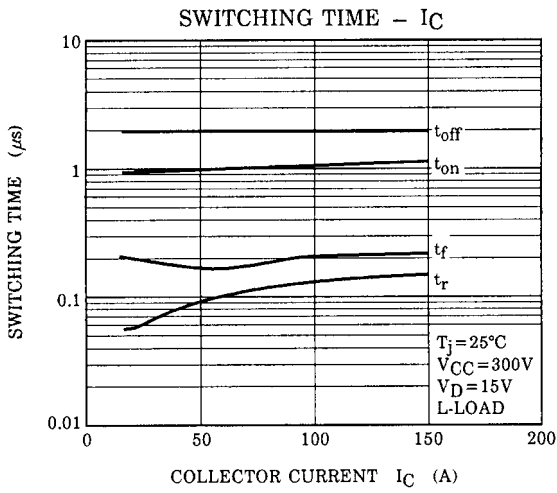
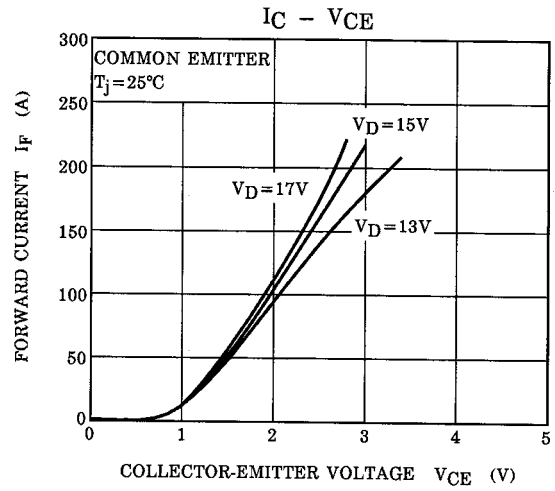
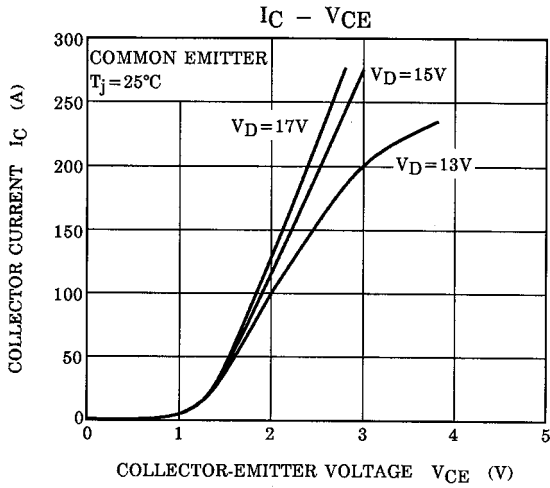

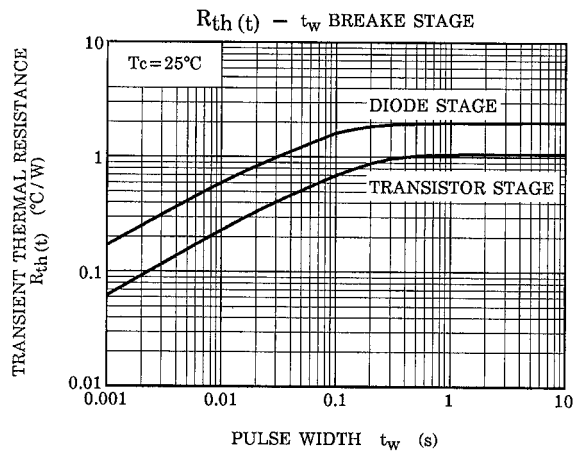
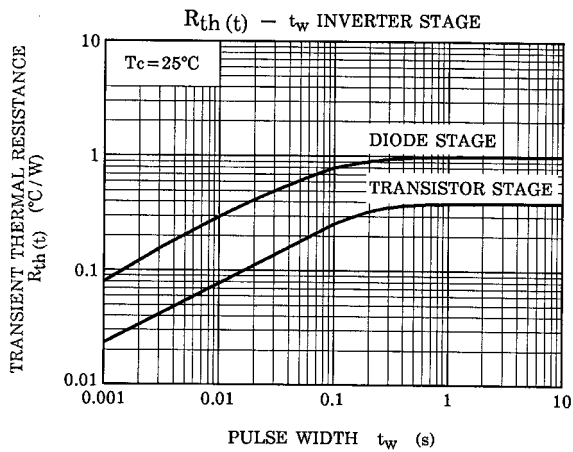
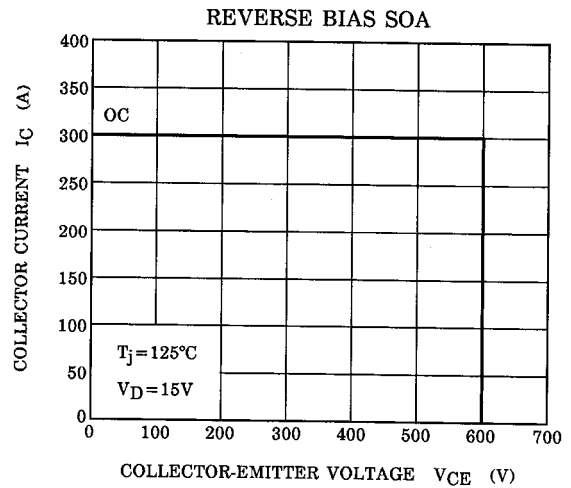
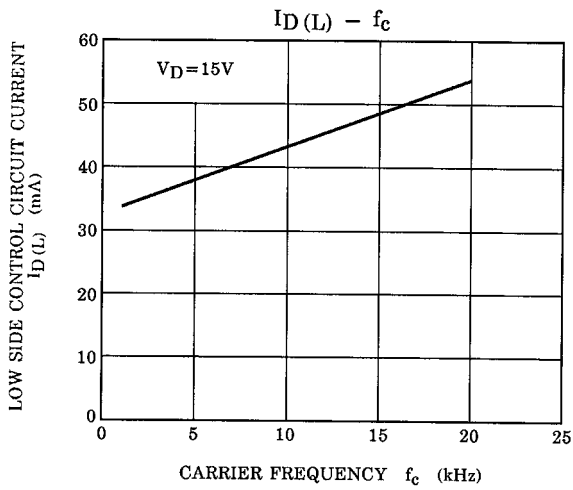
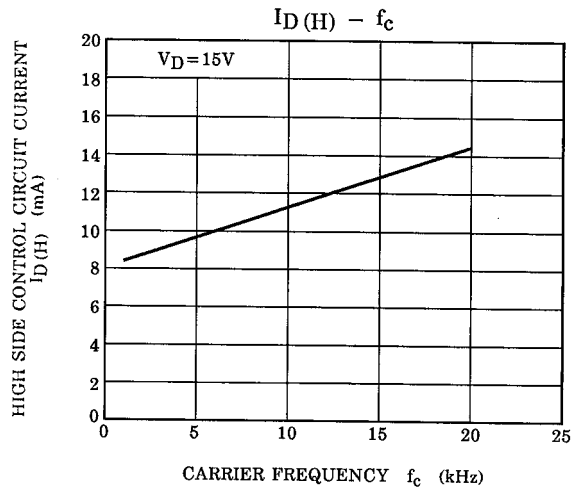
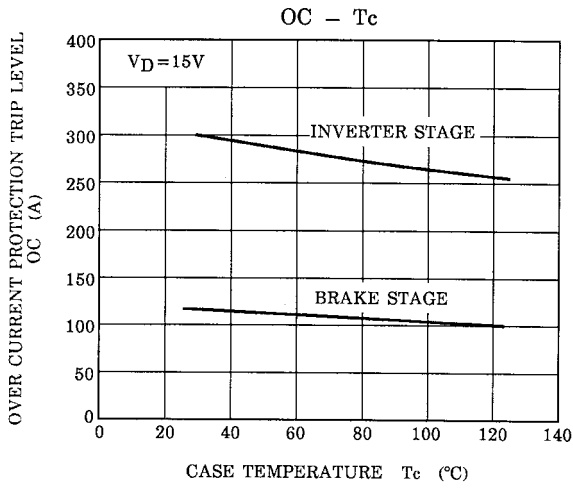

RESTRICTIONS ON PRODUCT USE

000707EAA

- TOSHIBA is continually working to improve the quality and reliability of its products. Nevertheless, semiconductor devices in general can malfunction or fail due to their inherent electrical sensitivity and vulnerability to physical stress. It is the responsibility of the buyer, when utilizing TOSHIBA products, to comply with the standards of safety in making a safe design for the entire system, and to avoid situations in which a malfunction or failure of such TOSHIBA products could cause loss of human life, bodily injury or damage to property.
In developing your designs, please ensure that TOSHIBA products are used within specified operating ranges as set forth in the most recent TOSHIBA products specifications. Also, please keep in mind the precautions and conditions set forth in the "Handling Guide for Semiconductor Devices," or "TOSHIBA Semiconductor Reliability Handbook" etc..
- The TOSHIBA products listed in this document are intended for usage in general electronics applications (computer, personal equipment, office equipment, measuring equipment, industrial robotics, domestic appliances, etc.). These TOSHIBA products are neither intended nor warranted for usage in equipment that requires extraordinarily high quality and/or reliability or a malfunction or failure of which may cause loss of human life or bodily injury ("Unintended Usage"). Unintended Usage include atomic energy control instruments, airplane or spaceship instruments, transportation instruments, traffic signal instruments, combustion control instruments, medical instruments, all types of safety devices, etc.. Unintended Usage of TOSHIBA products listed in this document shall be made at the customer's own risk.
- The information contained herein is presented only as a guide for the applications of our products. No responsibility is assumed by TOSHIBA CORPORATION for any infringements of intellectual property or other rights of the third parties which may result from its use. No license is granted by implication or otherwise under any intellectual property or other rights of TOSHIBA CORPORATION or others.
- The information contained herein is subject to change without notice.