

# Preliminary



- Low Loss RF SAW Filter
- Excellent Out-of-Band Rejection
- 2.0 x 1.6 mm Surface-Mount Case
- Complies with Directive 2002/95/EC (RoHS)



**SF2209H**

**2017.5 MHz  
SAW Filter**

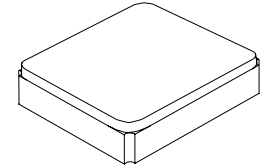

**SM2016-4**

## Absolute Maximum Ratings

Rating	Value	Units
Maximum Incident Power in Passband	+10	dBm
Maximum DC Voltage On any Non-ground Terminal	3	VDC
Operating Temperature Range	-30 to +85	°C
Storage Temperature Range in Tape and Reel	-40 to +85	°C
Maximum Soldering Temperature Profile (5 cycles maximum)	265 °C for 10 s	

## Electrical Characteristics

Characteristic	Sym	Notes	Min	Typ	Max	Units
Center Frequency	$f_c$			2017.5		MHz
Insertion Loss, 2010 to 2025 MHz	IL			1.25	2.20	dB
Amplitude Ripple, 2010 to 2025 MHz				0.1	1.0	dB <sub>P-P</sub>
Rejection Referenced to 0 dB						dB
0.1 to 1020 MHz			30	33		
1020 to 1570 MHz			20	33		
1570 to 1590 MHz			30	34		
1590 to 1820 MHz			20	34		
1820 to 1850 MHz			31	34		
1850 to 1950 MHz			20	27		
2085 to 2400 MHz			19	21		
2400 to 2430 MHz			29	33		
2430 to 2790 MHz			25	32		
2790 to 2820 MHz			30	32		
2820 to 3000 MHz			25	34		
3000 to 4010 MHz			20	32		
4010 to 4060 MHz			25	32		
4060 to 6000 MHz			10	22		
VSWR, 2010 to 2025 MHz				1.35	1.90	
Terminating Source impedance	$Z_S$			50		$\Omega$
Terminating Load impedance	$Z_L$			50		$\Omega$
Case Style			SM2016-4			
Lid Symbolization (Y=year, W=week)			3J, YW			



**CAUTION: Electrostatic Sensitive Device. Observe precautions for handling.**

### Notes:

1. US and international patents may apply.
2. RFM, stylized RFM logo, and RF Monolithics, Inc. are registered trademarks of RF Monolithics, Inc.

# Frequency Response Plots

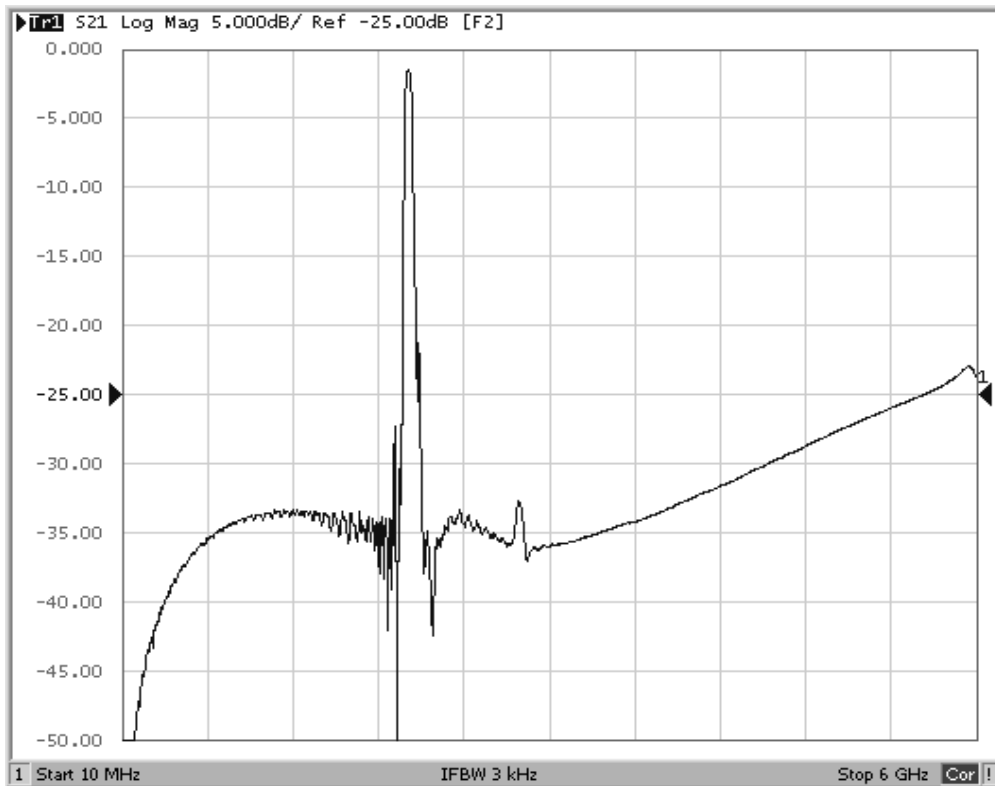
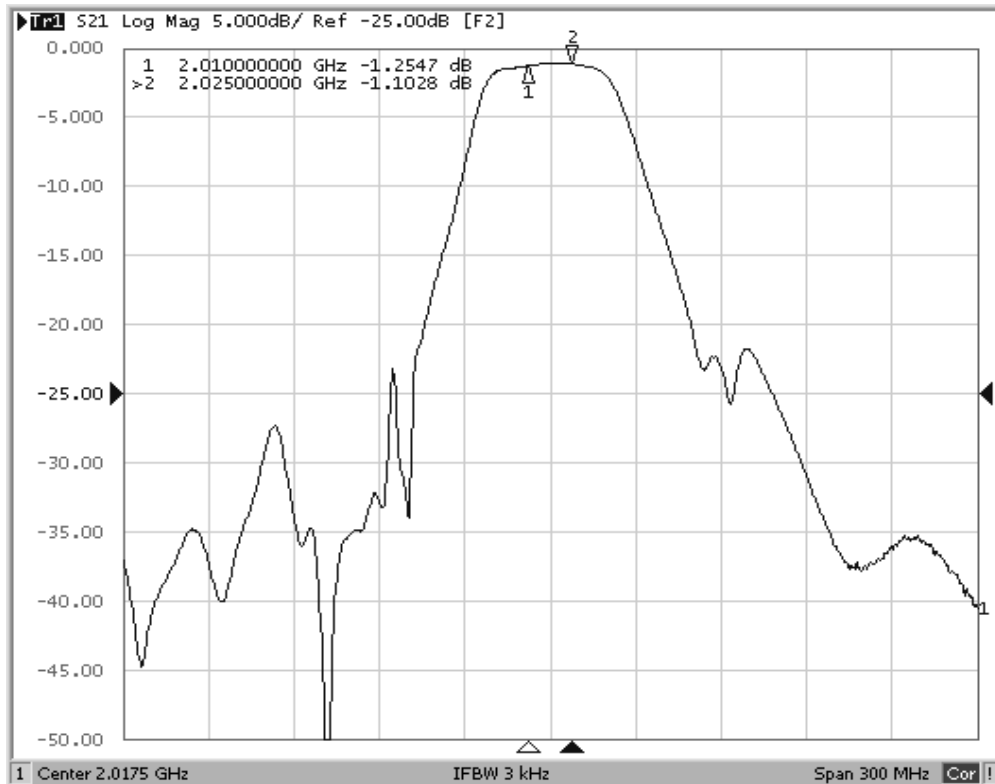

## Input VSWR Plot



## Output VSWR Plot

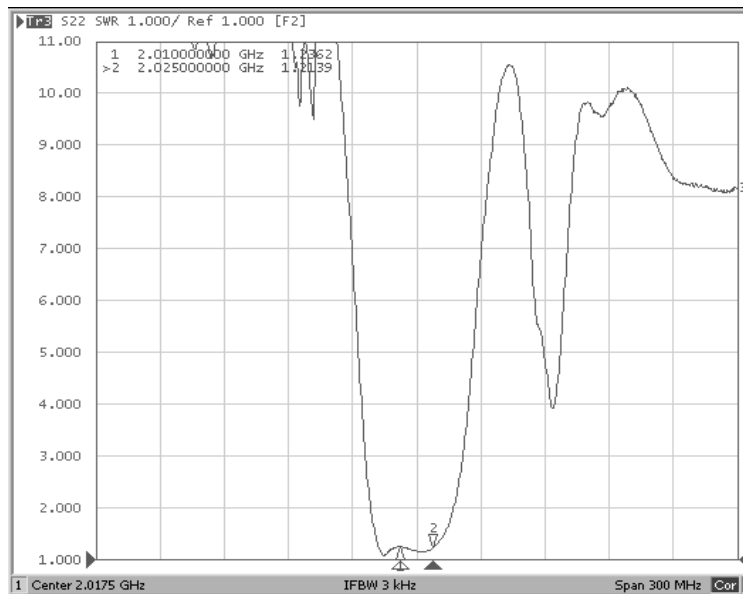

# SM2016-4 Case

## 4-Terminal Ceramic Surface-Mount Case

### 2.0 X 1.6 mm Nominal Footprint

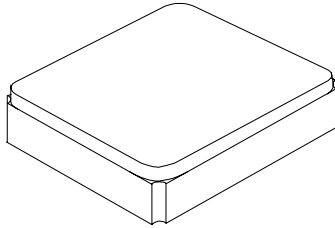

PCB PAD LAYOUT

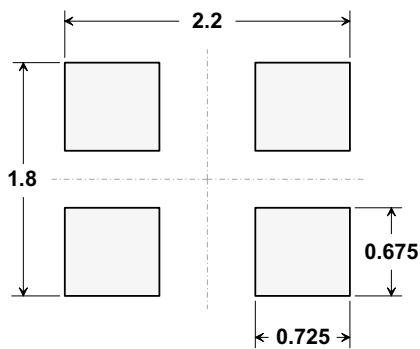

Dimensions in mm  
All pads have the same dimensions

#### Electrical Connections

Connection	Terminals
Input	1
Output	3
Ground	2, 4

Dimensions	Millimeters			Inches		
	Min	Nom	Max	Min	Nom	Max
A		1.60				
B		2.00				
C		0.90				
D		0.10				
E		0.10				
F		0.70				
G		0.50				
H		0.10				

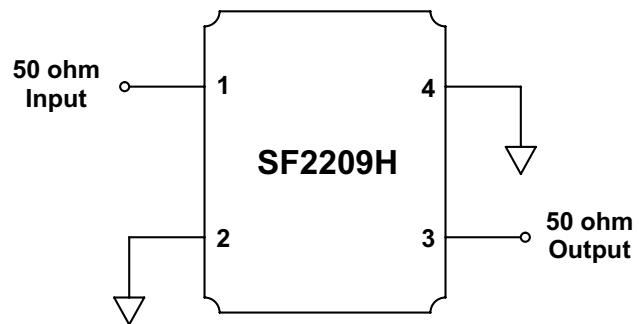

TOP VIEW

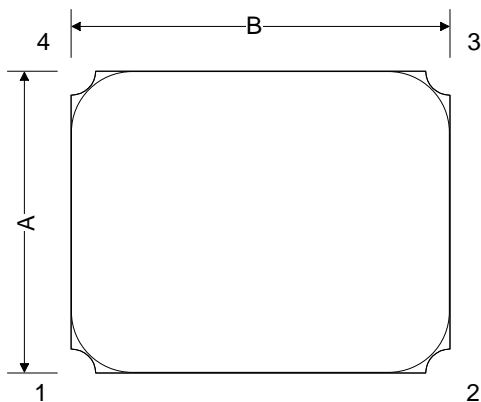

SIDE VIEW

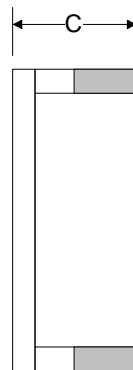

BOTTOM VIEW

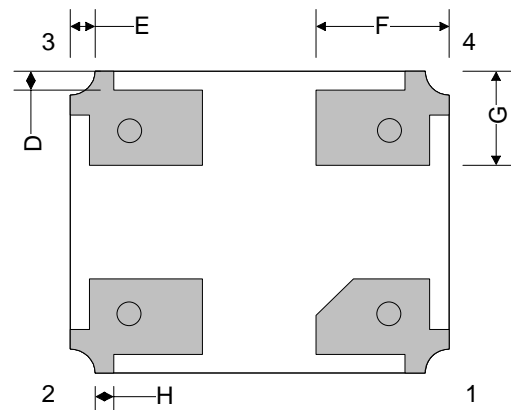

# Reel Dimensions - 7 inch Reel, 3000 Filters

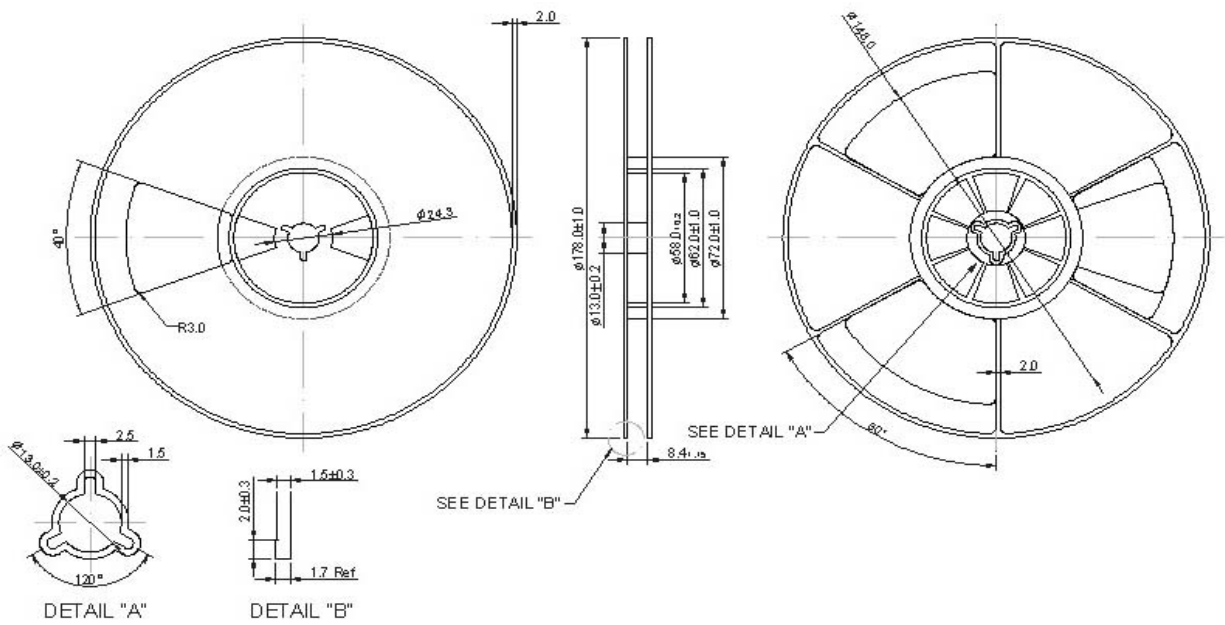

# Tape Dimensions

